

**Description**

The AP5727 is a high efficiency boost converter in a compact SOT25 that provides the bias voltages for OLED Sub Display and TFT-LCD (Liquid Crystal Display). A high 1.2MHz switching frequency and internal compensation minimizes external part count, PCB area and cost. Integrated soft start reduces inrush current. The AP5727 has a 1.25V feedback voltage making it compatible with industry standard boost converters used to bias LCD panels.

**Pin Assignments**

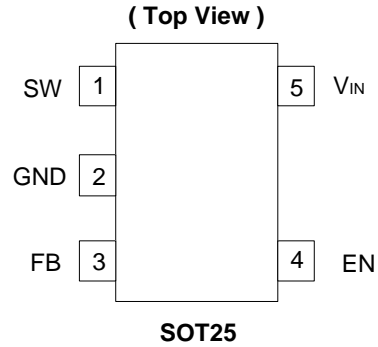

**Features**

- 30V High Output Voltage
- Fast **1.2MHz** Switching Frequency
- Current limit and UVLO Protections
- Internal Thermal Shutdown
- Maximum 1µA Shutdown Current
- Integrated Soft-start Function
- SOT25: Available in “Green” Molding Compound (No Br, Sb)
- Lead Free Finish/RoHS Compliant (Note 1)

**Applications**

- Small size TFT-LCD Bias power supply.
- OLED bias supply for a clamshell handset sub display
- RF amplifier bias voltages

Notes: 1. EU Directive 2002/95/EC (RoHS). All applicable RoHS exemptions applied. Please visit our website at [http://www.diodes.com/products/lead\\_free.html](http://www.diodes.com/products/lead_free.html).

**Typical Application Circuit**

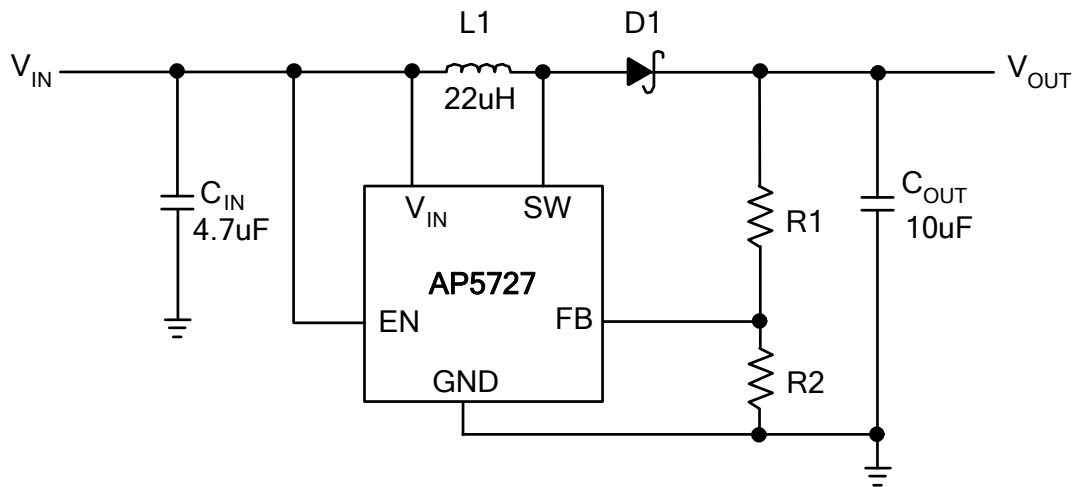

**Figure 1. Typical Application Circuit**

**Functional Block Diagram**

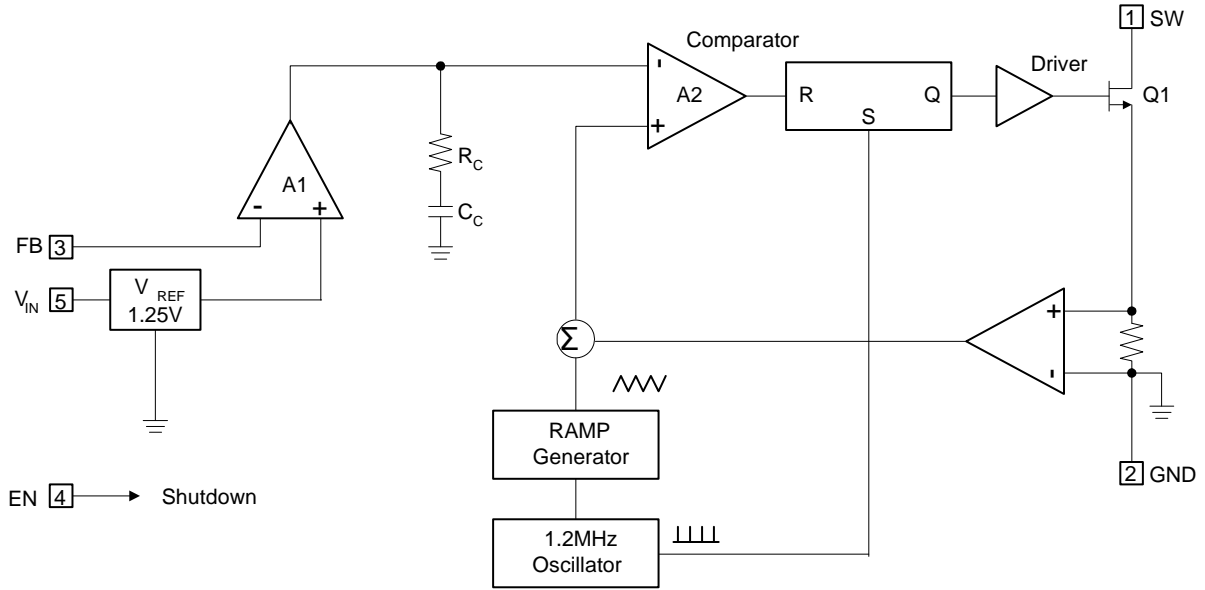

**Figure 2. Block Diagram**

**Pin Descriptions**

Name	Description
SW	Switch Pin. Connect inductor/diode here. Minimize trace area at this pin to reduce EMI.
GND	GND pin
FB	Feedback Pin. Reference voltage is 1.25V.
EN	Regulator On/Off Control Input. A high input at EN turns on the converter, and a low input turns it off. When not used, connect EN to the input source for automatic startup. The EN pin cannot be left floating.
V <sub>IN</sub>	Input Supply Pin. Must be locally decoupled - 4.7μF recommended to reduce input noise.

### Absolute Maximum Ratings (T<sub>A</sub> = 25°C)

Symbol	Parameter	Rating	Unit
V <sub>IN</sub>	VIN Pin Voltage	-0.3~7	V
V <sub>SW</sub>	SW Voltage	-0.3~32	V
V <sub>FB</sub>	Feedback Pin Voltage	-0.3~7	V
EN	EN	-0.3~7	V
T <sub>J(MAX)</sub>	Maximum Junction Temperature	150	°C
T <sub>LEAD</sub>	Lead Temperature	300	°C
T <sub>ST</sub>	Storage Temperature Range	-65 to +150	°C

Caution: The absolute maximum ratings are rated values exceeding which the product could suffer physical damage. These values must therefore not be exceeded under any condition.

### Recommended Operating Conditions

Symbol	Parameter	Min	Max	Unit
V <sub>IN</sub>	Input Voltage	2.7	5.5	V
T <sub>J</sub>	Operating Junction Temperature	-40	125	°C
T <sub>A</sub>	Operating Ambient Temperature	-40	85	°C

### Electrical Characteristics (V<sub>IN</sub> = 3.6V, T<sub>A</sub> = 25°C, unless otherwise specified)

Symbol	Parameter	Conditions	Min.	Typ.	Max.	Unit
<b>System Supply Input</b>						
V <sub>IN</sub>	Operating Input Voltage		2.7	-	5.5	V
UVLO	Under Voltage Lockout		-	2.2	2.4	V
	Under Voltage Lockout Hysteretic		-	85	-	mV
I <sub>Q</sub>	Quiescent Current	FB=1.3V, No Switching	-	500	-	μA
I <sub>SD</sub>	Shutdown Current	V <sub>EN</sub> < 0.4V	-	0.1	1	μA
<b>Oscillator</b>						
F <sub>OSC</sub>	Operation Frequency		1	1.2	1.4	MHz
D <sub>max</sub>	Maximum Duty Cycle		86	90	-	%
<b>Reference Voltage</b>						
V <sub>FB</sub>	Feedback Voltage		1.225	1.25	1.275	V
I <sub>FB</sub>	FB Pin Bias Current		10	45	100	nA
<b>MOSFET</b>						
R <sub>DS(on)</sub>	On Resistance of MOSFET		-	0.95	1.2	Ω
I <sub>OC</sub>	Switching Current Limit	Normal Operation	-	750	-	mA
<b>Control and Protection</b>						
EN	Voltage High	ON	1.5	-	-	V
EN	Voltage Low	OFF	-	-	0.4	V
I <sub>EN</sub>	EN Pin Pull Low Current		-	4	6	μA
θ <sub>JA</sub>	Thermal Resistance Junction-to-Ambient	SOT25 (Note 2)		162		°C/W
θ <sub>JC</sub>	Thermal Resistance Junction-to-Case	SOT25 (Note 2)		36		°C/W

Notes: 2. Test condition for SOT25: Device mounted on FR-4 substrate, single-layer PC board, 2oz copper, with minimum recommended pad layout

**Typical Performance Characteristics ( $V_{IN} = 3.3V$ ;  $V_{OUT} = 15V$   $I_{OUT} = 20mA$ )**

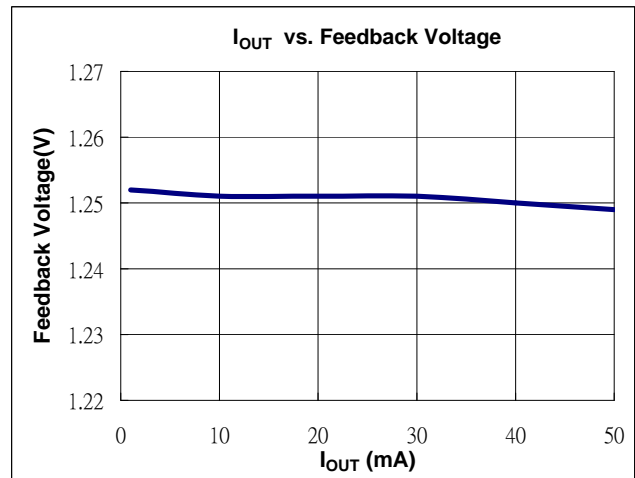
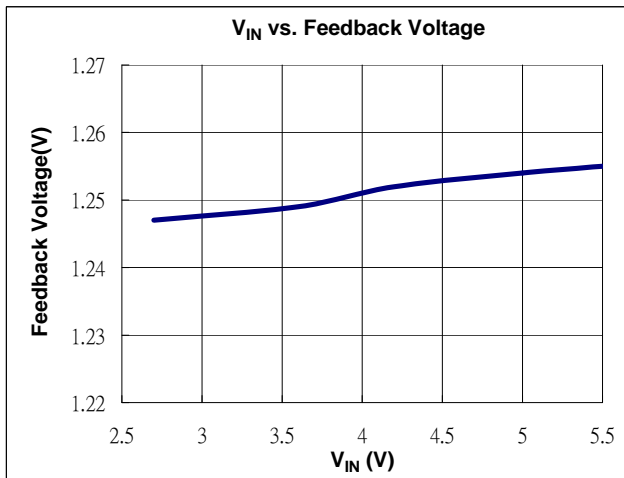
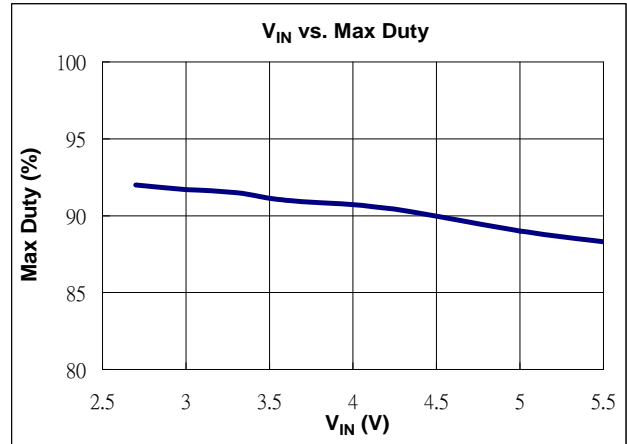
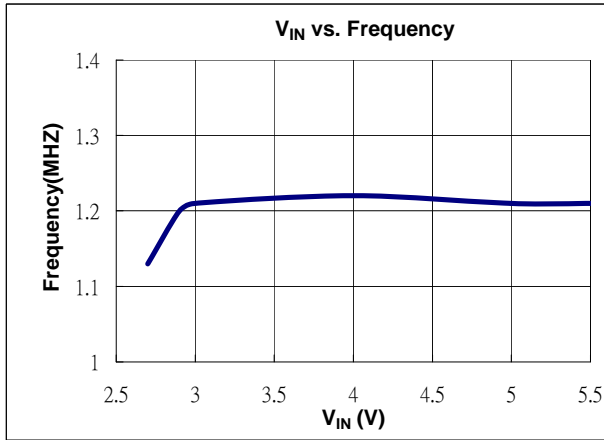
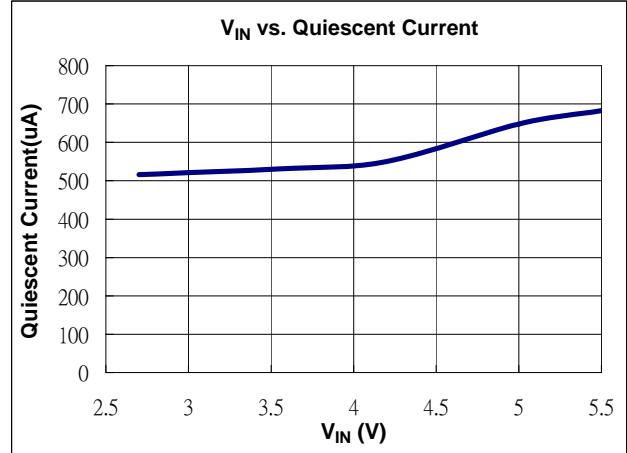
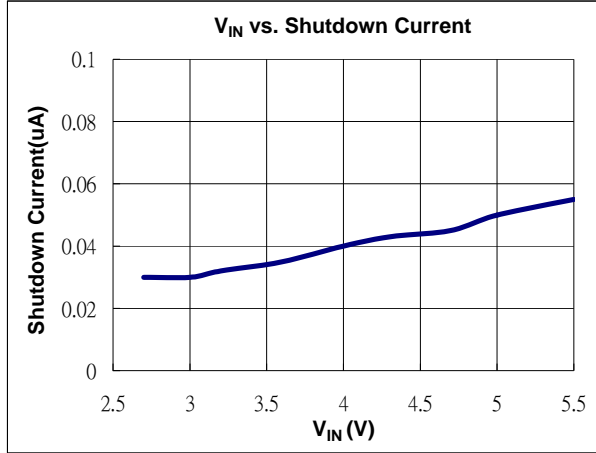

**Typical Performance Characteristics ( $V_{IN} = 3.3V$ ;  $V_{OUT} = 15V$   $I_{OUT} = 20mA$ )**

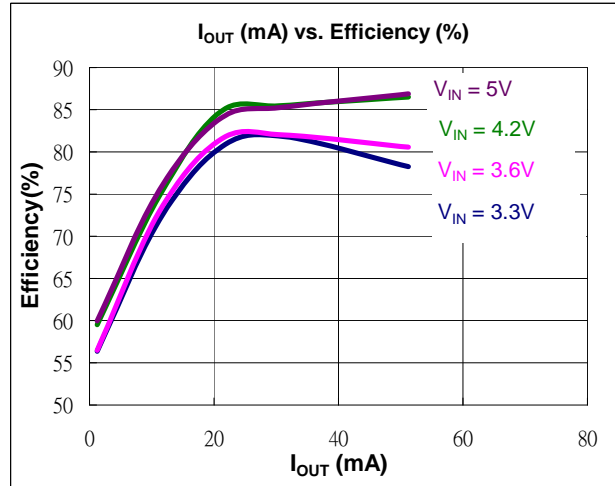
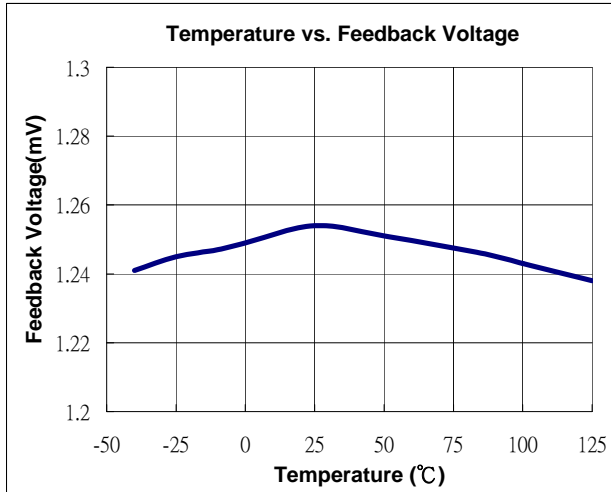
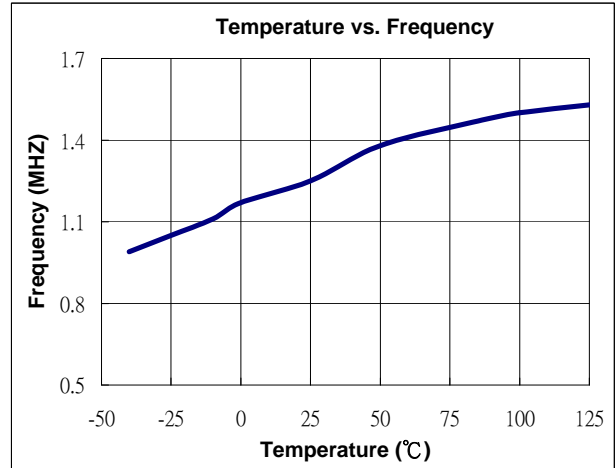
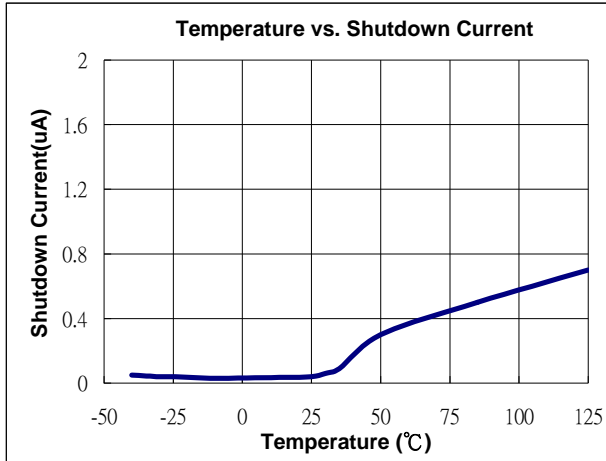

**Typical Performance Characteristics (Continued)**

**V<sub>OUT</sub> Ripple**  
**V<sub>IN</sub> = 3.3V; V<sub>OUT</sub> = 15V ; I<sub>OUT</sub> = 5mA**

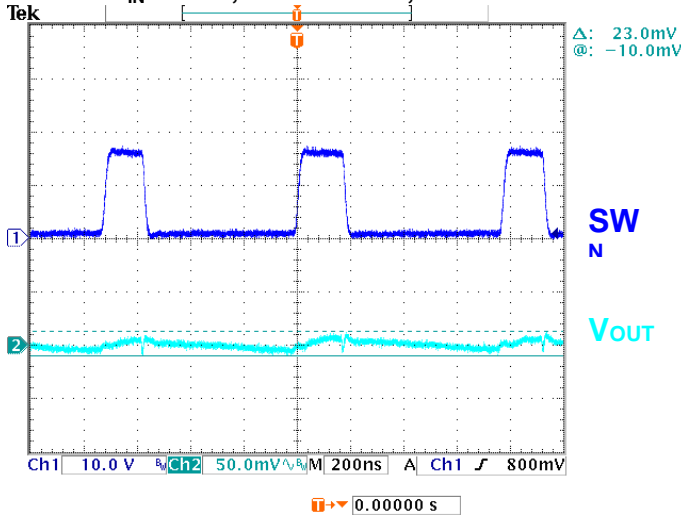

**V<sub>OUT</sub> Ripple**  
**V<sub>IN</sub> = 3.3V; V<sub>OUT</sub> = 15V ; I<sub>OUT</sub> = 50mA**

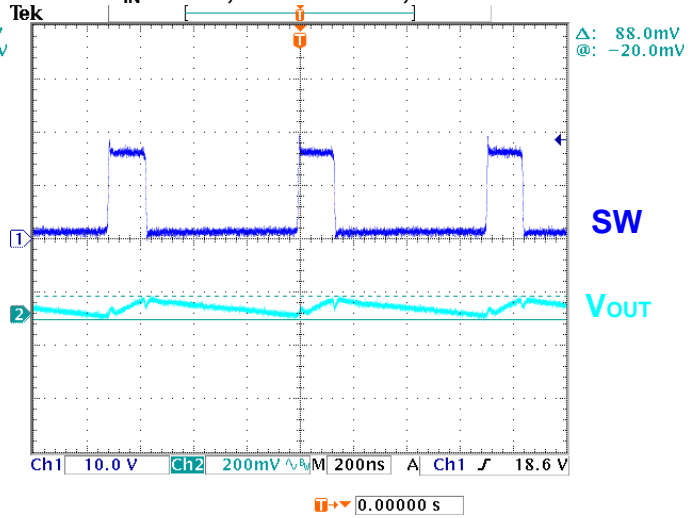

**POWER ON**  
**V<sub>IN</sub> = 3.3V; V<sub>OUT</sub> = 15V ; I<sub>OUT</sub> = 50mA**

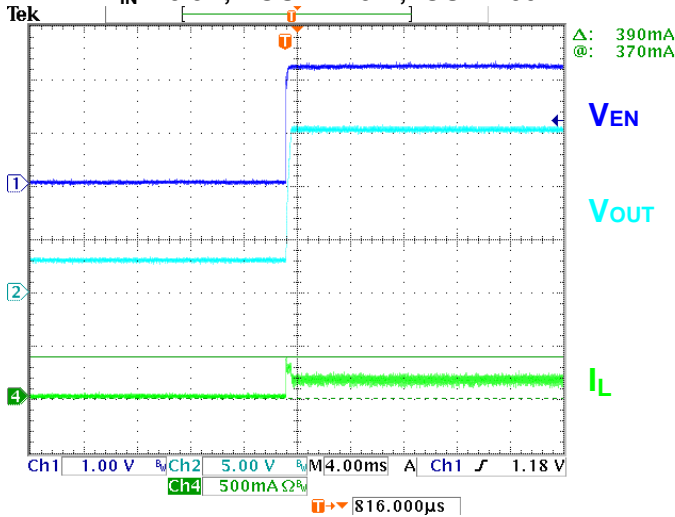

**POWER OFF**  
**V<sub>IN</sub> = 3.3V; V<sub>OUT</sub> = 15V ; I<sub>OUT</sub> = 50mA**

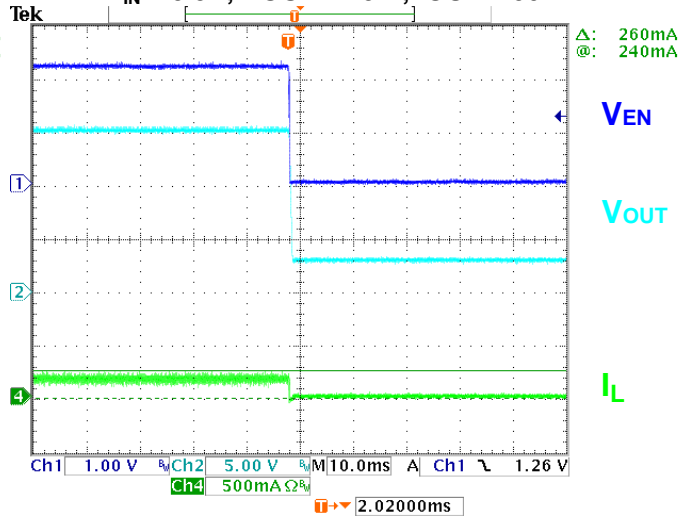

**Typical Performance Characteristics (Continued)**

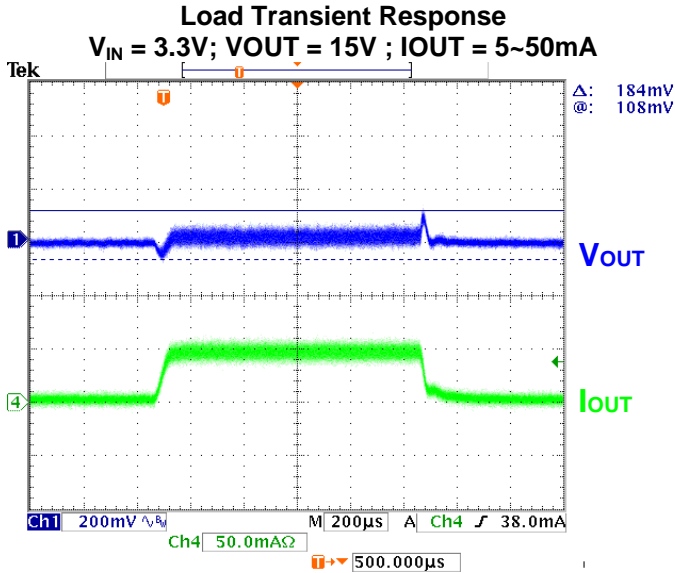

**Application Information**

**Inductor Selection**

A 10µH~22µH inductor is recommended for most AP5727 applications. Although small size and high efficiency are major concerns, the inductor should have low core loss at 1.2MHz and low DCR.

**Capacitor Selection**

Ceramic capacitors, due to their small size, are ideal for AP5727 applications. X5R and X7R types are recommended because they retain their capacitance over wider voltage and temperature ranges than other types such as X5R and X7R. A 4.7µF input capacitor and a 10µF output capacitor are sufficient for most AP5727 applications.

**Diode Selection**

Schottky diodes, with their low forward voltage drop and fast reverse recovery, are the ideal choices for AP5727 applications. The forward voltage drop of a Schottky diode represents the conduction loss in the diode, while the diode capacitance ( $C_T$ ) represents the switching loss. For diode selection, both forward voltage drop and diode capacitance need to be considered. Schottky diodes with higher current ratings usually have lower forward voltage drop and larger diode capacitance, which can cause significant switching loss at the 1.2MHz switching frequency of the AP5727.

**Application Circuit**

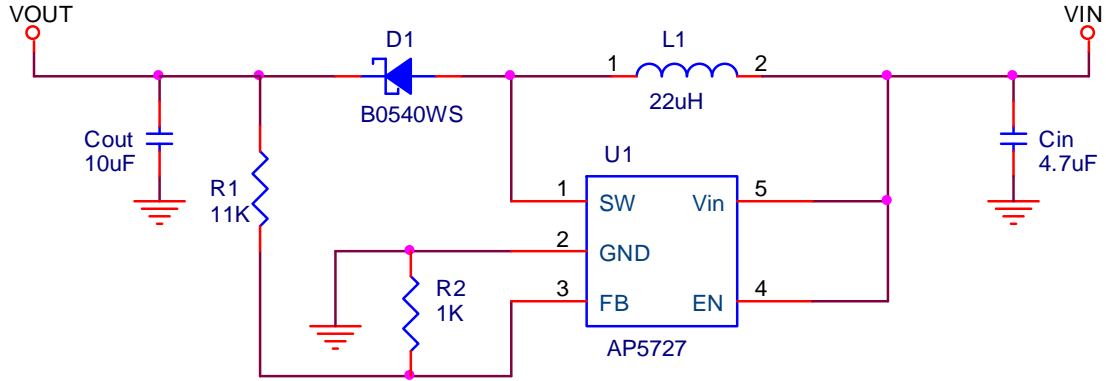

**Table 1. Suggested Inductors**

Vendor	Inductors (uH)	Current Rating (A)	Type	Dimensions (mm)	Series
Würth Electronics	22	0.51A	SMD	3.8X 3.8 X 1.6	744031220
GOTREND	22	0.56A	SMD	3.8 X 3.8 X 1.05	GLP3810PH220N
TAIYO YUDEN	22	0.51A	SMD	4.0 X 4.0 X 1.25	NR4012

**Table 2. Suggested Capacitors for C<sub>IN</sub> and C<sub>OUT</sub>**

Vendor	Capacitance	Type	Series
TAIYO YUDEN	4.7uF	SMD	LMK316 B7 475KL-T
TAIYO YUDEN	10uF	SMD	LMK316 F 106ZL-T

**Table 3. Suggested Diodes**

Vendor	Rating	Type	Series
ZETEX	40V/0.5A	SOD323	ZLLS400
DIODES	40V/0.5A	SOD323	B0540WS
DIODES	40V/0.25A	SOD523	SDM20U40

**Table 4. Suggested Resistor**

Vendor	Type	Series
YAGEO	SMD	FR-SK

**Ordering Information**

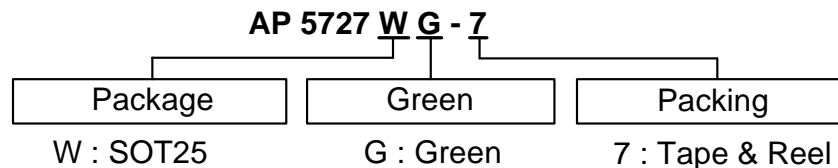

Device	Package Code	Packaging (Note 3)	7" Tape and Reel	
			Quantity	Part Number Suffix
AP5727WG-7	W	SOT25	3000/Tape & Reel	-7

Note: 3. Pad layout as shown on Diodes Inc. suggested pad layout document AP02001, which can be found on our website at <http://www.diodes.com/datasheets/ap02001.pdf>.



**Marking Information**

(1) SOT25

( Top View )

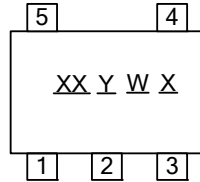

XX : Identification Code  
 Y : Year 0~9  
 W : Week : A~Z : 1~26 week;  
 a~z : 27~52 week; z represents  
 52 and 53 week  
 X : A~Z : Green

Part Number	Package	Identification Code
AP5727	SOT25	H8

**Package Outline Dimensions (All Dimensions in mm)**

(1) Package Type: SOT25

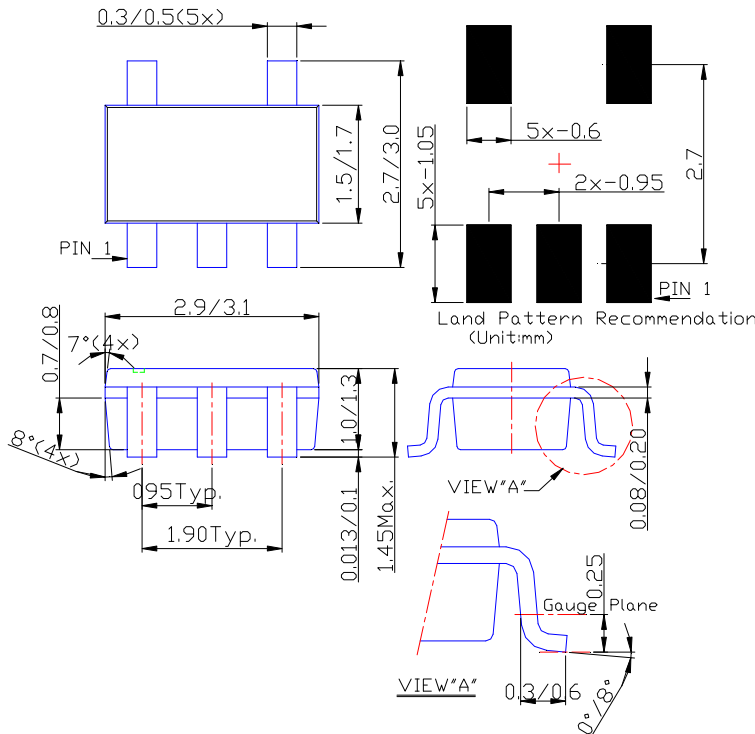

**IMPORTANT NOTICE**

DIODES INCORPORATED MAKES NO WARRANTY OF ANY KIND, EXPRESS OR IMPLIED, WITH REGARDS TO THIS DOCUMENT, INCLUDING, BUT NOT LIMITED TO, THE IMPLIED WARRANTIES OF MERCHANTABILITY AND FITNESS FOR A PARTICULAR PURPOSE (AND THEIR EQUIVALENTS UNDER THE LAWS OF ANY JURISDICTION).

Diodes Incorporated and its subsidiaries reserve the right to make modifications, enhancements, improvements, corrections or other changes without further notice to this document and any product described herein. Diodes Incorporated does not assume any liability arising out of the application or use of this document or any product described herein; neither does Diodes Incorporated convey any license under its patent or trademark rights, nor the rights of others. Any Customer or user of this document or products described herein in such applications shall assume all risks of such use and will agree to hold Diodes Incorporated and all the companies whose products are represented on Diodes Incorporated website, harmless against all damages.

Diodes Incorporated does not warrant or accept any liability whatsoever in respect of any products purchased through unauthorized sales channel.

Should Customers purchase or use Diodes Incorporated products for any unintended or unauthorized application, Customers shall indemnify and hold Diodes Incorporated and its representatives harmless against all claims, damages, expenses, and attorney fees arising out of, directly or indirectly, any claim of personal injury or death associated with such unintended or unauthorized application.

Products described herein may be covered by one or more United States, international or foreign patents pending. Product names and markings noted herein may also be covered by one or more United States, international or foreign trademarks.

**LIFE SUPPORT**

Diodes Incorporated products are specifically not authorized for use as critical components in life support devices or systems without the express written approval of the Chief Executive Officer of Diodes Incorporated. As used herein:

A. Life support devices or systems are devices or systems which:

1. are intended to implant into the body, or
2. support or sustain life and whose failure to perform when properly used in accordance with instructions for use provided in the labeling can be reasonably expected to result in significant injury to the user.

B. A critical component is any component in a life support device or system whose failure to perform can be reasonably expected to cause the failure of the life support device or to affect its safety or effectiveness.

Customers represent that they have all necessary expertise in the safety and regulatory ramifications of their life support devices or systems, and acknowledge and agree that they are solely responsible for all legal, regulatory and safety-related requirements concerning their products and any use of Diodes Incorporated products in such safety-critical, life support devices or systems, notwithstanding any devices- or systems-related information or support that may be provided by Diodes Incorporated. Further, Customers must fully indemnify Diodes Incorporated and its representatives against any damages arising out of the use of Diodes Incorporated products in such safety-critical, life support devices or systems.

Copyright © 2010, Diodes Incorporated

[www.diodes.com](http://www.diodes.com)