

AXICOM

Telecom-, Signal and RF Relays

Reed V23100-V4 Relay

Reed V23100-V4 Relay

Disclaimer

While Tyco Electronics has made every reasonable effort to ensure the accuracy of the information in this datasheet, Tyco Electronics does not guarantee that it is error-free, nor does Tyco Electronics make any other representation, warranty or guarantee that the information is accurate, correct, reliable or current. Tyco Electronics reserves the right to make any adjustments to the information contained herein at any time without notice. Tyco Electronics expressly disclaims all implied warranties (and all express warranties, except as otherwise stated in this datasheet) regarding the information contained herein, including but not limited to any implied warranties or merchantability or fitness for a particular purpose. It is recommended that you test any new or replacement product before incorporating into a system.

The dimensions in this datasheet are for reference purpose only and are subject to change without notice. Specifications are subject to change without notice.

Index

Relay Types	3
DIP Version (flat)	4
DIP Version (high)	6
SIL Version	8
Mini SIL Version	10
Contact Data	11
Insulation	11
General Data	11
High Frequency Data	11



Reed V23100-V4 Relay

1 and 2 pole relays
non-polarized, non-latching

ROHS compliant (Directive 2002/95/EC) as per product date code 0501.

Features

- Direct coil control with TTL-signals possible
- Highly reliable switching
- High switching rates
- Ultrasonic cleanable
- High vibration and shock resistance

Typical applications

- Incircuit tester
- Measuring and control systems
- Telecom equipment
- Alarm and security equipment

Relay Types

DIP version (flat)

- Standard version
- Electrostatic shield between coil and contact
- Protective diode
- Electrostatic shield and protective diode
- Contact arrangement:
1 form a (1 normally open contact) or
1 form c (1 changeover contact)

DIP version (high)

- Standard version
- Electrostatic shield between coil and contact
- Protective diode
- Electrostatic shield and protective diode
- Contact arrangement:
2 form a (2 normally open contacts) or
1 form c (1 changeover contact)

SIL version

- Standard version
- Protective diode
- Contact arrangement:
1 form a (1 normally open contact)

Mini SIL version

- Standard version
- Protective diode
- Standard internal magnetic shield
- Contact arrangement:
1 form a (1 normally open contact)

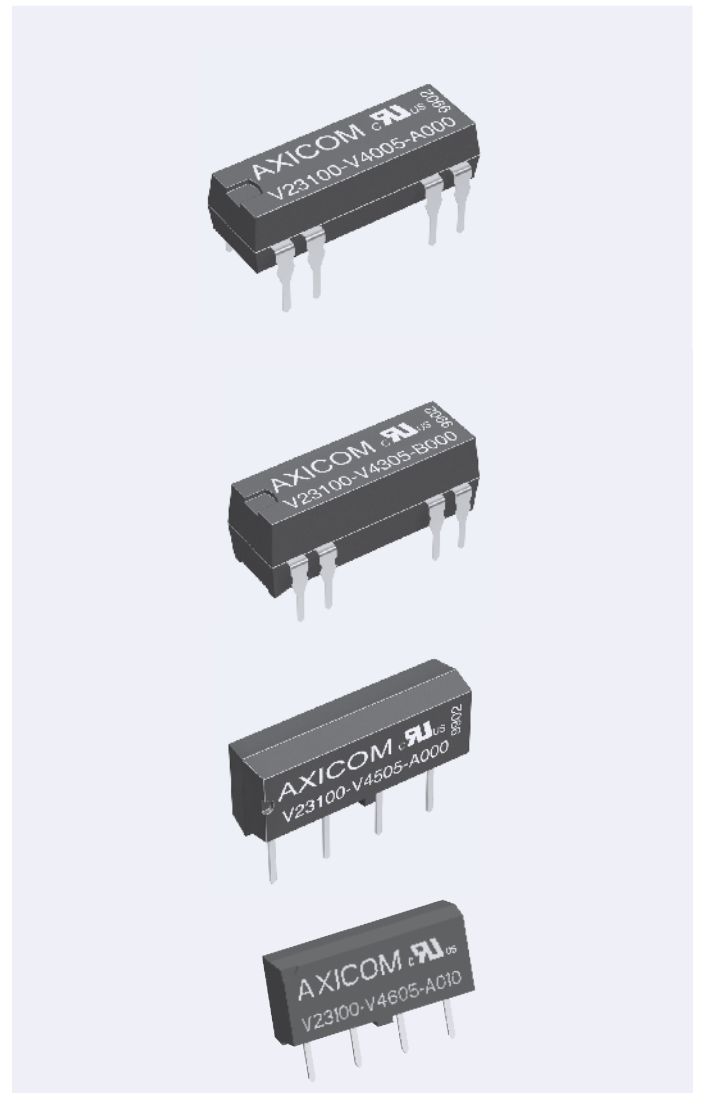

Reed V23100-V4 Relay

Dimensions

Dimensions in mm

DIP version (flat)

DIP flat version		
	mm	inch
L	19.30 - 0.2	0.760 - 0.008
W	6.40 - 0.2	0.252 - 0.008
H	5.70 - 0.2	0.224 - 0.008
Hb	5.10 - 0.2	0.201 - 0.008
T	3.20 ± 0.1	0.126 ± 0.004
Tw	0.50 ± 0.1	0.020 ± 0.004
Tz	0.25 ± 0.1	0.010 ± 0.004

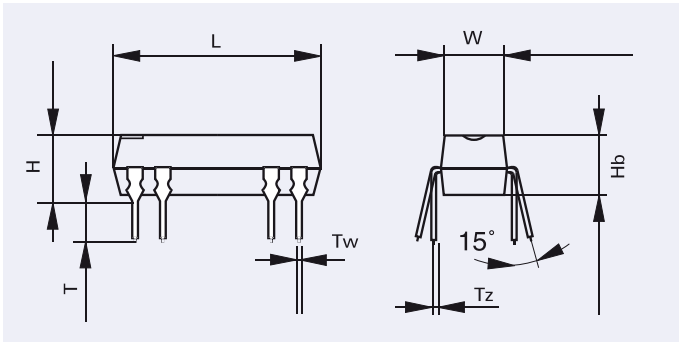
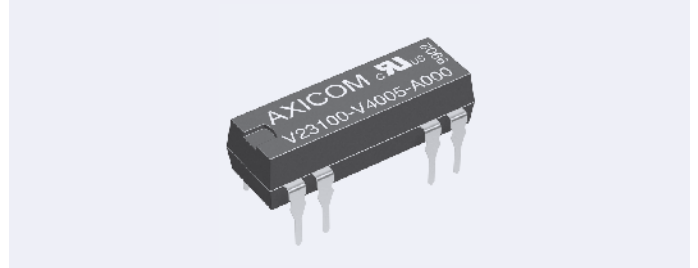

Mounting hole layout

Top view

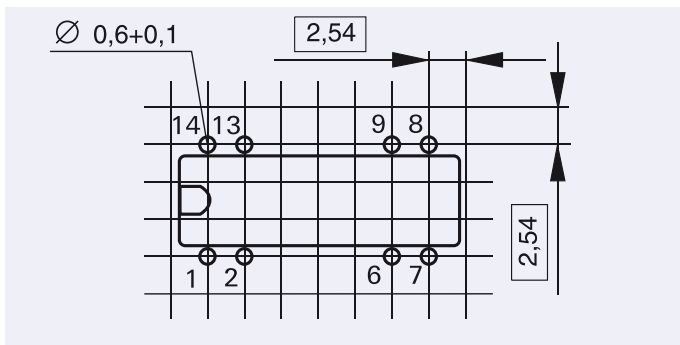

Terminal assignment

Top view

1 form a
standard

1 form a
with diode

1 form a
with electrostatic
shield and diode

1 form c
standard

1 form a
with electrostatic
shield

A000

A010

A011

C000

A001

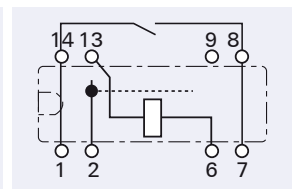
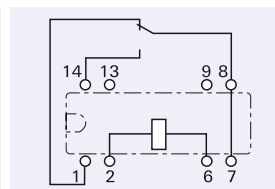
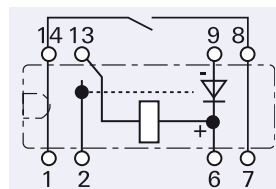
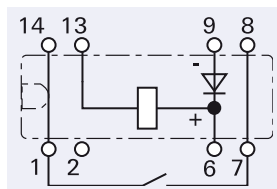
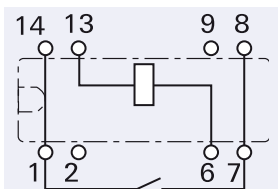

Reed V23100-V4 Relay

Coil Data (values at 23 °C)

Ordering Information

Nominal voltage U_{nom}	Operate/set voltage range		Release/ reset voltage Minimum	Coil power	Coil Resistance	Relay code	Tyco part number
	Minimum voltage U_{min}	Maximum voltage U_{max}					
Vdc	Vdc	Vdc	Vdc	mW	$\Omega / \pm 10\%$		

DIP version flat: 1 form a contact, standard

5	3.5	22	0.75	50	500	V23100-V4005-A000	1393763-1
12	8.4	33	1.80	144	1000	V23100-V4012-A000	1393763-6
15	10.5	44	2.25	112	2000	V23100-V4015-A000	1-1393763-0
24	16.8	44	3.60	288	2000	V23100-V4024-A000	1-1393763-4

DIP version flat: 1 form a contact, with diode

5	3.5	14	0.75	50	500	V23100-V4005-A010	1393763-4
12	8.4	25	1.80	144	1000	V23100-V4012-A010	1393763-8
15	10.5	47	2.25	112	2000	V23100-V4015-A010	1-1393763-2
24	16.8	47	3.60	288	2000	V23100-V4024-A010	1-1393763-6

DIP version flat: 1 form c contact, standard

5	3.5	13 (14.5)*	0.75	125	200	V23100-V4305-C000	2-1393763-0
12	8.4	22 (23.5)*	1.80	288	500	V23100-V4312-C000	2-1393763-8
15	10.5	44 (14.5)*	2.25	112	2000	V23100-V4315-C000	3-1393763-4
24	16.8	44 (49.0)*	3.60	288	2000	V23100-V4324-C000	4-1393763-0

DIP version flat: 1 form a contact, with electrostatic shield

5	3.5	22	0.75	50	500	V23100-V4005-A001	1393763-3
12	8.4	33	1.80	144	1000	V23100-V4012-A001	1393763-7
15	10.5	44	2.25	112	2000	V23100-V4015-A001	1-1393763-1
24	16.8	44	3.60	288	2000	V23100-V4024-A001	1-1393763-5

DIP version flat: 1 form a contact, with electrostatic shield and diode

5	3.5	14	0.75	50	200	V23100-V4005-A011	1393763-3
12	8.4	25	1.80	144	1000	V23100-V4012-A011	1393763-9
15	10.5	47	2.25	112	2000	V23100-V4015-A011	1-1393763-3
24	16.8	47	3.60	288	2000	V23100-V4024-A011	1-1393763-7

* Values in brackets refer to high relay with protective diode

Relay Code

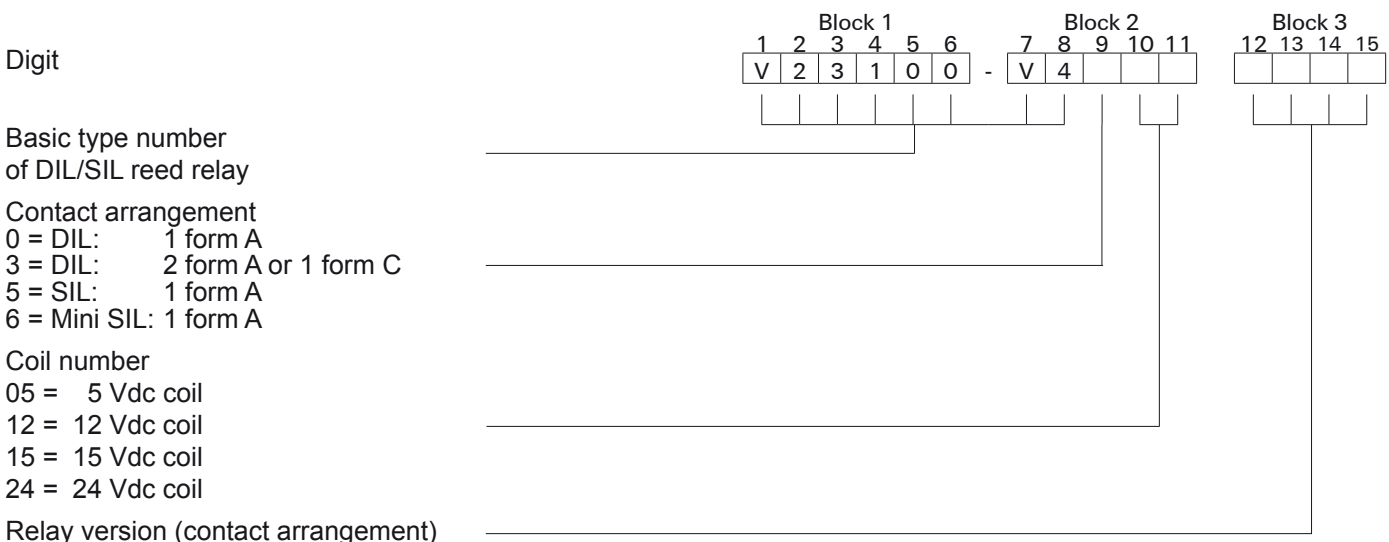

Ordering example: V23100-V4005-A010 DIL reed relay with 1 make, 5 V nominal voltage, with clamping diode (spark suppression)

Reed V23100-V4 Relay

Dimensions

Dimensions in mm

DIP version (high)

DIP-high version		
	mm	inch
L	19.30 - 0.2	0.760 - 0.008
W	7.00 - 0.2	0.276 - 0.008
H	7.50 - 0.2	0.295 - 0.008
S	0.50 ± 0.1	0.200 ± 0.004
T	3.20 ± 0.1	0.126 ± 0.004
Tw	0.50 ± 0.1	0.020 ± 0.004
Tz	0.25 ± 0.1	0.010 ± 0.004

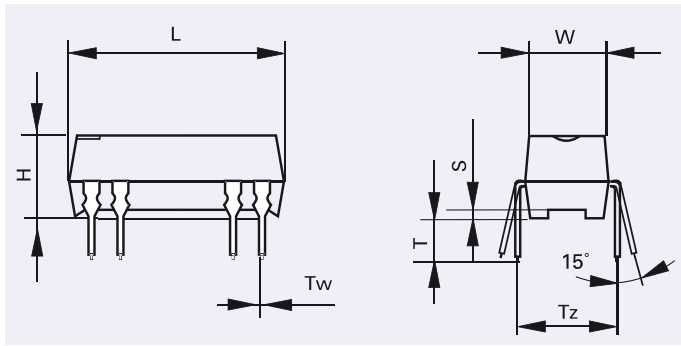
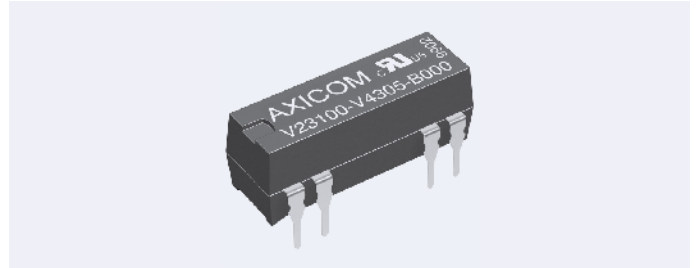

Mounting hole layout

Top view

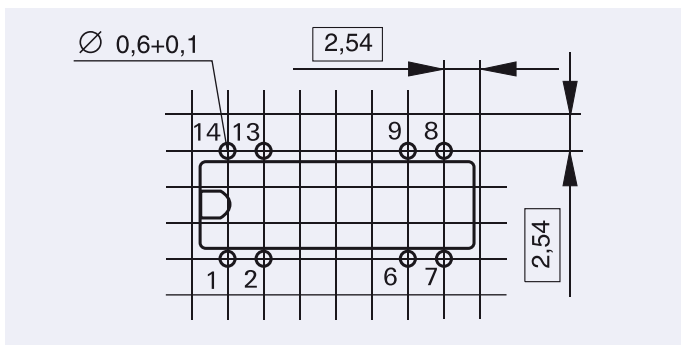

Terminal assignment

Top view

2 form a
standard

1 form c
with diode

2 form a
with diode

1 form c
with electrostatic
shield and diode

B000

C010

B010

C011

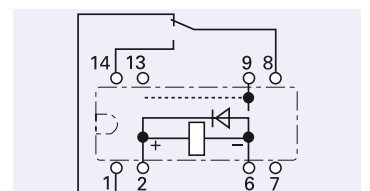
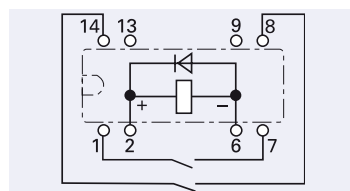
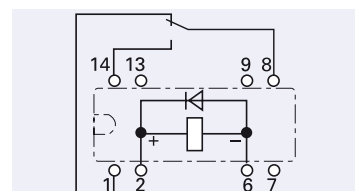
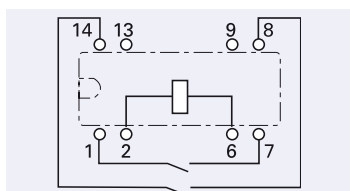

Reed V23100-V4 Relay

Coil Data (values at 23 °C)

Ordering Information

Nominal voltage U_{nom}	Operate/set voltage range		Release/ reset voltage Minimum	Coil power	Coil Resistance	Relay code	Tyco part number
	Minimum voltage U_{min}	Maximum voltage U_{max}					
Vdc	Vdc	Vdc	Vdc	mW	$\Omega / \pm 10\%$		

DIP version high: 2 form a contact, standard

5	3.5	14	0.75	125	200	V23100-V4305-B000	1-1393763-8
12	8.4	25	1.80	288	500	V23100-V4312-B000	2-1393763-6
15	10.5	47	2.25	112	2000	V23100-V4315-B000	3-1393763-2
24	16.8	47	3.60	288	2000	V23100-V4324-B000	3-1393763-8

DIP version high: 2 form a contact, with diode

5	3.5	14	0.75	125	200	V23100-V4305-B010	1-1393763-9
12	8.4	25	1.80	288	500	V23100-V4312-B010	2-1393763-7
15	10.5	47	2.25	112	2000	V23100-V4315-B010	3-1393763-3
24	16.8	47	3.60	288	2000	V23100-V4324-B010	3-1393763-9

DIP version high: 1 form c contact, with diode

5	3.5	14.5	0.75	125	200	V23100-V4305-C010	2-1393763-2
12	8.4	23.5	1.80	288	500	V23100-V4312-C010	3-1393763-0
15	10.5	14.5	2.25	112	2000	V23100-V4315-C010	3-1393763-6
24	16.8	49.0	3.60	288	2000	V23100-V4324-C010	4-1393763-2

DIP version high: 1 form c contact, with diode and electrostatic shield

5	3.5	14.5	0.75	125	200	V23100-V4305-C011	2-1393763-3
12	8.4	23.5	1.80	288	500	V23100-V4312-C011	3-1393763-1
15	10.5	14.5	2.25	112	2000	V23100-V4315-C011	3-1393763-7
24	16.8	49.0	3.60	288	2000	V23100-V4324-C011	4-1393763-3

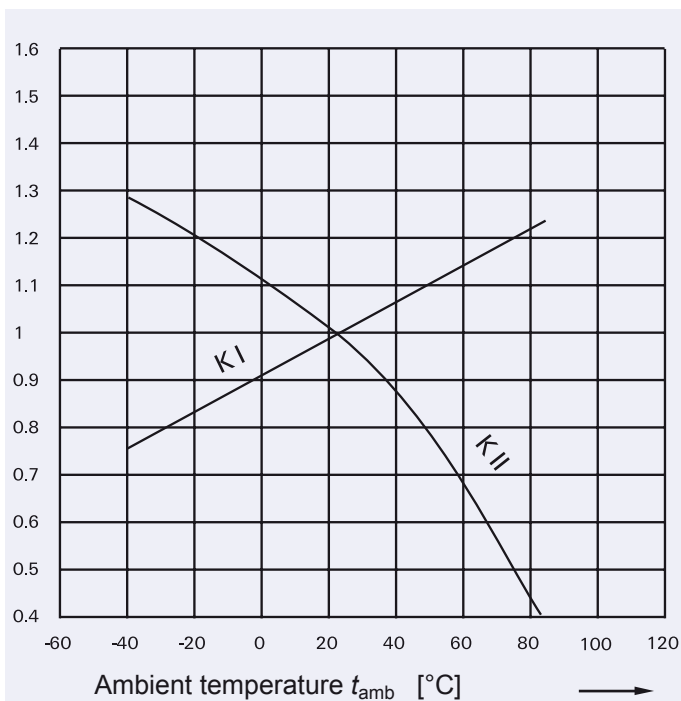

U_I = Minimum voltage at 23 °C after preenergizing with nominal voltage without contact current

U_{II} = Maximum continuous voltage at 23 °C

The operating voltage limits U_I and U_{II} depend on the temperature according to the formula:

$$U_{I \text{ t amb}} = K_I \cdot U_{I \text{ 23 }^\circ\text{C}}$$

and

$$U_{II \text{ t amb}} = K_{II} \cdot U_{II \text{ 23 }^\circ\text{C}}$$

t_{amb} = Ambient temperature

$U_{I \text{ t amb}}$ = Minimum voltage at ambient temperature, t_{amb}

$U_{II \text{ t amb}}$ = Maximum voltage at ambient temperature, t_{amb}

k_I, k_{II} = Factors (dependent on temperature), see diagram

Reed V23100-V4 Relay

Dimensions

Dimensions in mm

SIL version

SIL version		
	mm	inch
L	19.80 - 0.2	0.780 - 0.008
W	5.08 - 0.2	0.200 - 0.008
H	7.80 - 0.2	0.307 - 0.008
T	3.50 ± 0.2	0.138 ± 0.008
Tw	0.60 ± 0.1	0.024 ± 0.004
Tz	0.25 ± 0.1	0.010 ± 0.004

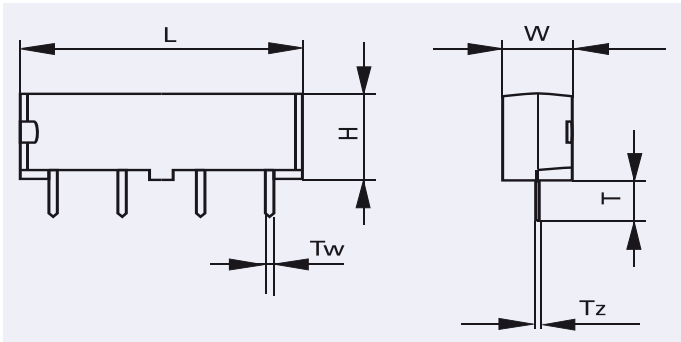
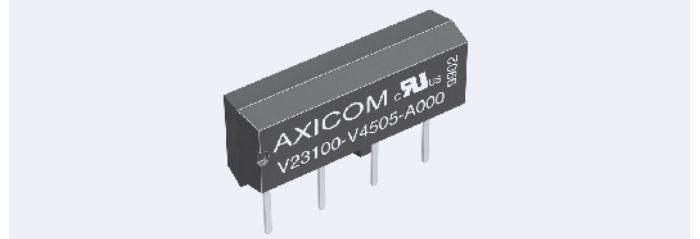

Mounting hole layout

Top view

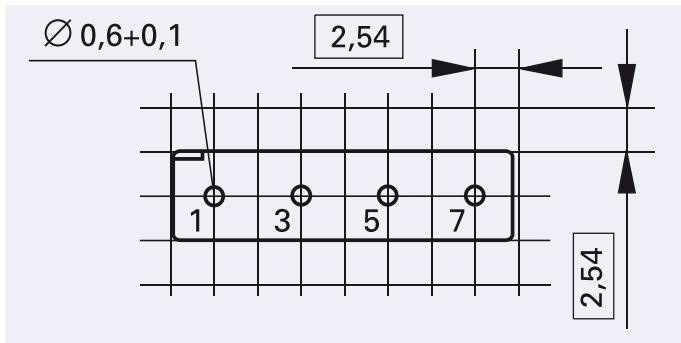

Terminal assignment

Top view

1 form a
standard

1 form a
with diode

A000

A010

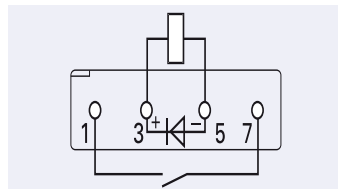
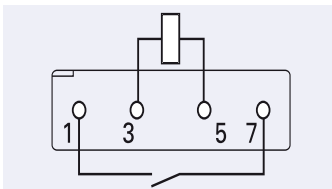

Reed V23100-V4 Relay

Coil Data (values at 23 °C)

Ordering Information

Nominal voltage U_{nom}	Operate/set voltage range		Release/ reset voltage Minimum	Coil power	Coil Resistance	Relay code	Tyco part number
	Minimum voltage U_{min}	Maximum voltage U_{max}					
Vdc	Vdc	Vdc	Vdc	mW	$\Omega / \pm 10\%$		

SIL version: 1 form a contact

5	3.5	22	0.75	50	500	V23100-V4505-A000	4-1393763-4
12	8.4	33	1.80	144	1000	V23100-V4512-A000	4-1393763-7
15	10.5	44	2.25	112	2000	V23100-V4515-A000	4-1393763-9
24	16.8	44	3.60	288	2000	V23100-V4524-A000	5-1393763-1

SIL version: 1 form a contact with diode

5	3.5	22	0.75	50	500	V23100-V4505-A010	4-1393763-5
12	8.4	33	1.80	144	1000	V23100-V4512-A010	4-1393763-8
15	10.5	44	2.25	112	2000	V23100-V4515-A010	5-1393763-0
24	16.8	44	3.60	288	2000	V23100-V4524-A010	5-1393763-2

Reed V23100-V4 Relay

Dimensions

Dimensions in mm

Mini SIL version

SIL version		
	mm	inch
L	15.20 - 0.2	0.780 - 0.008
W	3.80 - 0.2	0.200 - 0.008
H	6.80 - 0.2	0.307 - 0.008
T _w	0.50 ± 0.1	0.024 ± 0.004
T _z	0.25 ± 0.1	0.010 ± 0.004

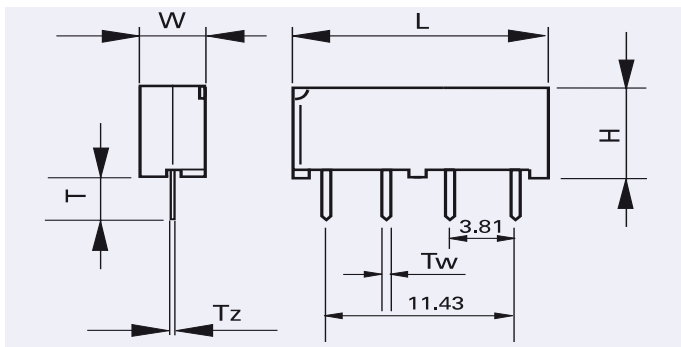
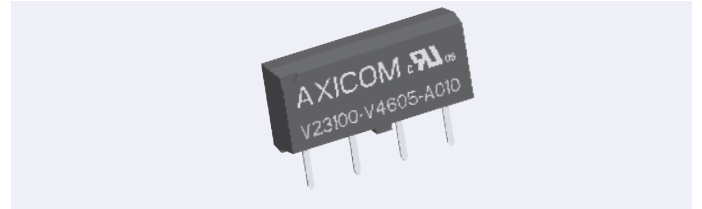

Mounting hole layout

Top view

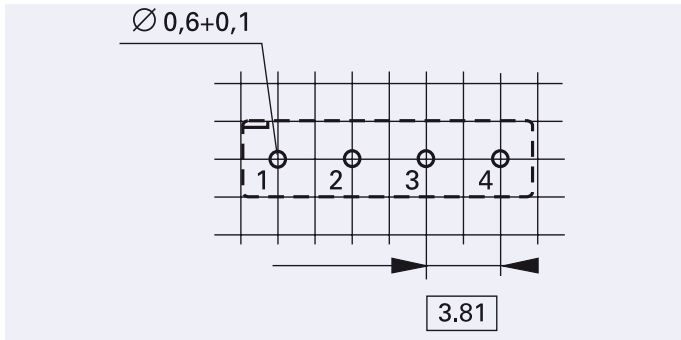

Terminal assignment

Top view

1 form a standard

A000

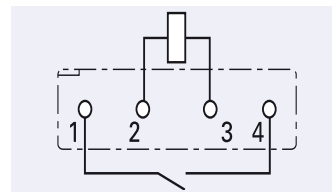

1 form a with diode

A010

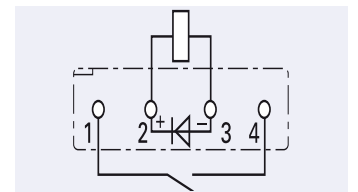

Coil Data (values at 23 °C)

Ordering Information

Nominal voltage U_{nom}	Operate/set voltage range		Release/ reset voltage Minimum	Coil power	Coil Resistance	Relay code	Tyco part number
	Minimum voltage U_{min}	Maximum voltage U_{max}					
Vdc	Vdc	Vdc	Vdc	mW	$\Omega \pm 10\%$		
5	3.5	13.6	0.75	50	500	V23100-V4605-A000	1422026-2
12	8.4	21.6	1.80	205	700	V23100-V4612-A000	1422026-3

SIL version: 1 form a contact

5	3.5	13.6	0.75	50	500	V23100-V4605-A010	1422026-5
12	8.4	21.6	1.80	205	700	V23100-V4612-A010	1422026-6

SIL version: 1 form a contact with diode

5	3.5	13.6	0.75	50	500	V23100-V4605-A010	1422026-5
12	8.4	21.6	1.80	205	700	V23100-V4612-A010	1422026-6

Reed V23100-V4 Relay

Contact Data

Type of relay	DIP version			SIL version	Mini SIL Version
Type of contact/s	1 form a	2 form a	1 form c	1 form a	1 form a
Contact material	Ruthenium				
Maximum continuous current	1 A		1.2 A	1 A	1 A
Maximum switching current	0.5 A		0.25 A	0.5 A	0.5 A
Maximum switching voltage at nominal voltage: 5 Vdc 12-24 Vdc	200 Vdc / Vac peak 200 Vdc / Vac peak		175 Vdc 175 Vdc peak	200 Vdc / Vac 200 Vdc / Vac	200 Vdc / Vac peak 200 Vdc / Vac peak
Maximum switching capacity					
DC voltage	10 W		3 W	10 W	10 W
AC voltage	10 VA		3 VA	10 VA	10 VA
Initial contact resistance / measuring condition:	<150 mΩ				
Electrical endurance	at 12 V / 10 mA at 24 V / 400 mA		5 x 10 ⁷ 5 x 10 ⁶		

Insulation

Insulation resistance at 500 Vdc	contact coil > 10 ⁹ Ω			
Dielectric test voltage (1 min)				
contact / coil	1500 Vdc	1500 Vdc	1500 Vdc	1500 Vdc
contact / contact	250 Vdc	200 Vdc	250 Vdc	225 Vdc

High Frequency Data

Capacitance	
between coil and contacts	max. 2 pF
between adjacent contact sets	max. 1 pF
between open contacts	max. 1 pF

General Data

Type of relay	DIP version			SIL version	Mini SIL Version
Type of contact/s	1 form a	2 form a	1 form c	1 form a	1 form a
Maximum operate time (including bounce)	0.75 ms		1.1 ms	0.75 ms	0.75 ms
Maximum release time	0.15 ms		1.6 ms	0.15 ms	0.15 ms
Operating temperature range	-40 °C ... +85 °C				
Storage temperature	-40 °C ... +95 °C				
Thermal resistance	Approx. 75 K / W				
Maximum permissible coil temperature	105 °C				
Vibration resistance (function)	30 G 10 to 2000 Hz		30 G 50 to 2000 Hz	30 G 10 to 2000 Hz	30 G 10 to 2000 Hz
Shock resistance, half sinus, 11 ms	150 G		50 G	150 G	50 G
Degree of protection	immersion cleanable, IP 67				
Mounting position	any				
Resistance to soldering heat	265 °C / 10 s				

Reed V23100-V4 Relay

IM Relays

4th generation slim line – low profile polarized 2 c/o telecom signal relay with bifurcated contacts, available as non latching or latching relay with 1 coil. Nominal voltage range from 1.5 ... 24 V, coil power consumption of 50 ... 200 mW, latching relays with 1 coil 100 mW. The IM relay is available as through hole and surface mount type (J-Legs and Gull Wings) and capable to switch loads up to 60 W/62,5 VA. It is currently the only 2 A rated 4G relay on the market. Dielectric strength fulfills the Telcordia requirements according GR 1089 (2,5 kV – 2 / 10 μ s) and FCC part 68 (1,5 kV – 10 / 160 μ s). The IM relay is tested according CECC/IECQ and certified in accordance with IEC/EN 60950 and UL 60950.

Dimensions approx. 10 x 6 mm board space and 5.65 mm height.

P2 Relays

3rd generation polarized 2 c/o telecom relay with bifurcated contacts, available as non latching or latching relay with 1 or 2 coils. Nominal voltage range from 3 ... 24 V, coil power consumption 140 mW, latching relays with 1 coil 70 mW. The P2 Relay is available as through hole or surface mount type and capable to switch currents up to 5 A. Dielectric strength fulfills the Telcordia requirements according GR 1089 (2,5 kV – 2 / 10 μ s) and FCC part 68 (1,5 kV – 10 / 160 μ s). The P2 relay is tested according CECC/IECQ and certified in accordance with IEC/EN 60950 and UL 60950. Dimensions approx. 15 x 7,5 mm board space and 10 mm height.

FX2 Relays

3rd generation polarized 2 c/o telecom relay with bifurcated contacts, available as non latching or latching relay with 1 coil. Nominal voltage range from 3 ... 48 V, coil power consumption of 80 ... 260 mW for the high sensitive version, 140... 300 mW for the standard version, latching relays with 1 coil 100 mW. The FX2 relay is available as through hole type and capable to switch loads up to 60 W/62,5 VA. Dielectric strength fulfills the Telcordia requirements according GR 1089 (2,5 kV – 2 / 10 μ s) and FCC part 68 (1,5 kV – 10 / 160 μ s). The FX2 relay is tested according CECC/IECQ and certified in accordance with IEC/EN 60950 and UL 60950. Dimensions approx. 15 x 7,5 mm board space and 10,7 mm height.

FT2 / FU2 Relays

3rd generation non polarized, non latching 2 c/o telecom relay with bifurcated contacts. Nominal voltage range from 3 ... 48 V, coil power consumption 200 ... 300 mW. Most sensitive 48 V relay. Available as through hole and surface mount type. Dielectric strength fulfills the Telcordia requirements according GR 1089 (2,5 kV – 2 / 10 μ s) and FCC part 68 (1,5 kV – 10 / 160 μ s). The FT2/FU2 relay is tested according CECC/IECQ and certified in accordance with IEC/EN 60950 and UL 60950. Dimensions approx. 15 x 7,5 mm board space and 10 mm height.

FP2 Relays

3rd generation polarized 2 c/o telecom relay with bifurcated contacts, available as non latching or latching relay with 1 or 2 coils. Nominal voltage range from 3 ... 48 V, coil power consumption of 80 ... 260 mW for the high sensitive version, 140... 300 mW for the standard version, latching relays with 1 coil 100 mW. The FP2 Relay is available as through hole type and capable to switch loads up to 60 W/62,5 VA. Dielectric strength fulfills FCC part 68 (1,5 kV – 10 / 160 μ s). The FP2 is tested according CECC/IECQ approved.

Dimensions approx. 14 x 9 mm board space and 5 mm height.

MT2

2nd generation non polarized, non latching 2 c/o telecom and signal relay with bifurcated contacts. Nominal voltage range from 3 ... 48 V, coil power consumption 150/200/300/400 and 550 mW. Dielectric strength fulfills the requirements according FCC part 68 (1,5 kV – 10 / 160 μ s).

Dimensions approx. 20 x 10 mm board space and 11 mm height.

D2n Relays

2nd generation non polarized 2 c/o relay for telecom and various other applications. Nominal voltage range from 3 ... 48 V, coil power consumption from 150 ... 500 mW. The D2n relay is capable to switch currents up to 3 A. Dielectric strength fulfills the requirements according FCC part 68 (1,5 kV – 10 / 160 μ s). Dimensions approx. 20 x10 mm board space and 11 mm height.

P1 Relays

Extremely sensitive, polarized 1 c/o relay with bifurcated contacts for a wide range of applications, available as non latching or latching relay with 1 or 2 coils. Nominal voltage range from 3 ... 24 V, coil power consumption 65 mW, latching relays with 1 coil 30 mW. The P1 relay is available as through hole or surface mount type and capable to switch currents up to 1 A. Dielectric strength fulfills the requirements according FCC part 68 (1,5 kV – 10 / 160 μ s). Dimensions approx. 13 x 7,6 mm board space and 7 mm height for THT or 8 mm height for SMT version.

W11 Relays

Low cost, non polarized 1 c/o relay for various applications. Nominal voltage range from 3 ... 24 V, coil power consumption 450 mW, sensitive versions 200 mW. The W11 relay is capable to switch currents up to 3 A. Dielectric strength 1000 Vrms.

Dimensions approx. 15,6 x 10,6 mm board space and 11,5 mm height.

Reed Relays

High sensitive, non polarized relay for telecom and various other applications, available with 1 n/o, 2 n/o or 1c/o contacts. Nominal voltage range from 5 ... 24 V, coil power consumption 50...280 mW for 1 n/o and 125 ... 280 mW for 2 n/o or 1 c/o versions. Reedrelays are available in DIP or SIL housing and capable to switch currents up to 0,5 A. Integrated diode and/or electrostatic shield optional. Dielectric strength 1500 Vdc. Dimensions approx. 19,3 x 7 mm board space and 5 ... 7,5 mm height for DIP or 19,8 x 5 mm board space and 7,8 mm height for SIL version.

Cradle Relays

Extremely reliable and mature relay family of 1st generation for various signal switching applications. Available as non polarized, polarized / latching and relay with AC coil. The benefit is the possibility of combining various contact sets from 1 up to 6 poles, single and bifurcated contacts, different contact materials with a coil voltage range from 1,5 Vdc to 220 Vac. Cradle relays are available as dust protected and hermetically sealed versions, with plug in or solder terminals and are capable to switch currents up to 5 A. Forcibly guided (linked) contact sets optional. Dielectric strength 500 Vrms. Dimensions from approx. 19 x 24 to 19x35 mm board space and 30 mm height.

Other Relays

We offer a variety of different relay families for maintenance and replacement purposes. These relays are up to 60 years old now, such as Card Relay SN (V23030 series), Small General Purpose Relay (V23006 series), Small Polarized Relay (V23063 ... V23067 and V23163 ... V23167 series). Accessories like sockets, hold down springs, etc. optional.

High Frequency Relays

HF3 / HF3S / HF6 series RF relays offering excellent RF characteristics in a small package. All HF series relays are suitable for SMD soldering processes. Available as non latching or latching versions with 1 or 2 coils and a nominal coil voltage range from 3 ... 24 V, a coil power consumption of 140 mW or 70 mW (single coil latching types).

HF3: Low cost RF relay suitable up to 3 GHz. Impedance 50 and 75 Ohm. 50 W hot switching and 50 W RF power carry capability. Dimensions 14.6 x 7.3 x 10.3 mm.

HF3S: High performance, high power RF relay suitable up to 3 GHz, 50 W hot switching and 150 W RF power carry capability. Dimensions 15 x 7.6 x 10.6 mm.

HF6: High performance, high power RF relay suitable up to 6 GHz, 50 W hot switching and 50 W RF power carry capability. Dimensions 15 x 7.6 x 10.6 mm.



Tyco Electronics Logistics AG
Werk Axicom Au
Seestrasse 295
CH-8804 Au-Wädenswil / Switzerland
Phone +41 44 782 91 11
Fax +41 44 782 90 00
E-mail: axicom@tycoelectronics.com



Tyco Electronics
Paulsternstrasse 26
D-13629 Berlin / Germany
Phone +49 30 386 38573
Fax +49 30 386 38575
E-mail: axicom@tycoelectronics.com



Tyco Electronics EC Trutnov s.r.o.
Komenského 821
CZ-541 01 Trutnov / Czech Republic
E-mail: axicom@tycoelectronics.com

AXICOM

Telecom-, Signal and RF Relays

Tyco Electronics Corporation
POB 3608,
Harrisburg, PA 17105, USA
Phone +1 800-522-6752

 **Tyco Electronics**

Our commitment. Your advantage.