

Test Probes
ICT / FCT
High Current
Cable and Plug Connectors
Assorted Applications

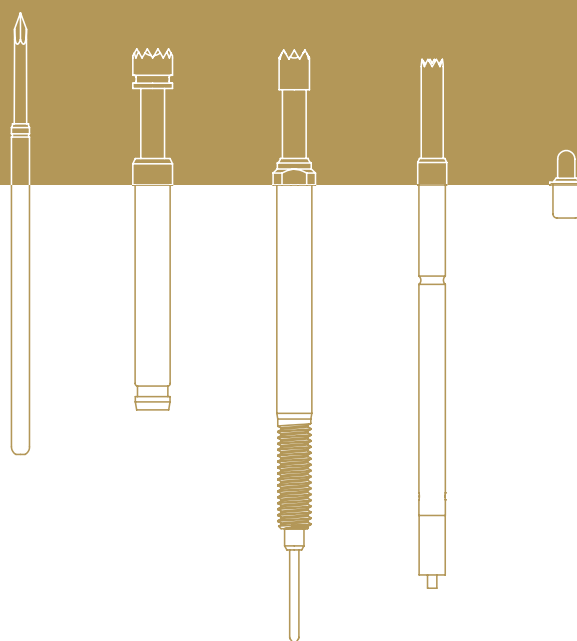

Competent in your field



Telecommunications



Information Electronics



Consumer Electronics



Automotive

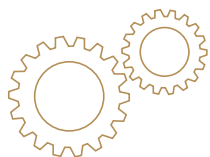

Engineering

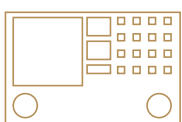

Tests and Measurements



Aviation and Space Technology



INGUN spring-loaded test probes are used by our customers in various industries, and enable a precise, accurately repeatable test of electronic assemblies to guarantee product quality and customer satisfaction.

As the leading company in testing, INGUN has the largest range of spring-loaded test probes worldwide. There is no doubt a spring-loaded test probe for your application too. If not, contact us for your customised contacting solution in renowned INGUN quality – Made in Germany.

You will find more information about INGUN, spring-loaded test probes, and their applications on pages 4 to 19.

INGUN Test Probes

Quality - Made in Germany

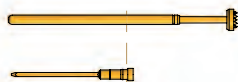
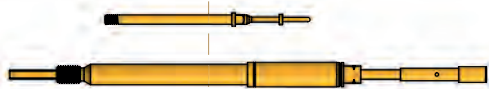
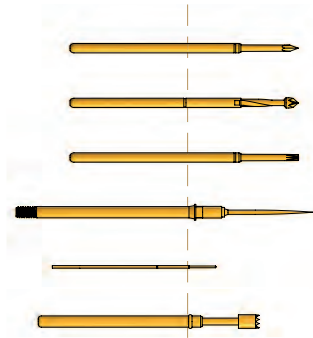

Product Information

Test Probes and Receptacles
Tip Styles
Design and Instruction for Use

ICT / FCT (In circuit test and function test)

International Standard GKS
(without collar)

INGUN E-TYPE®
Rotating Test Probe DKS

Bead Probe
Flying Probe

Fine Pitch

Metric Standard GKS
(with collar)

High Current Test Probes (Low ohm test probes)

Standard HSS
Short / long HSS

Dipole / Four-wire HSS
Robust HSS

Switching Probes

Press-in / Screw-in
Quick Exchange System

Screw- in Probes (Cable and plug connectors)

GKS with Thread
Step Probes

Push-back Probes (VF)
Non-rotating GKS

Dipole and RF Test Probes

Four-wire Measurement
PCB Layout
Plug Connectors

Pneumatic Test Probes

Pneumatic GKS
Pneumatic Switching
Probes

Assorted Test Probes

Short Stroke GKS
Charge and Transfer GKS
Solderable GKS

Accessories (GKS / test fixture)

Interface GKS
Contact Terminals
HMS / PCB Support GKS

Tools (GKS / KS)

Insertion / Extraction Tools
Torque Screwdrivers
Bit Inserts

INGUN – Quality through Precision



A family business with persuasive know-how

The family business, located in Constance at the Lake of Constance, has produced and sold test probes and test fixtures all over the world since 1971, and in that time developed into the number 1 company in testing technology.

INGUN products are manufactured exclusively at the German site under the slogan *Made in Germany* and delivered worldwide from there. With their high precision and established know-how, INGUN would like to continue to shape the future together with you.

Your competent partner since 1971

The path to success



1971	1976	1979	1995	2005	2007	2017
<ul style="list-style-type: none"> – “INGenieur UNion” (INGUN) – in English engineer union – founded in Konstanz by Werner H. Heilmann as a trading company for electronic components – Wolfgang Karl joins the company – 7 employees 	<ul style="list-style-type: none"> – INGUN launches their first radio frequency probe in May 1976 	<ul style="list-style-type: none"> – Introduction of the first vacuum test fixture manufactured in Germany at the Productronica trade fair in Munich 	<ul style="list-style-type: none"> – Fully automatic assembly of test probes – Certification in accordance with DIN EN ISO 9001 – 108 employees 	<ul style="list-style-type: none"> – Introduction of counterfeit protection for spring-loaded test probes – Now represented worldwide in 28 countries – 145 employees 	<ul style="list-style-type: none"> – Wolfgang Karl is appointed to board of directors – His son, Armin Karl, takes over management 	<ul style="list-style-type: none"> – Over 45 years of INGUN – Represented worldwide on every continent – 47 agencies – 10 subsidiaries – 350 employees

Worldwide in Contact



Your reliable partner worldwide

INGUN co-operates with over 45 agencies worldwide and is represented all over the world with their own subsidiaries. Many of their current agencies have worked together with the test equipment specialist since the company was founded.

Your local contact partner

Only those who understand their customers can offer the best products and services. The INGUN group can be reached via one of their many subsidiaries and agencies worldwide – one of which is guaranteed to be near you.

Find your local INGUN contact person today at: www.ingun.com/contact



The INGUN Product Finder - Find your test solution online!



- Find, compare & request over 11,000 products online
- Filter & limit search results
- See technical details & download data sheets

Visit our new website:

www.ingun.com

Product Information

All relevant information about test probes and receptacles is featured and explained on the **product information pages**.

INGUN offers an unbeatable range of spring-loaded test probes. Each **product number** has a defined key, which includes relevant information about tip style, tip diameter, spring force and material.

Depending on the electronic assembly and the test points to be contacted, various test probe **tip styles** are available.

The combination of the optimally selected test probe version and spring force enables precise, reliable and replicable contacting.

INGUN offers a range of tip styles for test points such as pads, vias, pins, posts and plug connectors.

All spring-loaded test probe have a similar **functional principle** with spring-loaded plungers and recommended working stroke.

The following points about test probes and receptacles are described precisely in the **design and instructions for use** section: assembly, available types of connection, hitting accuracy, current load capacity, drilling tolerances, life span and operating temperature range.

In order to fulfil the test requirements, a variety of **materials** are used. All relevant **environmental regulations** relating to the use of these materials are fulfilled.

Further important questions about test probes and receptacles are summarised in the **FAQs** section.

Product Information

Test Probes (product no.)	8
Tip Styles (selection)	9 - 11
Functional Principles	12 - 13
Design and Instructions for Use	14 - 17
Materials and Environment	18
FAQ	19

INGUN Test Probes

Products and Part Number

INGUN part numbers

Each INGUN **product number** has a defined key, which includes relevant information about the probe version i.e., series, grid size, tip style, tip diameter, spring force and material. Within each series, various combinations are possible and are shown on the respective page. After selecting the individual components, such as tip style, the order number can be derived using the following system:

GKS	-	100	2	91	090	A	20	00	C
1		2	3	4	5	6	7	8	9

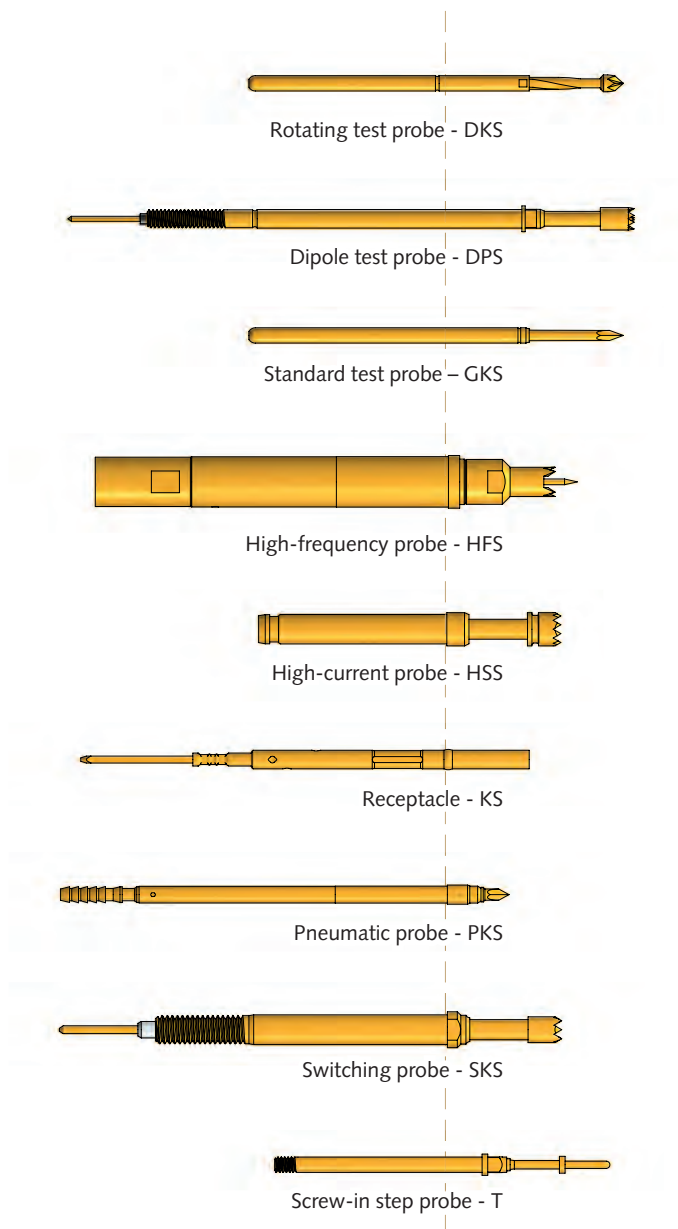

1	Type of product	DKS	Rotating test probe
		DPS	Dipole test probe
		DS	Spacer
		E	INGUN E-TYPE®
		GKS	Standard test probe
		HFS	High frequency probe
		HSS	High current probe
		HMS	Stroke-measuring probe
		KK	Contact clamp
		KS	Receptacle
		KT	Contact terminal
		PKS	Pneumatic probe
		PSK	Pneumatic switching probe
		SE	Plug
		SKS	Switching probe
		T	Screw-in step probe
		VF	Push-back probe
		VK	Four-wire clamp
		VS	Plug
2	Series		
3	Tip material	0 =	Nylon (e.g. Delrin)
		1 =	Brass
		2 =	Steel
		3 =	BeCu (Beryllium-Copper)
4	Tip style		see Tip Styles Overview
5	Tip diameter		in mm/100 (e.g. 090 = 0.9mm)
6	Plating	A =	Gold
		G =	Aurun
		N =	Nickel
		R =	Rhodium
		S =	Silver
7	Spring force		in N (Newton)/10 (e.g. 20 = 2.0N)
8	Collar height		Collar height of the barrel in mm 00 = no collar
9	Special designation		(e.g. "C" = heat-proof)

Choice of Suitable Tip Style

The choice of suitable tip style is one of the most important factors in choosing the right test probe. Many of the tip styles can be used for several applications. A basic classification can be made with respect to the geometry of the test points, such as pad, via, pin or posts. Furthermore, the test point can be differentiated by its size and surface condition

(oxidised, clean or contaminated by residue from the soldering process).

Depending on the DUT and test conditions, it may be necessary to try several tips styles and spring forces in order to find an optimal combination.

PADs

Contacting of flat test points on PCBs: To ensure the penetration of OSP or contaminated surfaces (residue from the soldering process), aggressive, self-cleaning tip styles (e.g., tip style 91: dagger) are recommended. Passive tip styles are used for clean surfaces and to avoid puncturing the surface (e.g., tip style 05, bullet-nosed). Note: In order to avoid damaging multi-layered PCBs, the penetration depth of the tip style in the external layer must be observed (especially when an aggressive tip style is used together with a high spring force).

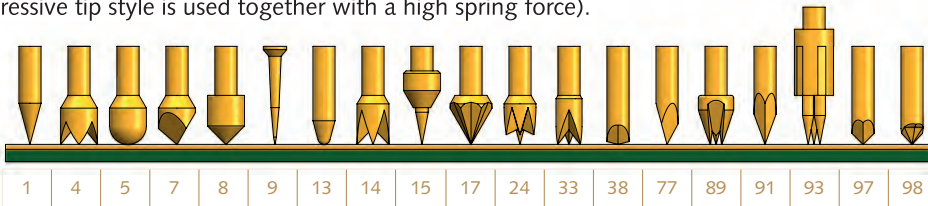

Most commonly used tip styles

VIAs

Vias can be contacted using the edge of a tip style on the inner surface of the ring, or with the point of a crown tip style vertically on the surface of the via.

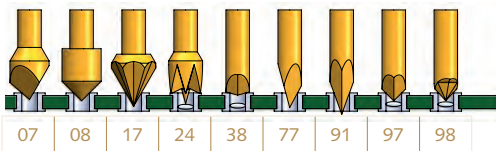

PINs

An optimally-centred inverse cone tip style is recommended for pins and component pins. Flat, pointed and tip styles with outer insulation are also possible for these kinds of test points.

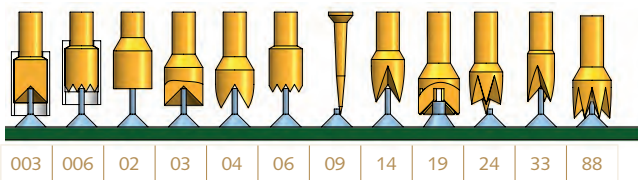

POSTS, screws and bolts

Self-centering tip styles, similar to those used for pins can be used for these kinds of test points

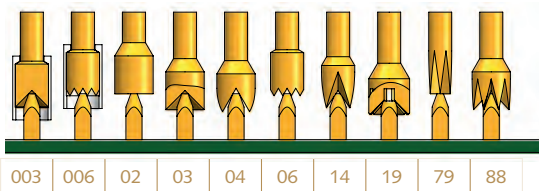

Tip style number	Contact point					Tip style			
	PAD	VIA	PIN	POSTS	clean	contaminated	passive	aggressive	self-cleaning
003			x	x	x		x		
006			x	x	x	x		x	
01	x				x	x		x	x
02			x	x	x		x		
03			x	x	x		x		
04	x		x	x	x	x		x	
05	x				x		x		
06			x	x	x	x		x	
07	x	x			x	x		x	x
08	x	x			x	x	x	x	x
09	x		x		x	x		x	x
13	x				x		x		
14	x		x	x	x	x		x	x
15	x				x	x		x	x
17	x	x			x	x		x	x
19			x	x	x	x	x	x	x
24	x	x	x		x	x		x	x
33	x		x		x	x		x	x
38	x	x			x	x		x	x
77	x	x			x	x		x	x
79				x	x	x	x	x	
88			x	x	x	x		x	x
89	x				x	x		x	x
91	x	x			x	x		x	x
93	x				x	x		x	
97	x	x			x	x		x	x
98	x	x			x	x		x	x

Detailed description of tip styles on the following pages.

Tip Styles Overview

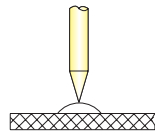

Tip Style 01 (self-cleaning 30° needle tip)
Commonly used, moderately aggressive tip for test pads.

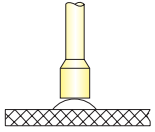

Tip Style 02 (flat)
Very passive tip, for contacting clean test points such as test pads which should not be punctured, as well as connector and plug-in card terminals.

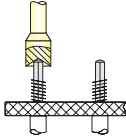

Tip Style 03 (inverse cone)
Commonly used tip for contacting connector pins and wire-wrap posts.

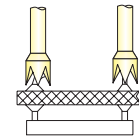

Tip Style 04 (standard 4-point crown)
One of the most commonly used tips for contacting component pins. Not recommended for unwashed PC boards, as contamination and clogging of solder-resin in the throat of the crown can occur.

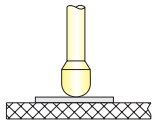

Tip Style 05 (bullet-nosed)
Most popular passive tip style for contacting clean test points such as test pads and even PCB tracks.

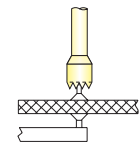

Tip Style 06 (serrated)
Universal tip style for contacting practically all types of pins including connectors, wire-wrap posts, component pins, and so on.

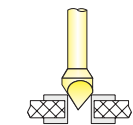

Tip Style 07 (90° 3-edged chisel)
Most common tip style for contacting both plated open vias and test pads, and is increasingly used instead tip style 01. Also used as interface probe tip in conjunction with an INGUN contact terminal (shown on page 70) for the INGUN VIN test fixtures.

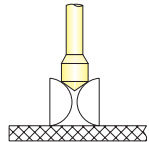

Tip Style 08 (self-cleaning 90° conical)
Used for contacting plated open vias, especially when damage to the contacting area must be avoided. Also suitable for contacting mullet-point and plug-in connectors together with low spring-forces.

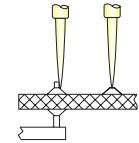

Tip Style 09 (self-cleaning flexi-needle)
Universal tip style for contacting practically all types of test points, except for plated open vias. Offers a high level of stability combined with flexibility. Often chosen for contaminated, unwashed PC boards.

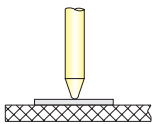

Tip Style 13 (30° rounded tip)
Rather passive tip, commonly used for test pads which must not be punctured. Also suitable for contacting PCB tracks.

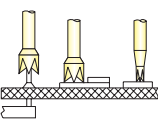

Tip Style 14 (self-cleaning 4-point crown)
Most commonly used for contacting component pins, the modified 04 crown self-cleaning design prevents clogging of solder-resin in the throat of the crown.

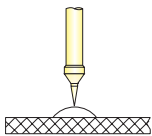

Tip Style 15 (22° self-cleaning high-carbon tip - pressed in)
Extremely aggressive tip which offers a high degree of contact stability while providing exceptional resistance to wear.

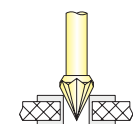

Tip Style 17 (self-cleaning hexagonal)
The six knife-shaped edges centre the tip when contacting plated open vias. Design features of this tip are similar to tip style 07, but it is much more aggressive.

(self-cleaning slotted inverse cone) **Tip Style 19**
 With this modified design of the tip style 03 an aggressive contacting contour in the centre is created by applying cross grooves. Subsequently, a maximum of contacting reliability is achieved when contacting component pins and wire-wrap posts.



(self-cleaning 6-point crown with higher middle point) **Tip Style 24**
 Universally used for practically all test points.

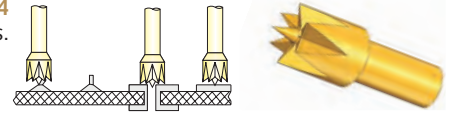

(self-cleaning 3-point crown) **Tip Style 33**
 A modified version of the 4-point self-cleaning crown (tip style 14), manufactured with ground flanks, which creates a more aggressive tip. Can be used both for component pins as well as test pads.



(self-cleaning 150° dagger) **Tip Style 38**
 Comparable with tip styles 97 and 98, however with even flatter tip angle, for contacting open vias and pads.



(3-edged dagger) **Tip Style 77**
 Universally used for plated open vias. Similar characteristics as tip style 91 (dagger), however with three contacting edges instead of two. More stable tip, but therefore less aggressive.



(self-cleaning hexagonal flat spade) **Tip Style 79**
 Multiblade tip style with self cleaning function.



(self-cleaning 8-point crown) **Tip Style 88**
 Self-cleaning crown with centring feature. Suitable for contaminated component pins.

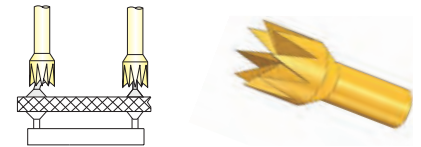

(self-cleaning 3-point crown) **Tip Style 89**
 Recommended for unwashed PC boards. The unique shape of the steel tips ensures that any contaminating particles migrate away from the contacting zone around the points.



(self-cleaning dagger) **Tip Style 91**
 Universally used and by far the most popular tip style. Very aggressive thus suitable not only for plated open vias but also test pads.



(3 x 22° tri-needle, pressed-in steel points) **Tip Style 93**
 The three very aggressive HSS tips make this tip ideal for contacting unwashed PC boards and other challenging test demands.



(self-cleaning 90° 4-edged dagger) **Tip Style 97**
 A modified version of the standard dagger (tip style 91), also for universal use. Designed for plated open vias which are closed with sealing lacquer.



(self-cleaning 90° hexagonal dagger) **Tip Style 98**
 Comparable with tip style 97, also used for contacting open vias, which are closed with sealing lacquer.



(serrated, with insulated outer \varnothing) **Tip Style 006**
 Standard serrated tip with higher-set outer nylon ring, designed for component presence check. The designation "0" denotes nylon material, the designation 06 denotes the inner tip style (example: 006 230 A).



Functional Principles

Test Probes and Receptacles

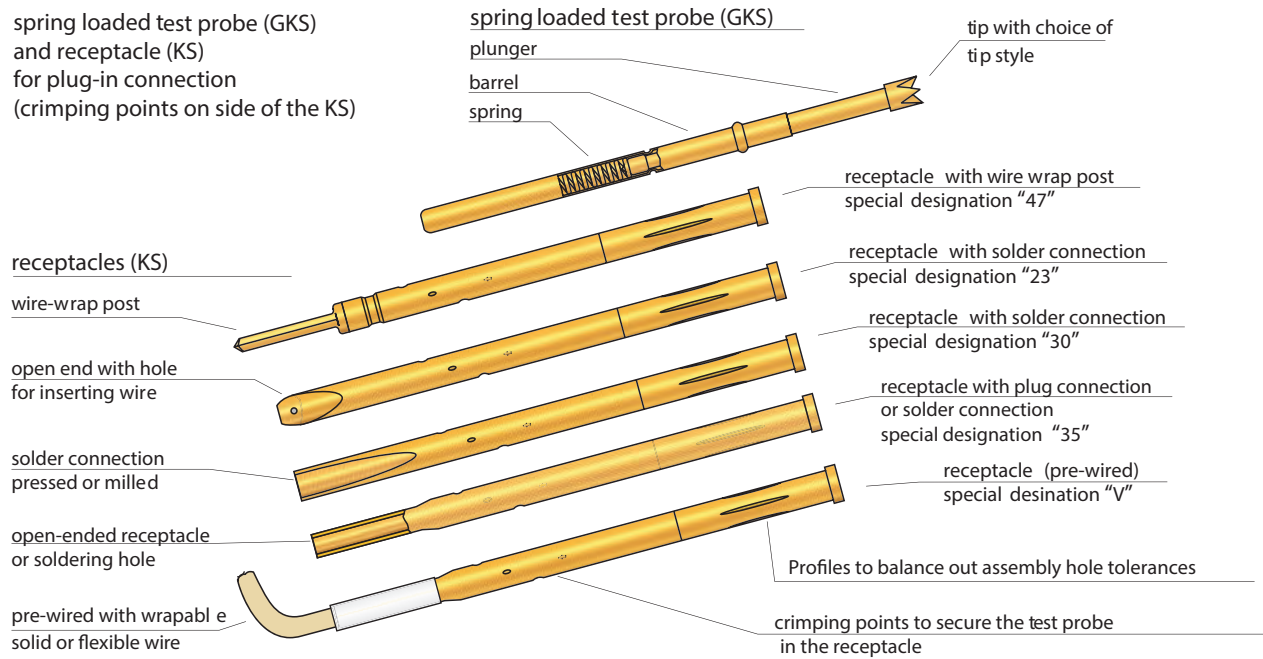

Spring-loaded test probes (GKS) normally consist of three individual components. These components must be manufactured with the level of precision the micro-electronics industry demands.

The plunger features the contacting zone and is available with a wide variety of tip styles. It must provide the smallest possible contact resistance between the test probe and test point to ensure that measurement results are not distorted. The most common plunger materials are steel and BeCu - both of which are hardened; brass is also used for passive tip styles.

The spring provides the contact pressure required for several hundred thousand working strokes (test cycles). The specified spring forces are achieved with the recommended working stroke, and are subject to a tolerance range of 10–15%; this being due to the parameter restrictions when designing and manufacturing springs with such small dimensions. Common spring force measuring gauges can be used for easy measurement of spring forces.

The barrel accommodates the plunger and the spring. The actual measurement signal flows via the barrel to the receptacle. To improve the smooth movement, after gold-plating the barrel is treated with a very thin organic protective layer.

The receptacle (KS) enables easy exchange of test probes during maintenance and servicing of the test fixture. The exchange can be carried out quickly, and without the need for any wiring work. To enable this, crimp points are applied to the side of the receptacle. Note: the crimp points only function properly when the receptacle has been inserted in the assembly hole. This means that test probes can not be mounting in receptacles which are not installed in the probe plate.

Recommended working stroke and maximum stroke

When choosing a test probe for a particular application, the installation height, the choice of tip-style, and the required stroke of the test probe are decisive factors.

In the home position, the test probe plunger is not activated, yet still has a certain pre-load; the beading then acts as a stop to prevent the plunger coming out of the barrel. The rated spring force is reached when the plunger is activated to the working stroke position. Depending on the series, this lies between 66% and 80% of the maximum stroke.

The following example shows the spring force/stroke movement for the various spring forces offered in the series GKS-100:

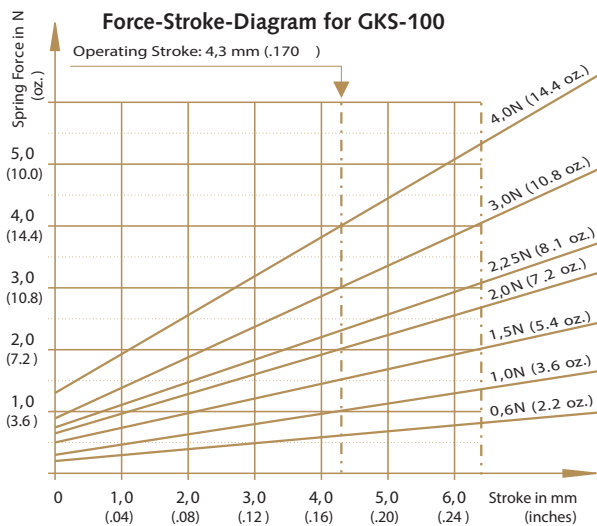

When customising a test fixture or any other type of test equipment, it is important that the recommended working stroke is observed. When the maximum stroke is exceeded, there is the danger of the PC board/UUT or the test equipment (i.e. test fixture, test probes) being damaged or destroyed.

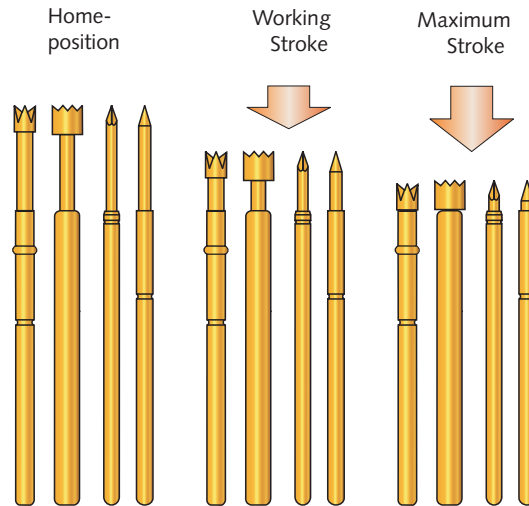

Dependent on whether test pads or component pins are to be contacted, the test probe's working stroke differs. If necessary, INGUN recommend balancing out the various installation heights. Practically all series offer this possibility, either with the choice of different collar heights (of both the test probes as well as the receptacles) or with the choice of longer plungers (i.e. L versions for series GKS-050, 075 and 100).

Collar height and installation height

The installation height is the distance between the tip of the plunger of the non-activated test probe and the surface of the probe plate. To regulate the installation height, the test probes are normally available with various different collar heights. In addition, spacers which offer further installation height flexibility are available for some series. Test probes with the end designation "00" have no collar on the barrel. The installation height of such test probes is determined by the receptacle.

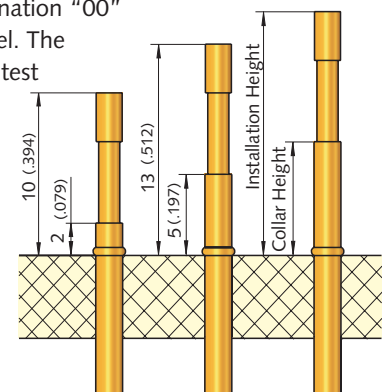

Design and Instructions for Use

INGUN receptacles

A unique feature of new generation INGUN receptacles is the so-called *INGUN crimp profile*. This is a lengthwise crimp (usually three or four points) which is positioned directly below the collar or press ring of the receptacle.

The profile performs the following functions:

- Equalises differences in drilled hole diameter
- Results in steady insertion force of the receptacle in the assembly hole
- Ensures self-alignment of the receptacle and prevents slanting
- Guides and centres the test probe
- Reduces the influence of the assembly hole on the receptacle's retention force.

Normally, the *INGUN crimp profile* is combined with the *INGUN spiral crimp*. This is a 4-point crimp which is applied to the lower end of the receptacle in a 360° spiral pattern.

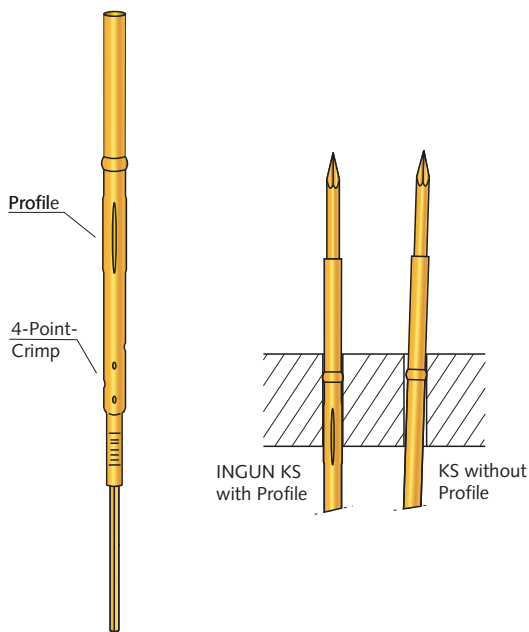

This type of securing crimp ensures:

- Low, steady insertion forces of the test probe
- Steady extraction forces of the test probe
- High flexibility and elasticity of the securing crimp points increases the number of test probe insertion cycles possible.

These excellent insertion and retention conditions arise from the fact that the various securing levels are gradually reached and the crimp points are only slightly malleably deformed. Subsequently, the final retention force of the test probe is only achieved when the last crimp point has been reached.

To ensure the resilience of the crimp, the crimp points must not be soldered or coated with plastic.

3D-CAD models of test probes now online

On our homepage www.ingun.com you can download our CAD data of the test probes as 3D Models in STEP format, which can be opened using any CAD programme. This service offers you the possibility to implement our models in your design work.

The 3D-CAD models can be found in the **Downloads** section of the website.

Wobble and minimum test point size

Due to the necessary play between the plunger and the barrel of a test probe, the tip can be deflected out of the ideal (i.e. vertical) position. This deflection, the so-called "wobble", was measured on INGUN test probes using a state-of-the-art optical measurement device. This machine can, upon request, also be used to verify customised test fixtures. To define the minimum test point size, the various tolerances of the test fixture were also taken into consideration.

It can generally be said that there is no direct correlation between the wobble and the contacting accuracy of a test probe. However, the position of the probe tip at the time of actual contacting is especially important. For the subsequent stroke it is even often an advantage when the wobble is higher, because this then helps to reduce the wear when the plunger is pressed down into the barrel. Furthermore, the likelihood of the test probe bending is reduced, thus prolonging the life-expectancy.

The following diagram shows the deflection of the plunger from the ideal position (i.e. the centre of the assembly hole) of various test probes. The experimental set-up used a standard INGUN probe plate, and the test probes were inserted into receptacles. The row of experimental tests was carried out a number of times. Between each measurement the test probes were activated a few times.

The result of the investigation offers no information about other factors, which must also be taken into consideration, i.e. the tolerances of the PC board and of the test fixture assembly as well as the uncertainties and errors, which can occur during insertion and removal of receptacles and test probes. Therefore, INGUN recommends using a guide plate (especially in the case of challenging applications, i.e. test point size < 0,8 mm) which guide the plunger tips. The majority of the tolerances can then be ignored.

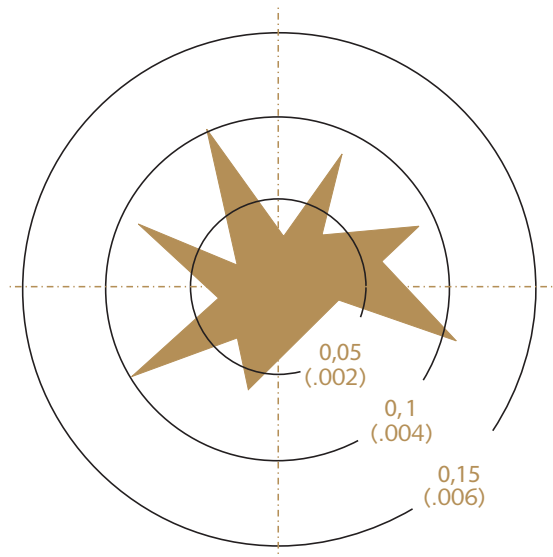

[Measurements in mm (inches)]

Design and Instructions for Use

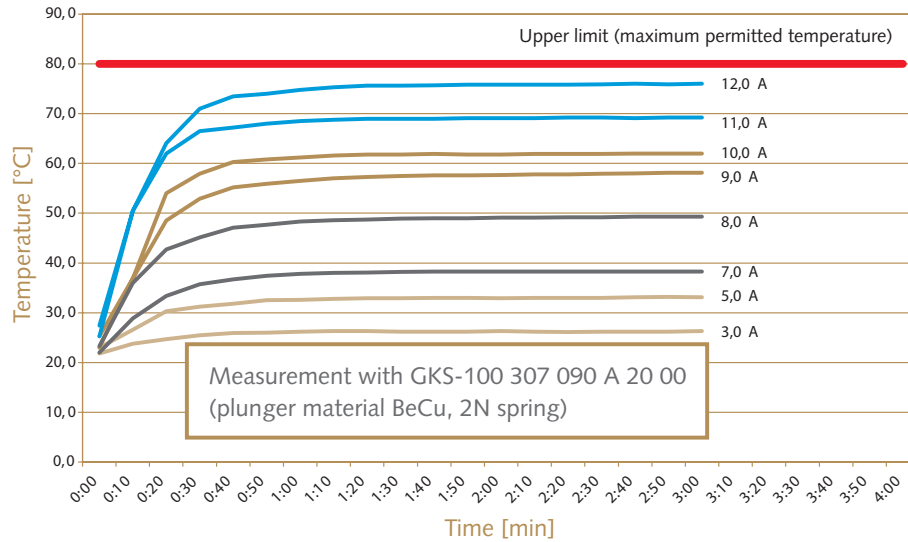

The following diagram shows the evaluation of a test probe of the series GKS-100 with a BeCu plunger and 2,0 N spring force.

Current loading

The transferable permanent current of test probes depends on the size of the components, the spring force and the plunger material used. In the case of the plunger material, the following is applicable: BeCu and brass plungers transfer higher currents than steel plungers. The permitted rated currents are printed on each individual data sheet. These values are valid at room temperature and for direct current from the stated **standard** spring force at working stroke. In the case of alternating currents, the value must be reduced by the factor $\frac{1}{\sqrt{2}}$.

To avoid damage to the test probes, such as component contact under load (attached current/voltage) is not allowed.

The maximum permitted current loading (see "Electrical data" of each product) was derived for each series in extensive load tests. The test set-up called for the various test probe series and spring forces to be loaded with a certain current, during which the temperature change of the test probe was measured. The increase of the current was applied in increments of 1 - 2 Amps, but only as long as no temperature increase was registered.

Drilling tolerances

When machining the assembly holes in the probe plate (KTP) it is necessary to differ between the diameter of the drilled hole and the diameter of the actual drill. The sizes stated in the catalogue refer to the diameter of the drilled hole. This size can be measured with a standard plug gauge. Depending on the material and the thickness of the probe-plate, the diameter of the drill should be 0.01–0.03 mm larger. At the same time, other parameters such as drill speed and feed, and so on, also play an important role. Note: it is vital to carry out drilling tests before the final drilling of the probe plate.

The materials FR4/G10 (fibreglass enforced synthetic material) and CEM1/Trolitax (hard-paper impregnated with resin) have proven to be especially suitable as probe-plate materials. Especially in the case of small assembly hole diameters, there is an acute danger of the drilled holes slanting, which leads to both receptacles and test probes also being slanted when inserted, and subsequently impairs the contacting accuracy. In this case, INGUN recommends that the assembly holes in probe plates thicker than > 10 mm are counter-bored from the underside. Furthermore, drilling the holes in stages is also advisable.

Life expectancy of INGUN test probes

To determine the life expectancy of test probes, INGUN continuously carries out lifecycle tests under laboratory conditions using computer-controlled fully automatic lifecycle test stations.

Here, the behaviour of important parameters such as contact resistance or the spring force during the life of a test probe can be observed and defined. The resulting knowledge is taken into consideration in the development phase, guaranteeing state-of-the-art quality standards.

The life expectancy of test probes is a function of various parameters such as spring force, operation below or above recommended working stroke, axial loading, current loading, as well as external influences such as contamination and temperature.

INGUN has avoided including any diagrams and tables of tests carried out under laboratory conditions, because such results would only give the user a false impression. This being because the previously stated influences are non-calculable factors, which can have a decisive influence on the life-expectancy of a test probe. Under laboratory conditions it is possible for some test probes series to achieve well over 1 million cycles, but the actual period of usage could well be much less because, for example, the strong general wear of the test probe leads especially to wear of the contacting zone—resulting in a drastic increase of the contact resistance values.

Application temperature range

INGUN test probes can be used without any problems between -40°C and +80°C. For lower and higher temperature ranges there are many solutions available see “Application Temperature Range” by the various probe series.

These test probes are normally recognisable with the special designation “C” (-100°C to +200°C). Certain high-alloyed (stainless steel) spring steel types are used, which however have the disadvantage that the transition resistance is up to factor 10 higher as by standard test probes. Apart from this, the stability of the resistance is affected (i.e. fluctuations are possible).

In the case of these solutions there is also the danger that greater temperature fluctuations, as well as operation in temperatures other than normal can lead to premature breakdown or a reduction of the life-expectancy of the test probe.

Note:

Additional warming occurs (e.g., as a result of high currents) when test probes are used at high ambient temperatures, for example in a climatic chamber.

This may cause the temperature to exceed the recommended operating temperature range and result in damage to the test device or test probes.

Materials and Environmental

Base materials

The choice of the base materials is dependent on the performance demanded of each individual component.

Brass is sometimes used for passive tip styles and for machined barrels. The high percentage of copper makes it an ideal electrical conductor. Brass, however, is too soft for aggressive tip styles.

Steel is used for practically all aggressive tip styles, and provides a high degree of hardness and sharpness of the points and the flanks. This ensures good durability and reliable contacting.

BeCu (Beryllium Copper) provides a good combination and compromise between brass and steel: The high percentage of copper makes it an ideal electrical conductor and the small percentage of Beryllium allows the base material to be hardened (up to 435 HV). This ensures good durability and optimises the aggressiveness of the plunger tip.

Nickel silver (NiAg) and bronze are mainly used for receptacles and the barrels of the test probes. These materials have a high tensile strength, which is ideal for the long-term life of test probes. Furthermore, these materials provide elasticity to the crimps on the receptacles.

Spring steel of the highest possible quality is used for the manufacturing of the springs. For high and low temperature ranges, certain high-alloyed spring steels (i.e. stainless steel) are used.

Plating materials

Hard gold, chemical nickel, and rhodium are used to plate test probes, depending on which functional features are required. **Hard gold** provides the best chemical resistance, has a hardness range of 150 - 200 HV, and is especially good against oxidation.

Rhodium is extremely resistant to abrasion, has a hardness range of 600 - 1000 HV, but it is very brittle. Therefore, this plating material is not suitable for aggressive tip styles in conjunction with high spring forces. Rhodium is used when plunger tips are required to be especially durable.

Chemical nickel offers very good chemical resistance, and has a hardness range of 400 - 600 HV, which prevents contamination build up on points and edges (the so-called "dog-bone" effect). Thus, it makes an excellent durable layer for plungers and is ideal for aggressive tip styles.

Aurun is a gold-alloy plating material which was developed especially for test probes, has very good chemical resistance and a hardness range of 300 - 350 HV. It is used for aggressive tip styles to test unwashed PC boards.

All plating materials guarantee the best contacting reliability due to their very low, specific resistance values.

EG Environmental Legislation

Numerous European Environmental Legislation Acts aim to ensure a high level of protection of human health and the environment. This legislation is always observed as part of the business decisions and actions taken by INGUN Prüfmittelbau GmbH.

INGUN has prepared official statements for the most important of the current European Environmental Legislation Acts, up-to-date versions of which are available on our homepage www.ingun.com.

INGUN Environment Compliance Statement	REACH EU ordinance 1907/2006	RoHS EU directive 2011/65/EU	ACPEIP "China-RoHS"
Conflict Minerals Dodd-Frank Act	BIOCIDE EU/528/2012	CLP EG/1272/2008	DMF EU directive 2009/251/EC
PFOS EU directive 2006/122/EC	UL- certification UL 94	Radioactively contaminated stainless steel	PAK ZEK 01.2-08

FAQ

Frequently Asked Questions

<p><i>What is a grid?</i></p>	<p>The term grid describes the distance between two test points on a PCB/DUT, the distance between two component pins or connectors. Based on the test probe, the distance is defined as the middle of one mounting hole to the middle of the next mounting hole on the probe plate. There are internationally recognised grid distances which manufacturers of PCBs and connectors observe. Because the definition is based on imperial units rather than metric units, the grid size is given in inches. Because the grid size are sometimes very small, the grid dimension 1/1000 inch is used. 1/1000 inch is also denoted as Mil.</p> <p>The most common grid dimensions are: 40 Mil = 1.0 mm 50 Mil = 1.27 mm 75 Mil = 1.91 mm 100 Mil = 2.54 mm</p>
<p><i>Does a high spring force ensure reliable contact?</i></p>	<p>No. As a rule of thumb, the spring force should simultaneously be as low as possible in order to minimise the stress placed on the device under test (DUT), but also as high as necessary to guarantee a reliable electrical contact. Furthermore, other criteria, such as tip style, test environment, etc. must be taken into consideration in order to select the correct spring force.</p>
<p><i>What is the difference between receptacles with press ring and receptacles with a collar?</i></p>	<p>Turned receptacles with a defined collar or a receptacle with a press ring (end designation "G") are used to regulate the installation height of test probes. Turned receptacles are pressed into the assembly borehole up to the collar, which acts as a stopper to achieve a defined installation height. The press ring receptacles can also be installed using the press ring as a stopper, but with the press ring countersunk in the borehole making the installation height adjustable. The main difference between receptacles with and without a press ring is the production process. Barrels with press rings are deep drawn and have a compressed collar, which has elastic properties. Receptacles without press rings are produced using traditional turning methods to hollow out solid material, which means the collar is rigid and cannot be countersunk in assembly boreholes.</p>
<p><i>When should threaded test probes be used?</i></p>	<p>Threaded test probe have the special designation "M" and are screwed into the receptacle rather than pressed in. These type of receptacles are used in particularly challenging test conditions, such as installation in a test set-up subject to vibrations, or top-down installation, to ensure the test probe remains securely in the receptacle.</p>
<p><i>Why do some receptacles have a knurl and others do not?</i></p>	<p>Knurled receptacles are used especially for assembly boreholes with higher than specified tolerances or when non-rotating test probes are used, as they minimise the turning or loosening of the receptacle in an assembly borehole with increased tolerances. When the tolerances given are adhered to, a receptacle without a knurl can be used without any difficulty.</p>

ICT/FCT Test Probes

In-circuit and Function Test

During **in-circuit tests (ICT)** all components on the PCB are measured. In doing so, defective components are detected and can be replaced accordingly.

Function tests (FCT) check the entire intended function of a PCB. According to the intended area of use, the environment is replicated and the electrical performance of the PCB is checked.

In order to optimally fulfill the contacting requirements, various test probes are available. These differ in terms of installation height, grid size (possible distance between probes), tip style, and type of connection – see following illustration. The electrical connection is achieved either with a solder cup or wire-wrap, with or without cable (wireless).

Contacting loaded PCBs

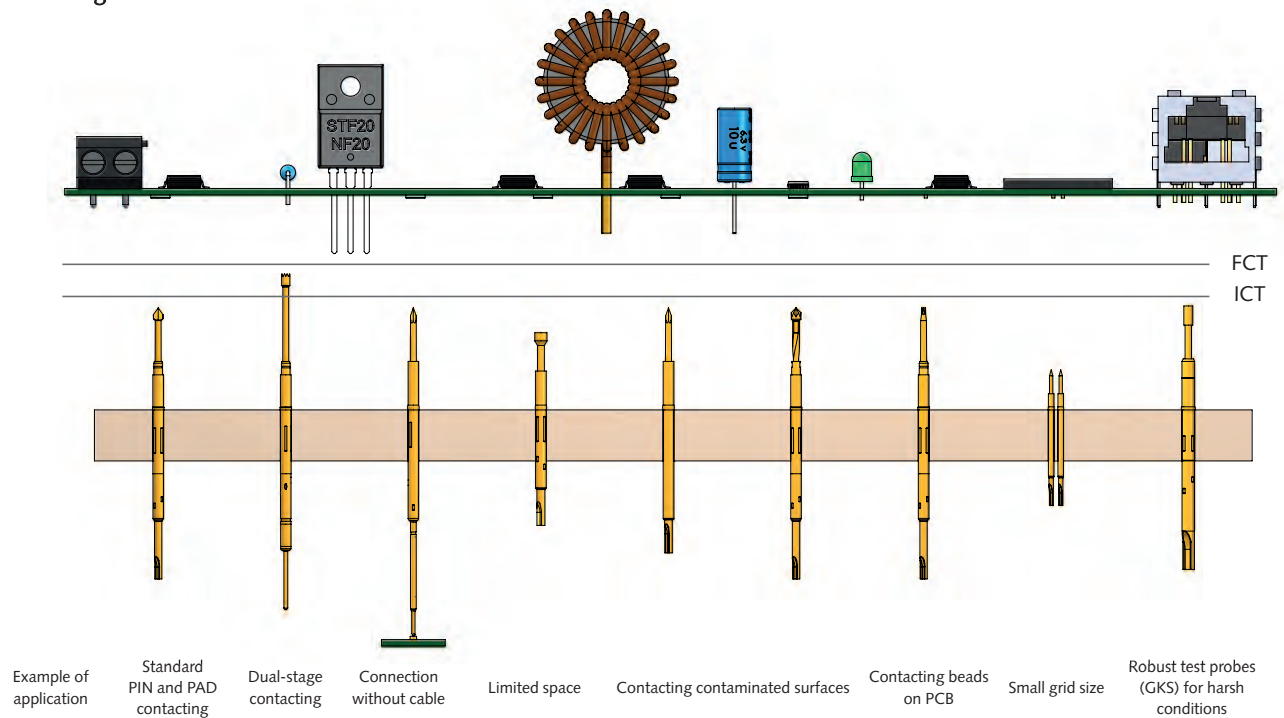

Grid size / series	International standard test probes				INGUN E-TYPE®	Rotating Probe	Bead Probe	Fine pitch	Metric standard
	Standard stroke	Long stroke	Wireless	Short test probes					
≥ 0.63 mm (≥ 25 Mil)	-	-	-	-	-	-	-	GKS-038 GKS-061	-
≥ 1.00 mm (≥ 40 Mil)	GKS-040	-	KS-040 WL	-	-	-	-	GKS-080 GKS-081	-
≥ 1.27 mm (≥ 50 Mil)	GKS-050	GKS-015	KS-050 WL	NEW GKS-550	E-050	DKS-050	GKS-050	GKS-069 GKS-079/181	-
≥ 1.91 mm (≥ 75 Mil)	GKS-075	GKS-035	KS-075 WL	GKS-001	E-075	DKS-075	GKS-075	-	-
≥ 2.54 mm (≥ 100 Mil)	GKS-100	GKS-135	KS-100 WL	GKS-002	E-100 E-422	DKS-100	GKS-100	-	GKS-112 GKS-912
3.0 bis 5.0 mm (125 to 200 Mil)	-	-	-	GKS-003 GKS-004/005	-	-	-	-	GKS-113/913 GKS-103/503 GKS-854
Page(s)	24 - 29	30 - 32	33	34 - 40	42 - 43	44 - 46	48	52 - 57	61 - 72

Depending on the PCB to be contacted, and the ambient conditions, INGUN offers a variety of test probes:

International standard spring-loaded test probes (GKS) (inch)

Available in two different versions: Standard working stroke (4.3 mm) and longer working stroke (9.3 mm) for dual- stage test fixtures to combine ICT and FCT.

Wireless receptacles enable the wireless connection of test probes using a transfer PCB.

Short / robust test probes stand out due to their robust, compact design.

INGUN E-TYPE® test probes have a higher preload in comparison to standard test probes. This initial higher spring force guarantees a secure contact at the same final load (the spring force is equal to that of the comparable standard test probe at working stroke).

Rotating test probes can provide a reliable alternative if contacting problems occur. A rotating movement during the stroke process scratches the surface to be contacted, thus insulating layers are securely penetrated.

Bead test probes are used to contact beads on PCBs. A variety of tip styles are available depending on the beads.

Fine pitch test probes are used to contact very small test points in small grids. These are sometimes mounted without receptacles.

Metric test probes (metric standard)

In addition to the classic ICT/FCT test probes without collars, the metric standard test probes stand out due to their stability and robustness and all feature a pronounced collar.

ICT/FCT Test Probes

Standard Stroke	24 - 29
Long Stroke	30 - 32
Wireless Receptacles	33
Short/Robust Test Probes (GKS)	34 - 40
INGUN E-TYPE®	42 - 43
Rotating Test Probes (DKS)	44 - 46
Bead Probes	48
Flying Probes	49
Fine Pitch	52 - 57
Metric Standard	61 - 72

Note:

See next page for overview and comparison table.

ICT- FCT

Overview and Comparison of Test Probes

Test probe version	Series	Grid size (≥ mm)	Working stroke (mm)	Max. stroke (mm)	Current rating (A)	Spring forces (N)		Installation heights with receptacles (mm) v = variable			Shortest probe (mm)	Page
						min	max	min	max	v		
Standard stroke	GKS-040	1	4.3	6.35	2	0.8	-	16	18	v	35.9	24
	GKS-050	1.27	4.3	6.35	2-3	1	2	16	18	v	43.2	25
	GKS-075	1.91	4.3	6.35	3-4	0.6	2.8	10.5	23	v	33.1	26
	GKS-100	2.54	4.3	6.35	5-8	0.6	4	10.5	25.5	v	33.4	28
Long stroke	GKS-015	1.27	8	10	2-3	1	1.5	21.3	23.3	v	48.5	30
	GKS-035	1.91	8	10	3-4	1.2	-	14.2	23.7	v	36.8	31
	GKS-135	2.54	9.3	11.5	5-8	1.5	3	15.8	21.3	v	38.7	32
Wireless receptacles	KS-040 WL	1	2.5	4	2-3	1	-	-	16	v	43.4	33
	KS-550 WL	1.27	2.5	4	2-3	1	-	-	16	v	43.1	33
	KS-075 WL	1.91	2.5	4	2-3	1	-	-	16	v	43.1	33
	KS-100 WL	2.54	2.5	4	2-3	1	-	-	16	v	43.1	33
Short / robust test probes (GKS)	NEW GKS-550	1.27	4.3	6.35	2-3	1	1.5	-	16	v	34.6	34
	GKS-101	1.91	4	5.3	3-4	0.5	1.5	12.5	14	-	27.3	35
	GKS-001	1.91	2.4	3	3-4	0.6	1.5	-	8.5	v	17	36
	GKS-002	2.54	2.7	4.1	5-8	1	2.8	-	12.1	v	24.6	37
	GKS-003	3.18	4.4	6.35	5-8	1.2	3	-	16	v	33.1	38
	GKS-004	4.75	4.4	6.35	6-8	1.5	3	-	16.5	v	33.6	39
INGUN E-TYPE®	E-050	1.27	4.3	6.35	2-3	2	-	16	18	v	43.2	42
	E-075	1.91	4.3	6.35	3-4	2	2.8	10.5	20	v	33.1	42
	E-100	2.54	4.3	6.35	5-8	2	3	10.5	25.5	v	33.4	43
	E-422	2.54	6.4	8	5-8	2.25	3	16.2	24	v	38.4	43
Rotating test probe (DKS)	DKS-050	1.27	4.3	6.35	2-3	1.5	2	16	18	v	43.2	44
	DKS-075	1.91	4.3	6.35	3-4	1	2	10.5	20	v	33.1	44
	DKS-100	2.54	4.3	6.35	5-8	1	3	10.5	25.5	v	33.4	44
	GKS-725	2.54	4	5	3-4	1.5	-	13.0	16.0	-	30	45
	GKS-713	4.5	4	5	5-8	1.5	5	13.2	18.2	-	40	46
Bead probes	GKS-050	1.27	4.3	6.35	2-3	1	2	16	18	v	43.2	48
	GKS-075	1.91	4.3	6.35	3-4	0.6	2.8	10.5	23	v	33.1	48
	GKS-100	2.54	4.3	6.35	5-8	0.6	4	10.5	25.5	v	33.4	48
	GKS-135	2.54	9.3	11.5	5-8	1.5	3	15.8	21.3	v	38.7	48
	GKS-550	1.27	4.3	6.35	2-3	1	1.5	-	16	v	34.6	48
Flying probe	GKS-112 MD	2.54	4	5.3/8	5-8	0.6	3	14.7	21.6	-	40	49
Fine pitch	GKS-038	0.635	2	2.5	1	0.4	-	4	-	-	24	52
	GKS-061	0.8	2.5	3.5	2	0.6	-	5.5	-	-	36.2	52
	GKS-080	1	3	3.8	3	0.8	-	10.5	-	-	19.3	53
	GKS-081	1	5.5	7.5	3	0.8	-	10.5	16	-	34.6	54
	GKS-069	1.27	2.2	2.8	3	0.7	1	6.3	6.7	v	16.5	55
	GKS-079	1.27	1	1.2	3	1.3	-	3.2	-	-	14.5	56
	GKS-181	1.27	5.5	7.5	2-3	0.8	1.5	10.5	16	-	34.8	57
Metric standard	GKS-112	2.54	4	5.3/8	5-8	0.6	5	26.3	32.3	v	40.3	61
	GKS-912	2.54	4	5	5-8	0.6	5	10.2	26	v	32	62
	GKS-422	2.54	6.4	8	5-8	0.8	5	16.2	24	v	38.4	63
	GKS-412	2.54	8	9.8	5-8	0.6	5	15	30.8	v	37.8	64
	GKS-204	2.54	8	10	5-8	0.8	3	16.2	23.2	-	47.9	65
	GKS-102	2.54	4.8	6.5	5-8	1.5	5	12.75	13.75	-	42.5	66
	GKS-502	2.54	5.6	7	5-15	0.8	5	12.2	13.2	-	39.1	67
	GKS-113	4	4	5.3	5-8	0.3	5	10.5	18.5	-	27.3	68
	GKS-913	4	2.8	3.5	5-8	0.8	2.5	7.3	9.0	-	15.1	69
	GKS-103	4	4.8	6	5-8	0.8	5	12.55	-	-	29.3	70
	GKS-503	4	5.6	7	5-15	1.5	5	13.25	-	-	38	71
	GKS-854	5.08	4.4	5.5	10-12	3	5	10.8	-	-	38.5	72

International Standard GKS (GKS without Collar)

Standard stroke test probes have consistently proven to be reliable ICT/FCT test probes.

Depending on the working stroke of the test fixture, or the component or test points to be tested, various installation heights are necessary. These can be achieved by a choice of combinations of test probes and receptacles. Thus, the optimal working stroke with nominal spring force can be achieved.

Test probes come in standard, L (+ 2.0 mm), and E (+ 5.0 mm) versions, as well as receptacles with various collar heights.

Long stroke test probes are used for combined ICT/FCT test in dual-stage test fixtures.

Wireless receptacles are used to transmit signals over a spring-loaded plunger on a transfer PCB. Thus, a cable is not required.

Short / robust test probes stand out due to their robust, compact design. This makes them suitable for harsh ICT/FCT applications with limited space available, as well as in larger grid sizes.

Standard Stroke

GKS-040	24
GKS-050	25
GKS-075	26
GKS-100	28

Long Stroke

GKS-015	30
GKS-035	31
GKS-135	32

Wireless Receptacles

KS-040 WL	33
KS-550 WL	33
KS-075 WL	33
KS-100 WL	33

Short/Robust Test Probes (GKS)

GKS-550 NEW	34
GKS-101	35
GKS-001	36
GKS-002	37
GKS-003	38
GKS-004	39
GKS-005	40

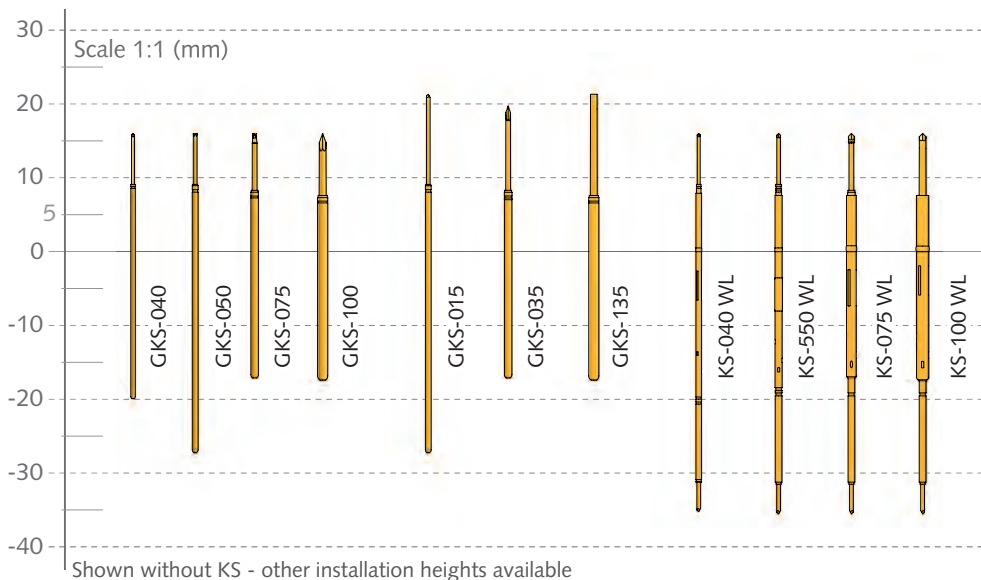

Note:

See page 22 for overview and comparison table.

GKS 040

ICT-/FCT Test Probe

Grid:

≥ 1,00 mm

≥ 40 Mil

Installation height with KS: 16,0 / 18,0 mm (.630 / .709) / variable

Recommended stroke: 4,3 mm (.169)

Mounting and functional dimensions

GKS-040

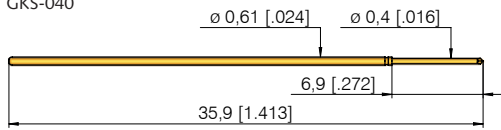

GKS-040 ... LP

(Long version with longer plunger. See "available tip styles".)

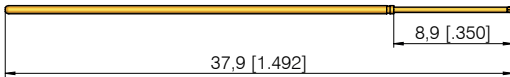

KS-040 E08

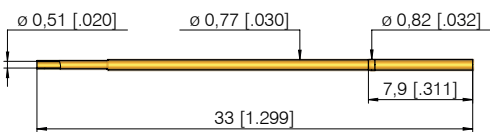

KS-040 E08 V-30



Available tip styles version GKS-040

Material	Tip style	Plating	Further versions	
			∅	∅ (inch)
3 04	∅ 0,40 (.016)	A		
3 05	∅ 0,40 (.016)	A		
2 22 *	∅ 0,32 (.013)	A		
2 38	∅ 0,40 (.016)	A		
2 97	∅ 0,40 (.016)	A		

* conical down to ∅ 0,40 mm

Available tip styles special version GKS-040...LP

Material	Tip style	Plating	Further versions	
			∅	∅ (inch)
2 97	∅ 0,40 (.016)	A		

Total length 37,9 mm (1.492), special designation "LP"

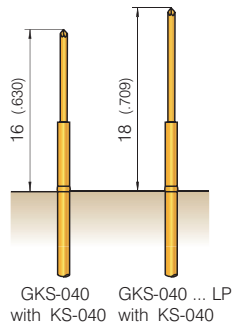

Collar height and installation height

To adjust the installation height, receptacles with a press ring are used. The receptacles can be inserted up to the press ring (i.e. acting as a collar-stop) or with the press ring pressed into the mounting hole.

Mechanical data

Working stroke: 4,3 mm (.169)
Maximum stroke: 6,35 mm (.250)
Spring force at work. stroke: 0,8 N (2.9oz)

Materials

Plunger: Steel or BeCu, gold-plated
Barrel: Bronze, gold-plated
Spring: Steel, gold-plated
Receptacle: Nickel-silver, gold-plated

Note:

Receptacles for wireless test fixtures shown page 33.

Electrical Data

Current rating: 2 A
R_i typical: < 20 mΩ

Operating temperature

Standard: -40° up to +80° C

Note:

The receptacle KS-040 is available pre-wired with 1 m AWG 30 wire (see **ordering example**). Minimal recommended bending radius: 10 mm (.394).

Mounting hole size

in CEM1 und FR4: ∅ 0,79-0,80 mm (.0311-.0315)

Ordering example

Series	Tip material 2 = Steel 3 = BeCu	Tip style	Tip diameter (1/100 mm)	Plating A = Gold	Spring force (dN)	Collar height (mm)	Special designation ("LP")
--------	---------------------------------------	-----------	----------------------------	---------------------	----------------------	-----------------------	-------------------------------

Test probe with total length 35,9 mm (1.413):

G K S 0 4 0 2 9 7 0 4 0 A 0 8 0 0

Test probe with total length 37,9 mm (1.492):

G K S 0 4 0 2 9 7 0 4 0 A 0 8 0 0 LP

Receptacles:

K S - 0 4 0 E 0 8 K S - 0 4 0 E 0 8 V - 3 0

Grid:
 ≥ 1,27 mm
 ≥ 50 Mil

Installation height with KS: 16,0 / 18,0 mm (.630 / .709) / variable
Recommended stroke: 4,3 mm (.169)

Mounting and functional dimensions

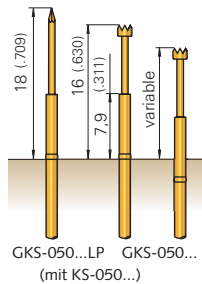
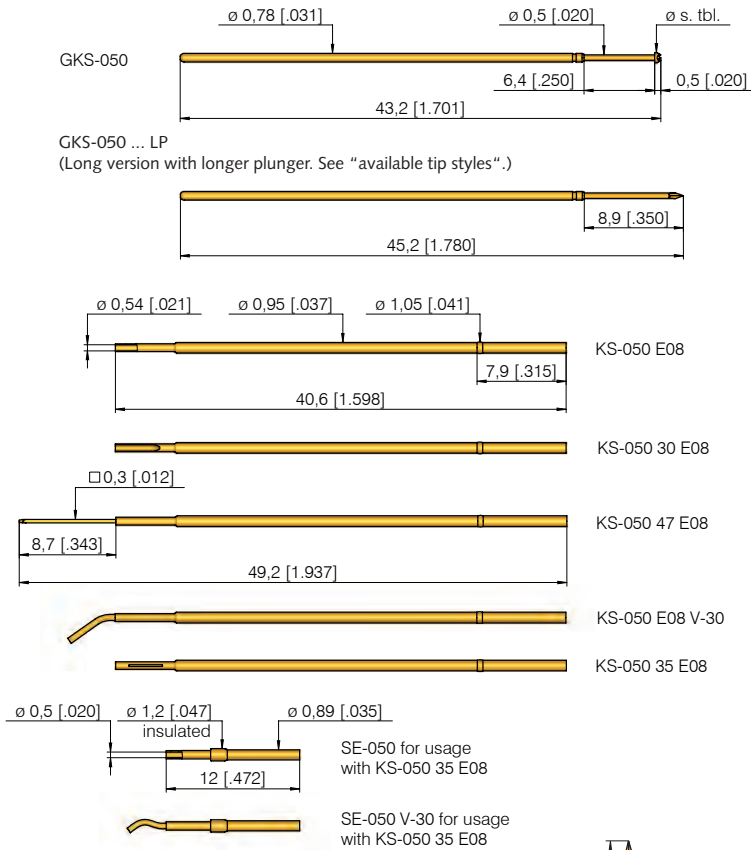

Collar height and installation height

To adjust the installation height, receptacles with a press ring are used. The receptacles can be inserted up to the press ring (i.e. acting as a collar-stop) or with the press ring pressed into the mounting hole.

Mechanical data

Working stroke: 4,3 mm (.169)
Maximum stroke: 6,35 mm (.250)
Spring force at work. stroke: 1,5 N (5.4oz)
Alternative: 1,0 N (3.6oz); 2,0 N (7.2oz)

Electrical Data

Current rating: 2 - 3 A
R_i typical: < 20 mΩ (***) < 100 mΩ

Mounting hole size

in CEM1 and FR4: $\varnothing 0,98 - 1,00$ mm (.0386 -.0394)

Materials

Plunger: BeCu or steel, gold-plated
Barrel: Bronze, gold-plated
Spring: Steel, gold-plated or stainless steel*** (C)
Receptacle: BeCu, gold-plated

Operating temperature

Standard: -40° up to +80° C
*****with special designation "C":** -100° up to +200° C (2,0 N)

Note:

Screw-in versions shown on page 121.

Available tip styles version GKS-050

Material	Tip style	Plating	Further versions	
			\varnothing	\varnothing (inch)
2 01		A	$\varnothing 0,50$ (.020)	
3 02		A	$\varnothing 0,60$ (.024)	
3 03		A	$\varnothing 0,50$ (.020)	0,90 (.035)
3 05		A	$\varnothing 0,50$ (.020)	
3 06		A	$\varnothing 0,90$ (.035)	
3 07		A	$\varnothing 0,50$ (.020)	0,90 (.035)
2 14		A	$\varnothing 0,50$ (.020)	
3 19		A	$\varnothing 0,90$ (.035)	
2 22*		A	$\varnothing 0,40$ (.016)	
2 31		A	$\varnothing 0,50$ (.020)	
2 38		A	$\varnothing 0,50$ (.020)	
2 77		A	$\varnothing 0,50$ (.020)	
2 91		A	$\varnothing 0,50$ (.020)	
2 97		A	$\varnothing 0,50$ (.020)	

* conical down to $\varnothing 0,50$ mm

Available tip styles special version GKS-050...LP

Material	Tip style	Plating	Further versions	
			\varnothing	\varnothing (inch)
2 91		A	$\varnothing 0,50$ (.020)	

Total length 45,2 mm (1.780), special designation "LP"

SE-050 V-30 / KS-050 E08 V-30:

The plug and receptacle are pre-wired with 1 m AWG 30 wire. The connection is soldered. Insulation tubing prevents shorts between the receptacles. Minimal recommended bending radius: 10 mm (.394).

Ordering example

	Series	Tip material 2 = Steel 3 = BeCu	Tip style	Tip diameter (1/100 mm)	Plating A = Gold	Spring force (dN)	Collar height (mm)	Special designation ("C"; "LP")
Test probe with total length 43,2 mm (1.700):	G K S	0 5 0	2 9 1	0 5 0	A	1 0	0 0	
Test probe with total length 45,2 mm (1.780):	G K S	0 5 0	2 9 1	0 5 0	A	1 5	0 0	LP
Receptacles:	KS-050 E08	KS-050 30 E08	KS-050 35 E08	KS-050 E08 V-30				
Plugs:	SE-050	SE-050 V-30						

GKS 075

ICT-/FCT Test Probe

Grid:

≥ 1,91 mm

≥ 75 Mil

Installation height with KS: 10,5 - 23,0 mm (.413 / .906)

Recommended stroke: 4,3 mm (.169)

Mounting and functional dimensions

GKS-075

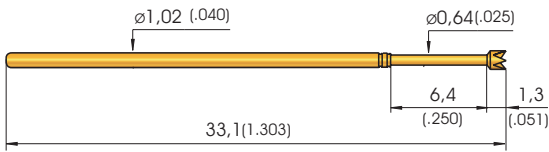

GKS-075 ... LH

(Long version with longer barrel.)

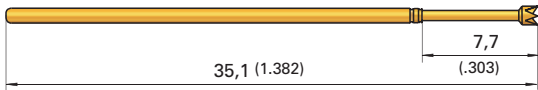

GKS-075 ... LP

(Long version with longer plunger. See "available tip styles".)

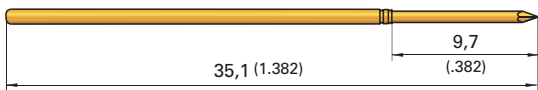

GKS-075 ... E

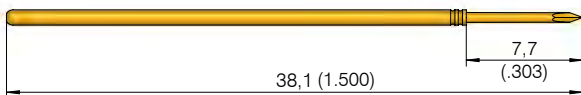

Available tip styles

Material	Tip style	Plating	Further versions	
			∅	∅ (inch)
0 06*		A	∅ 1,30 (.051)	
2 01		A	∅ 0,64 (.025)	
3 02		A	∅ 0,90 (.035)	
3 03		A	∅ 1,20 (.047)	
2 04		A	∅ 1,15 (.045)	
3 05		A	∅ 0,50 (.020)	
3 05		A	∅ 0,64 (.025)	
3 06		A	∅ 1,00 (.039)	1,20 (.047)
2 07		A	∅ 0,64 (.025)	
2 07		A	∅ 1,00 (.039)	1,20 (.047)
2 09		A	∅ 0,64 (.025)	
3 13		A	∅ 0,61 (.024)	
2 14		A	∅ 0,50 (.020)	
2 14		A	∅ 0,64 (.025)	
2 14		A	∅ 0,80 (.031)	1,00 (.039)
2 17		A	∅ 1,20 (.047)	

* tip height; 2,8 mm (.110)
total length 1,5 mm (.059) longer than standard

Mechanical data

Working stroke: 4,3 mm (.169)

Maximum stroke: 6,35 mm (.250)

Spring force at work. stroke: 2,0 N (7,2oz)

Alternative (only for GKS-075/075 L):
0,6 N (2.2oz); 1,0 N (3.6oz);
1,5 N (5.4oz); 2,8 N (10.1oz)

Materials

Plunger: BeCu or steel, gold-plated

Barrel: Nickel-silver or Bronze, gold-plated

Spring: Steel, gold-plated or stainless steel** (C)

Operating temperature

Standard: -40° up to +80° C

****with special designation "C":**

-100° up to +200°C (2,0 N; 2,8 N)

C-versions only available for GKS-075 with total length 33,1 mm (1.303).

Elektrical Data

Current rating: 3 - 4 A

R_j typical: < 20 mΩ (** < 100 mΩ)

INGUN recommend using stroke measurement probes (shown on page 192) to check the working stroke of a test fixture.

Note: Screw-in versions shown on page 122.

Ordering example

	Series	Tip material 0 = Delrin 2 = Steel 3 = BeCu	Tip style	Tip diameter (1/100 mm)	Plating A = Gold	Spring force (dN)	Collar height (mm)	Special designation ("C"; "LH"; "LP"; "E")
Test probe with total length 33,1 mm (1.303):	G K S	0 7 5	2 9 1	0 6 4	A	2 0	0 0	
Test probe with total length 35,1 mm (1.382):	G K S	0 7 5	2 9 1	0 6 4	A	1 5	0 0	LP
Test probe with total length 38,1 mm (1.500):	G K S	0 7 5	2 9 1	0 6 4	A	2 0	0 0	E

Grid:
 ≥ 1,91 mm
 ≥ 75 Mil

Installation height with KS: 10,5 - 23,0 mm (.413 - .906) / variable
Recommended stroke: 4,3 mm (.169)

Mounting and functional dimensions

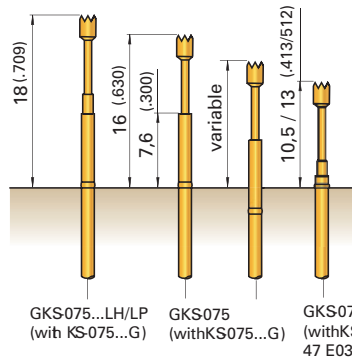
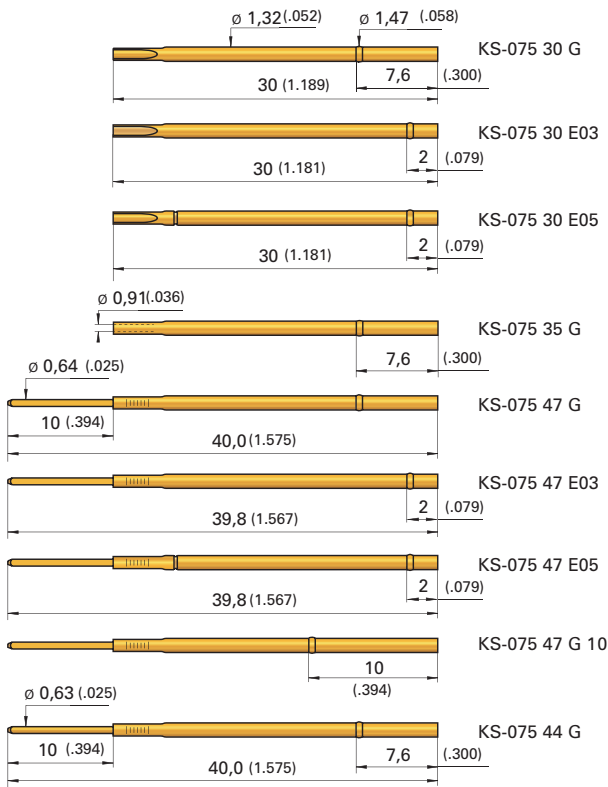

Collar height and installation height

To adjust the installation height, receptacles with a press ring are used. The receptacles can be inserted up to the press ring (i.e. acting as a collar-stop) or with the press ring being pressed into the mounting hole. (See "Mounting hole size" and "Application example" on this page).

Designation	GKS-075	GKS-075 ... LH/LP	GKS-075 ... E
KS-075 ... E03	10,5 mm (.413) / var.	12,5 mm (.492) / var.	15,5 mm (.610)
KS-075 ... E05	13,0 mm (.512) / var.	15,0 mm (.591) / var.	18,0 mm (.709)
KS-075 ... G	16,0 mm (.630) / var.	18,0 mm (.709) / var.	21,0 mm (.827)
KS-075 ... G 10	18,0 mm (.709) / var.	20,0 mm (.787) / var.	23,0 mm (.906)

Mounting hole size

Press-ring pressed in mounting hole:
 $\phi 1,39-1,40$ mm (.0547-.0551)

Pressing as collar-stop:
in CEM1: $\phi 1,30-1,32$ mm (.0512-.0520)
in FR4: $\phi 1,31-1,33$ mm (.0516-.0524)

Materials

Receptacle: Nickel-silver, gold-plated

		Available tip styles		
Material	Tip style	Plating	Further versions	
			ϕ	ϕ (inch)
3 19		A	1,50	(.069)
2 24 ***		A		
2 25		A	1,30	(.051)
2 31		A		
2 38		A		
3 55	 $\phi 1,2$, $\phi 1$, $\phi 0,50$ (.020), $\phi 0,64$ (.025), $\phi 0,80$ (.031), $\phi 1,20$ (.047), $\phi 1,30$ (.051), $\phi 1,32$ (.052), $\phi 1,47$ (.058), $\phi 1,50$ (.059), $\phi 1,52$ (.059), $\phi 1,57$ (.062), $\phi 1,60$ (.063), $\phi 1,65$ (.065), $\phi 1,70$ (.067), $\phi 1,75$ (.069), $\phi 1,80$ (.071), $\phi 1,85$ (.073), $\phi 1,90$ (.075), $\phi 1,95$ (.077), $\phi 2,00$ (.079), $\phi 2,05$ (.081), $\phi 2,10$ (.083), $\phi 2,15$ (.085), $\phi 2,20$ (.087), $\phi 2,25$ (.089), $\phi 2,30$ (.091), $\phi 2,35$ (.093), $\phi 2,40$ (.095), $\phi 2,45$ (.097), $\phi 2,50$ (.099), $\phi 2,55$ (.101), $\phi 2,60$ (.103), $\phi 2,65$ (.105), $\phi 2,70$ (.107), $\phi 2,75$ (.109), $\phi 2,80$ (.111), $\phi 2,85$ (.113), $\phi 2,90$ (.115), $\phi 2,95$ (.117), $\phi 3,00$ (.119)	A		
2 77		A		
2 88		A		
2 89		A		
2 91		A		
2 97		A		
2 97		A		
2 98		A		

*** higher middle tip plus 0,2 mm

		Available tip styles special version GKS-075...LP		
Material	Tip style	Plating	Further versions	
			ϕ	ϕ (inch)
2 91		A		

Note:
 Receptacles for wireless test fixtures shown on page 33.

Ordering example

Receptacles with wire-wrap posts:

KS-075 47 E03 KS-075 47 E05 KS-075 47 G

Receptacles:

KS-075 30 G KS-075 35 G

Receptacles with round post:

KS-075 44 G

GKS 100

ICT-/FCT Test Probe

Grid:

≥ 2,54 mm

≥ 100 Mil

Installation height with KS: 10,5 - 25,5 mm (.413 - 1.004) / variable

Recommended stroke: 4,3 mm (.169)

Mounting and functional dimensions

GKS-100

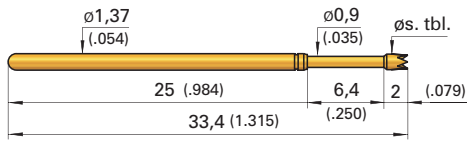

GKS-100 ... LH

(Long version with longer barrel.)

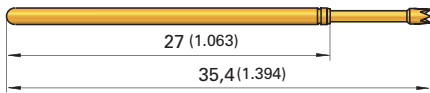

GKS-100 ... LP

(Long version with longer plunger. See "available tip styles".)

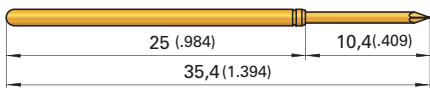

GKS-100 ... E

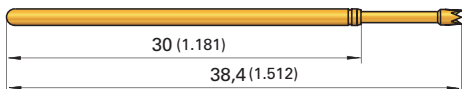

Collar height and installation height

To adjust the installations height, use receptacles (KS) either with collar or with press ring (see Usage Examples on page 29).

Wire-wrap	Solder Cap	GKS-100	GKS-100 ... LH/LP	GKS-100 ... E
KS-100 47 05	KS-100 30 05	10,5 (.413)	12,5 (.492)	15,5 (.610)
KS-100 47 25	KS-100 30 25	13,0 (.512)	15,0 (.591)	18,0 (.709)
KS-100 47 40	KS-100 30 40	14,5 (.571)	16,5 (.650)	19,5 (.768)
KS-100 47	KS-100 30	16,0 (.630)	18,0 (.709)	21,0 (.827)
KS-100 47 G	KS-100 30 G KS-100 44 G ****	16,0 (.630)/var.	18,0 (.709)/var.	21,0 (.827)/var.
KS-100 47 G12	KS-100 30 G12	20,5 (.810)/var.	22,5 (.890)/var.	25,5 (1.000)/var.

**** KS (receptacle) with round post to solder

Mechanical data

Working stroke: 4,3 mm (.169)
Maximum stroke: 6,35 mm (.250)
Spring force at work. stroke: 2,0 N (7.2oz)
Alternative: 0,6 N (2.2oz); 1,0 N (3.6oz);
 1,5 N (5.4oz); 2,25 N (8.1oz);
 3,0 N (10.8oz); 4,0 N (14.4oz)

Electrical data

Current rating: 5 - 8 A
R_i typical: < 20 mΩ (** < 100 mΩ)

Operating temperature

Standard: -40° up to +80° C
*****with special designation "C":**
 -100° up to +200° C (1,5 N; 2,0 N; 3,0 N)
 C-versions only available for GKS-100 with
 total length 33,4 mm (1.315).

Materials

Plunger: BeCu or steel, gold-plated
Barrel: Nickel-silver or Bronze, gold-plated
Spring: Steel, gold-plated
 or stainless steel*** (C)
Receptacle: Nickel-silver or brass,
 gold-plated

Mounting hole size

For KS-100...G when pressing the press ring
 into the mounting hole:
in CEM1: ∅ 1,71 - 1,73 mm (.0673 - .0681)
in FR4: ∅ 1,70 - 1,72 mm (.0669 - .0677)

For KS-100 with collar or press ring as a
 collar-stop:

CEM1 and FR4: ∅ 1,67 - 1,69 mm
 (.0657 - .0665)

Available tip styles

Material	Tip style	Plating	Further versions	
			∅	∅ (inch)
0 06*		A		
0 06*				
2 01		A		
3 02		A	0,90	(.035)
3 03		A		
2 04		A		
2 04		A	1,50	(.059)
3 05		A	0,50 0,64 1,30	(.020) (.025) (.051)
3 06		A	1,50 2,00 2,50 3,00	(.059) (.079) (.098) (.118)
3 07		A		
3 07		A	1,70 2,50	(.067) (.098)
2 09		A		
3 13		A		
2 14		A	0,80	(.031)
2 14		A		
2 14		A	1,50	(.059)
3 14		A		
2 17		A		
3 19		A		
2 24**		A	1,50	(.059)
2 25		A	1,50	(.059)
2 31		A		
2 33		A		

* 0,9 mm or 0,5 mm longer than Standard

** higher middle tip, plus 0,4 mm

Grid:
 ≥ 2,54 mm
 ≥ 100 Mil

Installation height with KS: 10,5 - 25,5 mm (.413 - 1.004)
Recommended stroke: 4,3 mm (.169)

Receptacles with collar

With wire-wrap posts (vacuum-sealed)

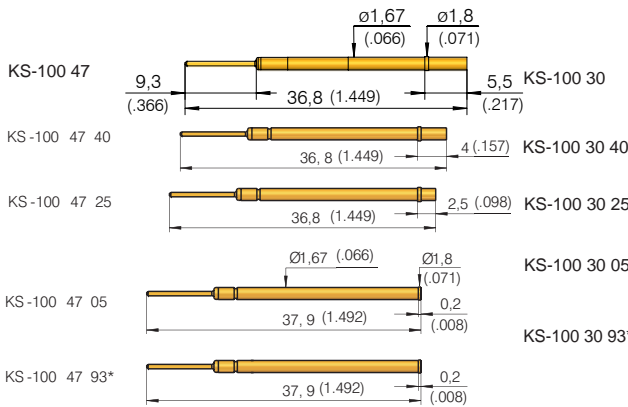

With solder connection

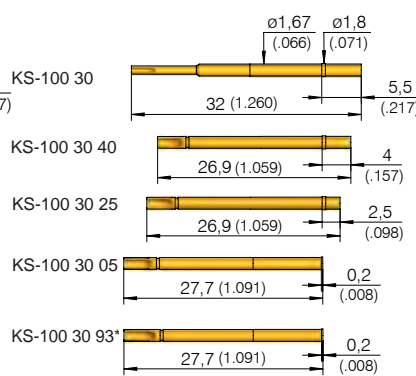

* for use with tip style 93

Receptacles with press ring

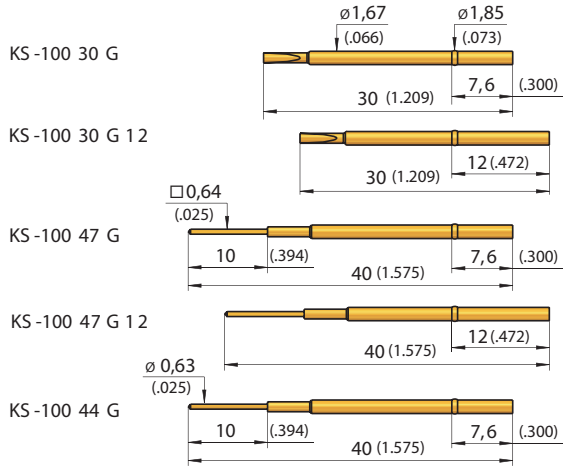

Example with GKS-100 (Total length GKS = 33,4 (1.315))

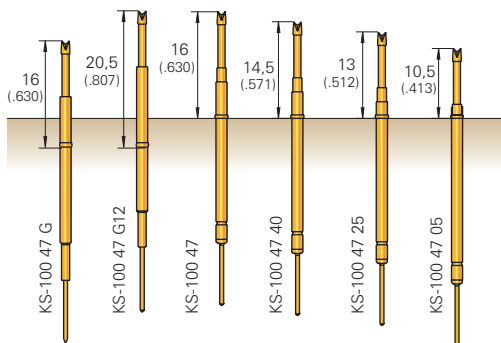

Note to GKS-100 with tip style 93:

- Installation height with KS-100 30/47: 21,0 mm (.827)
 - Installation height with KS-100 47 93: 16,0 mm (.630)
- INGUN recommend using tip style **93** in combination with the **GKS-100 ...E** test probe series

Note:

Receptacles with square-post length 13 mm (.512) and 18 mm (.709) are ordered with the designation **-13** and **-18** respectively.
 Example: KS-100 47 G 12-13 (-18)
 KS-100 47-13 (-18)

Available tip styles

Material	Tip style	Plating	Further versions	
			∅	∅ (inch)
2 38		A	∅ 0,90 (.035)	
3 55		A	∅ 0,64 (.025)	max. stroke: 4,7 mm (.185)
2 77		A	∅ 0,90 (.035)	
2 88		A	∅ 1,50 (.059)	1,90 (.070)
2 89		A	∅ 0,50 (.020)	
2 91		A	∅ 0,90 (.035)	
2 91		A	∅ 1,30 (.051)	
2 93*		A	∅ 1,60 (.063)	
2 97		A	∅ 0,90 (.035)	
2 98		A	∅ 0,90 (.035)	

* 5 mm longer as Standard

Available tip styles special version GKS-100...LP

Material	Tip style	Plating	Further versions	
			∅	∅ (inch)
2 91		A	∅ 0,90 (.035)	
3 07		A	∅ 0,90 (.035)	

Ordering example

Series	Tip material 2 = Steel 3 = BeCu	Tip style	Tip diameter (1/100 mm)	Plating A = Gold	Spring force (dN)	Collar height (mm)	Special designation ("C"; "LH"; "LP"; "E")
Test probe with total length 33,4 mm (1.315):	G K S	1 0 0	3 0 7	1 5 0	A	3 0	0 0
Test probe with total length 35,4 mm (1.394):	G K S	1 0 0	2 9 1	0 9 0	A	2 0	0 0 LP
Test probe with total length 38,4 mm (1.512):	G K S	1 0 0	3 0 6	1 3 0	A	1 5	0 0 E
Receptacles:	K S - 1 0 0 3 0 G		K S - 1 0 0 4 7 G				

GKS 015

Long-stroke Test Probe for Dual-stage Fixtures

Grid:

≥ 1,27 mm

≥ 50 Mil

Installation height with KS: 21,3 / 23,3 mm (.839 / .917) / variable

Recommended stroke: 8,0 mm (.315)

Mounting and functional dimensions

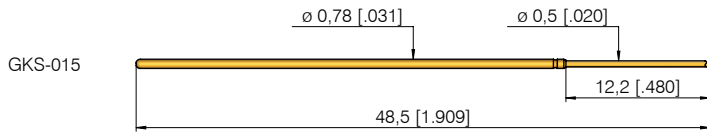

NEW

GKS-015 ... LP

(Long version with longer plunger. See "available tip styles".)

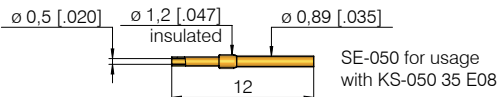
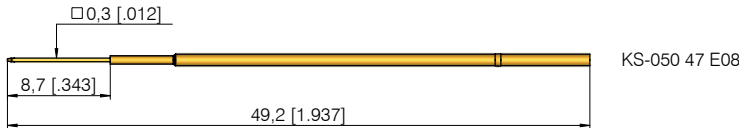
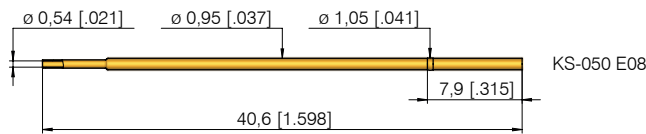
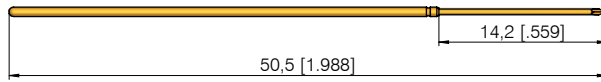

Available tip styles version GKS-015				
Material	Tip styles	Plating	Further versions	
			∅	∅ (inch)
3 07		A	∅ 0,50 (.020)	
2 91		A	∅ 0,50 (.020)	

Available tip styles special version GKS-015...LP				
Material	Tip style	Plating	Further versions	
			∅	∅ (inch)
2 91		A	∅ 0,50 (.020)	

NEW

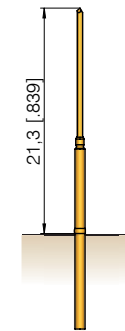

GKS-015
(with KS-050 ... E08)

Collar height and installation height

To adjust the installation height, receptacles with a press ring are used. The receptacles can be inserted up to the press ring (i.e. acting as a collar-stop) or with the press ring being pressed into the mounting hole.

Mechanical data

Working stroke: 8,0 mm (.315)

Maximum stroke: 10 mm (.394)

Spring force at work. stroke: 1,5 N (5.4oz)

Alternative: 1,0 N (3.6oz)

Materials

Plunger: BeCu or steel, gold-plated

Barrel: Bronze, gold-plated

Spring: Steel, gold-plated

Receptacle: BeCu, gold-plated

Electrical Data

Current rating: 2 - 3 A

R_i typical: < 20 mΩ

Mounting hole size

in CEM1 und FR4: ∅ 0,98 - 1,00 mm

(.0386-.0394)

Plug:

Plugs SE-050 and SE-050 V-30 are to be used with the receptacle KS 050 35 E08.

SE-050 V-30 / KS-050 E08 V-30:

The plug and receptacle are pre-wired with 1 m AWG 30 wire. The connection is soldered. Insulation tubing prevents shorts between the receptacles. Minimal recommended bending radius: 10 mm (.394).

Operating temperature

Standard: -40° up to +80° C

Ordering example

Series	Tip material 2 = Steel 3 = BeCu	Tip style	Tip diameter (1/100 mm)	Plating A = Gold	Spring force (dN)	Collar height (mm)	Special designation ("LP")
--------	---------------------------------------	-----------	----------------------------	---------------------	----------------------	-----------------------	-------------------------------

Test probe with total length 48,5 mm (1.909):

G K S 0 1 5 2 9 1 0 5 0 A 1 5 0 0

Test probe with total length 50,5 mm (1.988):

G K S 0 1 5 2 9 1 0 5 0 A 1 5 0 0 L P

Receptacles:

K S - 0 5 0 E 0 8 K S - 0 5 0 3 0 E 0 8 K S - 0 5 0 3 5 E 0 8 K S - 0 5 0 E 0 8 V - 3 0

Plugs:

S E - 0 5 0 S E - 0 5 0 V - 3 0

Grid:
 ≥ 1,91 mm
 ≥ 75 Mil

Installation height with KS: 14,2 - 23,7 mm (.559 / .933) / variable
Recommended stroke: 8,0 mm (.315)

Mounting and functional dimensions

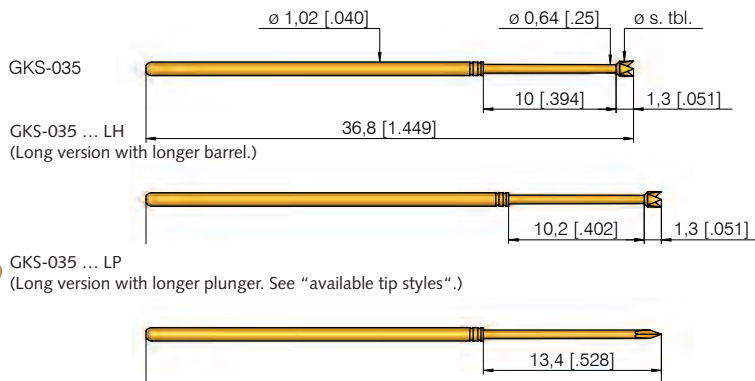

NEW GKS-035 ... LP
 (Long version with longer plunger. See "available tip styles".)

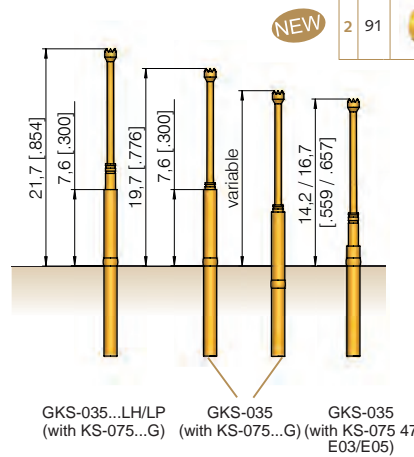
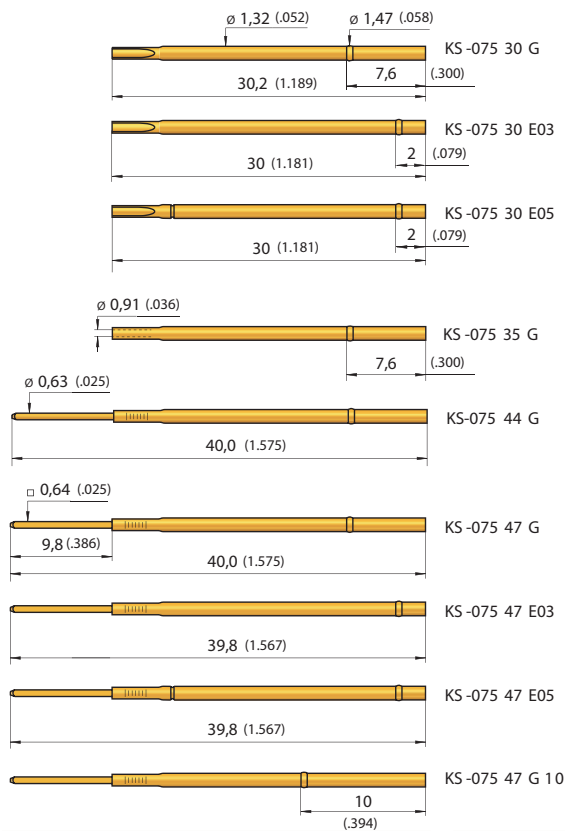

Collar height and installation height

To adjust the installation height receptacles with a press ring are used.

Designation	GKS-035	GKS-035 ... LH/LP
KS-075 ... E03	14,2 mm (.559) / var.	16,2 mm (.638) / var.
KS-075 ... E05	16,7 mm (.657) / var.	18,7 mm (.736) / var.
KS-075 ... G	19,7 mm (.776) / var.	21,7 mm (.827) / var.
KS-075 ... G10	21,7 mm (.827) / var.	23,7 mm (.933) / var.

Mechanical data

Working stroke: 8,0 mm (.315)
Maximum stroke: 10,0 mm (.394)
Spring force at work. stroke: 1,2 N (4.3oz)

Mounting hole size

Press-ring pressed in mounting hole:
 ∅ 1,39-1,40 mm (.0547-.0551)
Pressing as collar-stop:
in CEM1: ∅ 1,30-1,32 mm (.0512-.0520)
in FR4: ∅ 1,31-1,33 mm (.0516-.0524)

Materials

Plunger: BeCu or steel, gold-plated
Barrel: Nickel-silver or Bronze, gold-plated
Spring: Steel, gold-plated
Receptacles: Nickel-silver, gold-plated

Electrical data

Current rating: 3 - 4 A
R_j typical: < 20 mΩ

Note:

Receptacles in the KS-075 series are used for the GKS-035 test probes series.

Operating temperature

Standard: -40° up to +80° C

Ordering example

	Series	Tip material 2 = Steel 3 = BeCu	Tip style	Tip diameter (1/100 mm)	Plating A = Gold	Spring force (dN)	Collar height (mm)	Special designation ("LH"; "LP")
Test probe with total length 36,8 mm (1.449):	G K S	0 3 5	2 1 4	1 1 5	A	1 2	0 0	
Test probe with total length 38,8 mm (1.528):	G K S	0 3 5	2 9 1	0 6 4	A	1 2	0 0	LH
Test probe with total length 38,8 mm (1.528):	G K S	0 3 5	2 9 1	0 6 4	A	1 2	0 0	LP
Receptacles with wire-wrap post:	K S - 0 7 5 4 7 E 0 3		K S - 0 7 5 4 7 E 0 5		K S - 0 7 5 4 7 G			
Receptacles:	K S - 0 7 5 3 0 G		K S - 0 7 5 3 5 G					

All specifications are subject to change without prior notification

GKS 135

Long-stroke Test Probe for Dual-stage Fixtures

Grid:

≥ 2,54 mm

≥ 100 Mil

Installation height with KS: 15,8 - 21,3 mm (.622 / .839) / variable

Recommended stroke: 9,3 mm (.366)

Mounting and functional dimensions

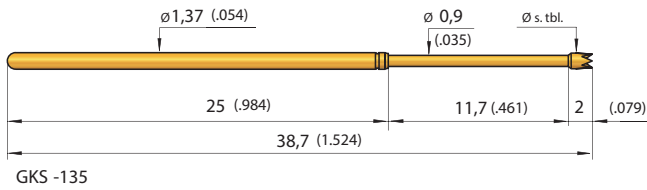

Collar height and installation height

The installation height of the test probe is determined by the collar height of the receptacle (KS).

Designation	Install. height with KS
KS-100 47 05	15,8 mm (.622)
KS-100 47 25	18,3 mm (.720)
KS-100 47 40	19,8 mm (.780)
KS-100 47 (G)	21,3 mm (.839) var.

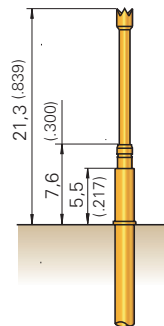

Application example with KS - 100 47

Available tip styles

Material	Tip style	Plating	Further versions	
			∅	∅ (inch)
2	01	A	∅ 0,90 (.035)	
3	02	A	∅ 0,90 (.051)	
3	03	A	∅ 1,30 (.035)	
2	04	A	∅ 1,30 (.051)	
3	06	A	∅ 1,30 (.051)	
3	06	A	∅ 1,50 (.059)	
3	07	A	∅ 1,50 (.059)	2,50 (.098)
2	09*	N	∅ 0,50 (.020)	
2	14	A	∅ 0,50 (.020)	
2	14	A	∅ 1,30 (.051)	
2	14	A	∅ 1,50 (.059)	
2	25	A	∅ 1,30 (.051)	
2	91	A	∅ 0,90 (.035)	
2	97	A	∅ 0,90 (.035)	

* installation height with KS-100 47: 23,3 mm (.917)
maximum stroke: 11,0 mm (.433)

Mechanical data

Working stroke: 9,3 mm (.366)
Maximum stroke: 11,5 mm (.453)
Spring force at work. stroke: 2,0 N (7.2oz)
Alternative: 1,5 N (5.4oz); 3,0 N (10.8oz)

Materials

Plunger: Steel or BeCu, gold- or nickel-plated
Barrel: Nickel-silver or Bronze, gold-plated
Spring: Steel, gold-plated

Note:

Receptacles in the series KS-100 (shown on page 29) are used for the GKS-135 test probes series.

Electrical data

Current rating: 5 - 8 A
R_i typical: < 30 mΩ

Mounting hole size

see GKS-100 series, shown on page 28

Operating temperature

Standard: -40° up to +80° C

Ordering example

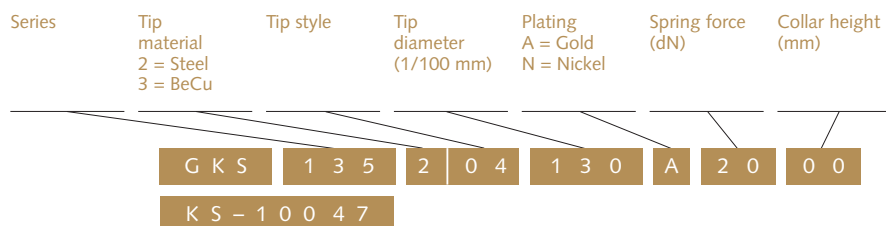

Grid:

≥ 1.00 / 1,27 / 1,91 / 2,54 mm
≥ 40 / 50 / 75 / 100 Mil

Installation height with KS: 16,0 mm (.630) / variable
Recommended stroke: 2,5 mm (.098)

Mounting and functional dimensions

Wireless receptacles

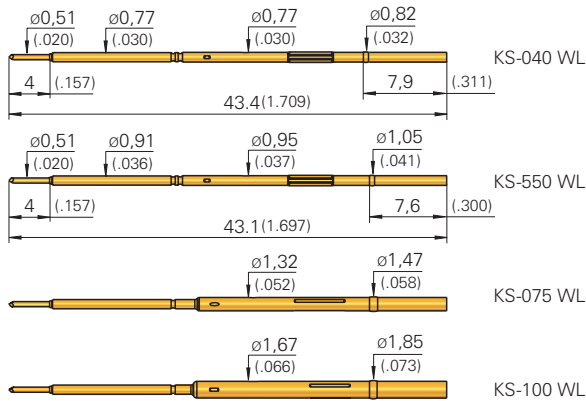

Available tip styles plunger in receptacle

Material	Tip style	Plating	Further versions	
			∅	∅ (inch)
3	07	A		

Collar height and installation height

To adjust the installation height, receptacles with a press ring are used. The receptacles can be inserted up to the press ring (i.e. acting as a collar-stop) or with the press ring being pressed into the mounting hole.

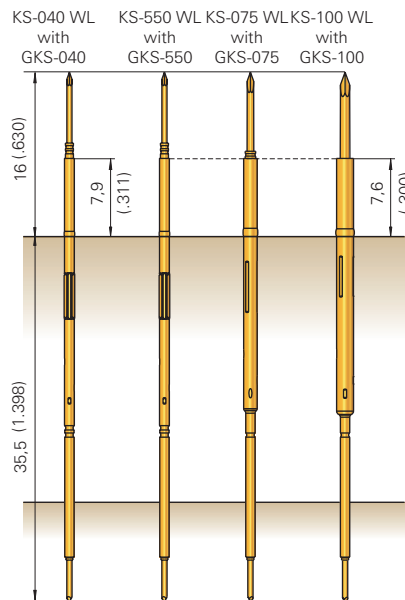

Mounting hole Sizes

KS-040 WL

with use of press ring or with use of press ring as a collar:

in CEM1: ∅ 0,79-0,80 mm (.0311-.0315)
in FR4: ∅ 0,79-0,80 mm (.0311-.0315)

KS-550 WL

with use of press ring or with use of press ring as a collar:

in CEM1: ∅ 0,96-0,98 mm (.0378 - .0386)
in FR4: ∅ 0,97-0,99 mm (.0382 - .0390)

KS-075 WL

with use of press ring in:

CEM1/FR4: ∅ 1,36-1,40 mm (.0535-.0551)
with use of press ring as a collar in:
CEM1/FR4: ∅ 1,31-1,32 mm (.0516-.0520)

KS-100 WL

with use of press ring in:

CEM1/FR4: ∅ 1,70-1,75 mm (.0669-.0689)
with use of press ring as a collar in:
in CEM1: ∅ 1,68-1,69 mm (.0661-.0665)
in FR4: ∅ 1,69-1,70 mm (.0665-.0669)

Mechanical data

Working stroke: 2,5 mm (.098)
Maximum stroke: 4,0 mm (.157)
Spring force at work.stroke: 1,0 N (3.6oz)
Pre-load: 0,6 N (2.2oz)
Pre-load at KS-040 WL: 0,5 N (1,8oz)
Recomm. guiding pin hole:
KS-040: ∅ 0,81-0,85 mm (.032-.033)
KS-050 / 075 / 100: ∅ 0,96-0,99 mm (.038-.039)

Materials

Plunger: BeCu, gold-plated
Ball: Steel, gold-plated
Spring: Steel, gold-plated
Receptacle: Nickel-silver, gold-plated

Operating temperature

Standard: -40° up to +80° C

Electrical data

Current rating: 2 - 3 A
R_i typical: < 20 mΩ

Ordering example

Series	Tip material 2 = Steel 3 = BeCu	Tip style	Tip diameter (1/100 mm)	Plating A = Gold	Spring force (dN)	Collar height (mm)
--------	---------------------------------------	-----------	----------------------------	---------------------	----------------------	-----------------------

Test probe for KS 550 WL:

G K S 5 5 0 2 9 1 0 5 0 A 1 5 0 0

Receptacle for grid 1,00 mm (40 Mil):

K S - 0 4 0 W L

Test probes see GKS-040 page 24

Receptacle for grid 1,27 mm (50 Mil):

K S - 5 5 0 W L

Test probes see GKS-550 page 34

Receptacle for grid 1,91 mm (75 Mil):

K S - 0 7 5 W L

Test probes see GKS-075 page 26/27

Receptacle for grid 2,54 mm (100 Mil):

K S - 1 0 0 W L

Test probes see GKS-100 page 28/29

GKS 550

Wireless Test Probes

Grid:

≥ 1,27 mm

≥ 50 Mil

Installation height with KS: 16,0 mm (.630) / variable

Recommended stroke: 4,3 mm (.169)

Mounting and functional dimensions

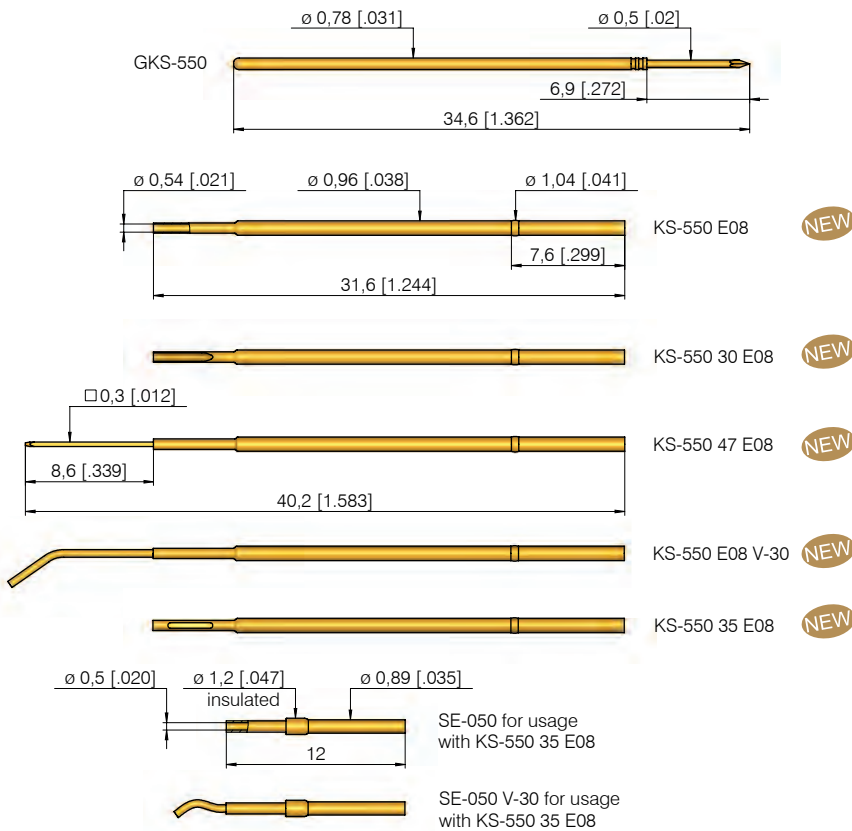

Available tip styles

Material	Tip styles	Plating	Further versions	
			\varnothing	\varnothing (inch)
2	01	A	$\varnothing 0,50$ (.020)	
3	02	A	$\varnothing 0,60$ (.024)	
3	03	A	$\varnothing 0,50$ (.020)	0,90 (.035)
3	05	A	$\varnothing 0,50$ (.020)	
3	06	A	$\varnothing 0,90$ (.035)	
3	07	A	$\varnothing 0,50$ (.020)	0,90 (.035)
2	14	A	$\varnothing 0,50$ (.020)	
2	22*	A	$\varnothing 0,40$ (.016)	
2	31	A	$\varnothing 0,50$ (.020)	
2	38	A	$\varnothing 0,50$ (.020)	
2	77	A	$\varnothing 0,50$ (.020)	
2	91	A	$\varnothing 0,50$ (.020)	
2	97	A	$\varnothing 0,50$ (.020)	

* conical down to $\varnothing 0,50$ mm

Collar height and installation height

To adjust the installation height, receptacles with a press ring are used. The receptacles can be inserted up to the press ring (i.e. acting as a collar-stop) or with the press ring being pressed into the mounting hole.

Mechanical data

Working stroke: 4,3 mm (.169)
Maximum stroke: 6,35 mm (.250)
Spring force at work. stroke: 1,5 N (5.4oz)
Alternative: 1,0 N (3.6oz); 2,0 N (7.2oz)

Materials

Plunger: BeCu or steel, gold-plated
Barrel: Bronze, gold-plated
Spring: Steel, gold-plated
Receptacle: BeCu, gold-plated

SE-050 V-30 / KS-550 E08 V-30:

The plug and receptacle are pre-wired with 1 m AWG 30 wire. The connection is soldered. Insulation tubing prevents shorts between the receptacles. Recommended minimal bending radius: 10 mm (.394).

Elektrical Data

Current rating: 2 - 3 A
R_i typical: < 20 m Ω

Mounting hole size

in CEM1: $\varnothing 0,96 - 0,98$ mm (.0378-.0386)
in FR4: $\varnothing 0,97 - 0,99$ mm (.0382-.0390)

Operating temperature

Standard: -40° up to +80° C

Ordering example

	Series	Tip material 2 = Steel 3 = BeCu	Tip style	Tip diameter (1/100 mm)	Plating A = Gold	Spring force (dN)	Collar height (mm)	Special designation
Test probe	G K S	5 5 0	2	9 1	0 5 0	A	1 5	0 0
Receptacles:	KS-550 E08	KS-550 30 E08	KS-550 35 E08	KS-550 E08 V-30				
Plug:	SE-050	SE-050 V-30						

Grid:
 ≥ 1,91 mm
 ≥ 75 Mil

Installation height with KS: 12,5 / 14,0 mm (.492 / .551)
 Recommended stroke: 4,0 mm (.157)

Mounting and functional dimensions

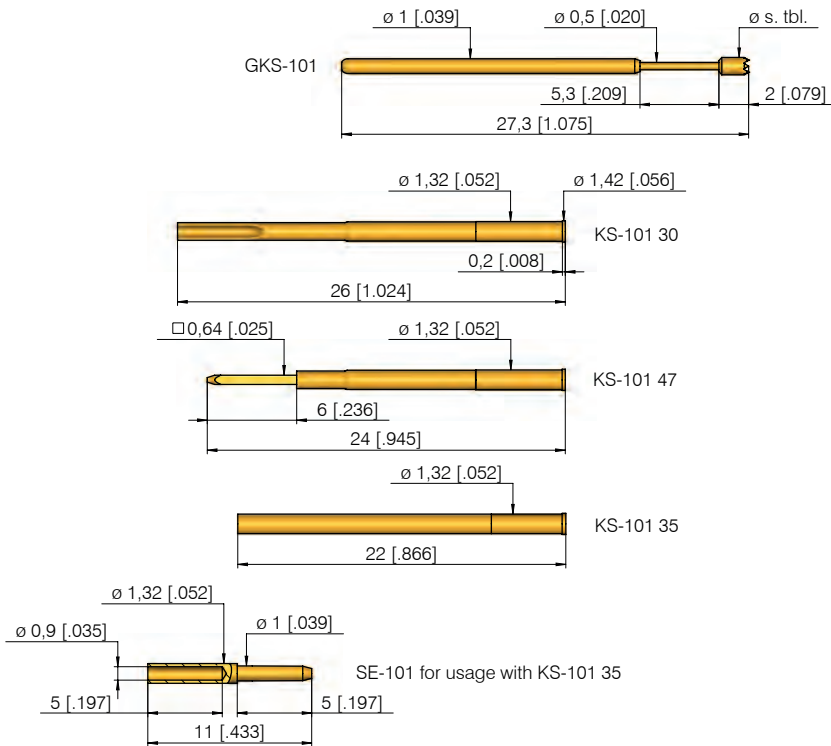

Available tip styles

Material	Tip style	Plating	Further versions	
			Ø	Ø (inch)
3	01	A	Ø 0,50 (.020)	
3	02	A	0,50	(.020)
3	03	A	1,50	(.059)
3	04	A		
3	05	A		
3	06	A	1,50	(.059)
3	07	A		
3	08	A		
3	14	A		
2	24 **	A		
3	51	A		

** higher middle tip plus 0,5 mm

Collar height an installation height

The installation height of the test probe is determined by the collar height of the receptacle (KS).

Designation	Install. height with KS
KS-101 30/35/47	12,5 mm (.492)
KS-101 xx E13	14,0 mm (.551)
Further installation heights on request.	

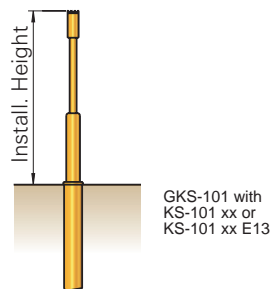

Mechanical data

Working stroke: 4,0 mm (.157)
 Maximum stroke: 5,3 mm (.209)
 Spring force at work. stroke: 0,8 N (2.9oz)
 Alternative: 0,5 N (1.8oz); 1,5 N (5.4oz)

Materials

Plunger: BeCu or steel, gold-plated
 Barrel: Nickel-silver, gold-plated
 Spring: Steel, gold-plated or stainless steel* (C)
 Receptacle: Brass or Nickel-silver, gold-plated

Electrical data

Current rating: 3 - 4 A
 R_i typical: < 20 mΩ (* < 100 mΩ)

Mounting hole size

in CEM1: Ø 1,29 - 1,31 mm (.0508 - .0516)
 in FR4: Ø 1,30 - 1,32 mm (.0512 - .0520)

Operating temperature

Standard: -40° up to +80° C
 * with spec. designation "C": -100° up to +200° (0,8 N)

Ordering example

	Series	Tip material 2 = Steel 3 = BeCu	Tip style	Tip diameter (1/100 mm)	Plating A = Gold	Spring force (dN)	Collar height (mm)
Test probe:	G K S	1 0 1	3	0 1	0 5 0	A	0 8 0 0
Receptacles:	K S - 1 0 1 4 7	K S - 1 0 1 3 5	K S - 1 0 1 3 0 E 1 3				
Plug:	S E - 1 0 1						

Grid:

≥ 1,91 mm

≥ 75 Mil

Installation height with KS: 8,5 mm (.335)/variable

Recommended stroke: 2,4 mm (.094)

Mounting and functional dimensions

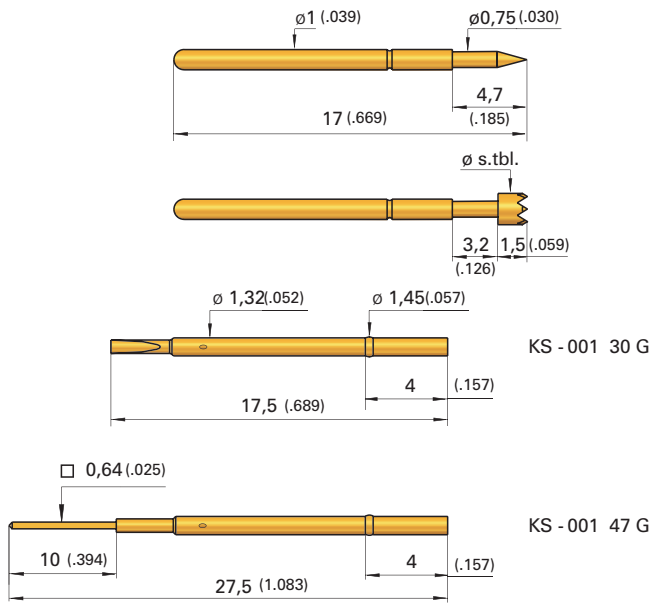

Available tip styles

Material	Tip style	Plating	Further versions	
			∅	∅ (inch)
2	01	A	∅ 0,75 (.030)	
3	02	A	∅ 1,50 (.059)	
3	03	A	∅ 1,50 (.059)	
2	04	A	∅ 1,50 (.059)	
3	05	A	∅ 1,00 (.039)	
3	06	A	∅ 1,00 (.039)	
3	06	A	∅ 1,50 (.059)	
3	07	A	∅ 1,50 (.059)	

Collar height and installation height

To adjust the installation height, receptacles with press ring (end designation "G") are used. The installation height can be adjusted by assembling the collar lower in the mounting hole.

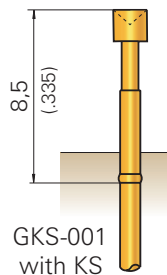

Mechanical data

Working stroke: 2,4 mm (.094)

Maximum stroke: 3,0 mm (.118)

Spring force at work. stroke: 1,0 N (3.6oz)

Alternative: 0,6 N (2.2oz); 1,5 N (5.4oz)

Materials

Plunger: BeCu or steel, gold-plated

Barrel: Nickel-silver or Bronze, gold-plated

Spring: Steel, gold-plated

Receptacle: Nickel-silver, gold-plated

Electrical data

Current rating: 3 - 4 A

R_i typical: < 20 mΩ

Mounting hole size

With collar or press ring as a collar-stop in CEM1 and FR4: ∅ 1,31 - 1,32 mm (.0516 - .0520)

When pressing the press ring into the mounting hole in CEM1 and FR4: ∅ 1,36 - 1,40 mm (.0535 - .0551)

Operating temperature

Standard: -40° up to +80° C

Ordering example

Series	Tip material 2 = Steel 3 = BeCu	Tip style	Tip diameter (1/100 mm)	Plating A = Gold	Spring force (dN)	Collar height (mm)
--------	---------------------------------------	-----------	----------------------------	---------------------	----------------------	-----------------------

Test probe:

G K S 0 0 1 2 1 4 1 5 0 A 1 0 0 0

Receptacles with press-ring:

K S - 0 0 1 3 0 G K S - 0 0 1 4 7 G

Grid:
 ≥ 2,54 mm
 ≥ 100 Mil

Installation height with KS: 12,1 mm (.476)/variable
 Recommended stroke: 2,7 mm (.106)

Mounting and functional dimensions

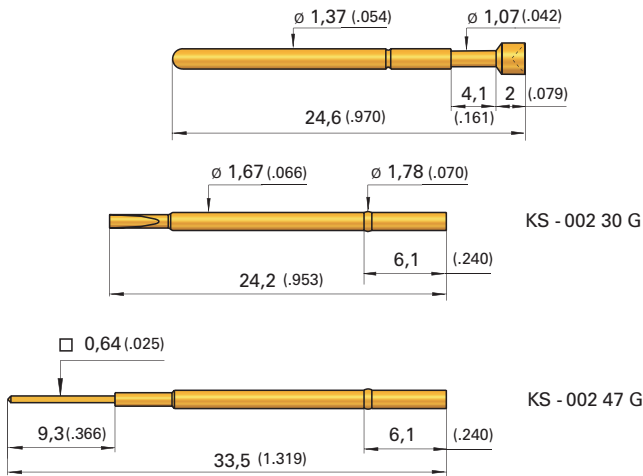

		Available tip styles			
Material	Tip style	Plating	Further versions		
			\varnothing	\varnothing (inch)	
2	01	A	$\varnothing 1,07$ (.042)		
3	03	A	$\varnothing 1,91$ (.075)		
2	04	A	$\varnothing 1,52$ (.060)		
3	05	A	$\varnothing 0,64$ (.025)	1,8	
2	06	A	$\varnothing 1,91$ (.075)		
2	07	A	$\varnothing 1,91$ (.075)		
2	14	A	$\varnothing 1,91$ (.075)		
2	17	A	$\varnothing 1,91$ (.075)		

Collar height and installation height

To adjust the installation height, receptacles with press ring (end designation "G") are used. The installation height can be adjusted by assembling the collar lower in the mounting hole.

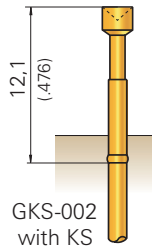

Mechanical data

Working stroke: 2,7 mm (.106)
Maximum stroke: 4,1 mm (.161)
Spring force at work. stroke: 1,0 N (3.6oz)
Alternative: 1,8 N (6.5oz); 2,8 N (10.1oz)

Materials

Plunger: BeCu or steel, gold-plated
Barrel: Nickel-silver or Bronze, gold-plated
Spring: Steel, gold-plated
Receptacle: Nickel-silver, gold-plated

Electrical data

Current rating: 5 - 8 A
R_i typical: < 20 m Ω

Mounting hole size

With collar or press ring as a collar-stop in CEM1 and FR4: $\varnothing 1,68 - 1,69$ mm (.0642 - .0660)

Operating temperature

Standard: -40° up to +80° C

When pressing the press ring into the

Mounting hole in CEM1 and FR4: $\varnothing 1,70 - 1,75$ mm (.0669 - .0689)

Ordering example

Series	Tip material 2 = Steel 3 = BeCu	Tip style	Tip diameter (1/100 mm)	Plating A = Gold	Spring force (dN)	Collar height (mm)
--------	---------------------------------------	-----------	----------------------------	---------------------	----------------------	-----------------------

Test probe:

G K S 0 0 2 3 0 3 1 9 1 A 1 0 0 0

Receptacle with press ring:

K S - 0 0 2 3 0 G K S - 0 0 2 4 7 G

Grid:

≥ 3,18 mm

≥ 125 Mil

Installation height with KS: 16 mm (.630)/variable

Recommended stroke: 4,4 mm (.173)

Mounting and functional dimensions

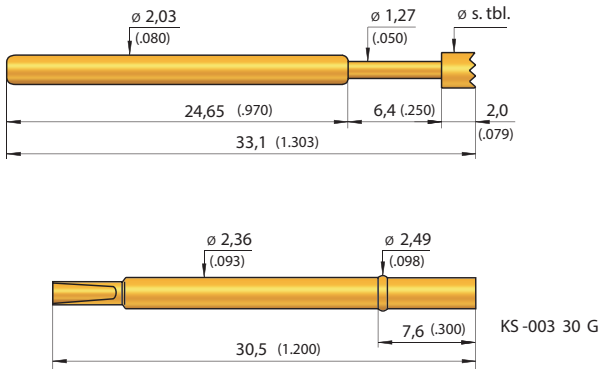

Available tip styles

Material	Tip style	Plating	Further versions	
			∅	∅ (inch)
2 01		A	∅ 1,27 (.050)	
3 02		A	∅ 1,00 (.039)	
3 02		A	∅ 1,27 (.050)	
3 03		A	∅ 2,54 (.100)	
2 04		A	∅ 2,54 (.100)	
3 05		A	∅ 1,27 (.050)	
3 05		A	∅ 1,70 (.067)	
3 05		A	∅ 2,54 (.100)	
2 06		A	∅ 2,54 (.100)	
3 07		A	∅ 2,54 (.100)	3,00 (.118)
3 08		A	∅ 2,54 (.100)	

Collar height and installation height

To adjust the installation height, receptacles with press ring (end designation "G") are used. The installation height can be adjusted by assembling the collar lower in the mounting hole.

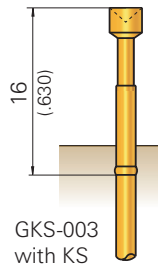

Mechanical data

Working stroke: 4,4 mm (.173)

Maximum stroke: 6,35 mm (.250)

Spring force at work. stroke: 2,0 N (7.2oz)

Alternative 1,2 N (4.3oz); 3,0 N (10.8oz)

Materials

Plunger: BeCu or steel, gold-plated

Barrel: Nickel-silver or Bronze, gold-plated

Spring: Steel, gold-plated

Receptacle: Nickel-silver, gold-plated

Electrical data

Current rating: 5 - 8 A

R_i typical: < 20 mΩ

Mounting hole size

With collar or press ring as a collar-stop in CEM1 and FR4: ∅ 2,33- 2,34 mm (.0901 - .0906)

When pressing the press ring into the Mounting hole in CEM1 and FR4: ∅ 2,39 - 2,44 mm (.0941 - .0961)

Operating temperature

Standard: -40° up to +80° C

Ordering example

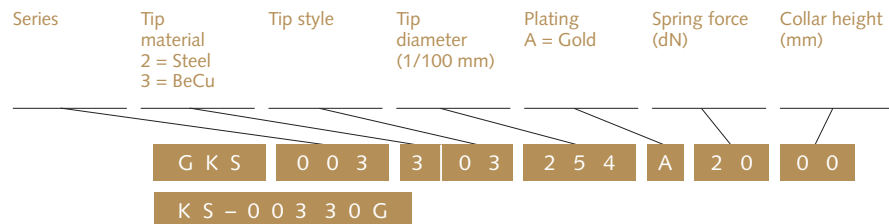

Test probe:

Receptacle with press ring:

Grid:
 ≥ 4,75 mm
 ≥ 187 Mil

Installation height with KS: 16,5 mm (.650)/variable
 Recommended stroke: 4,4 mm (.173)

Mounting and functional dimensions

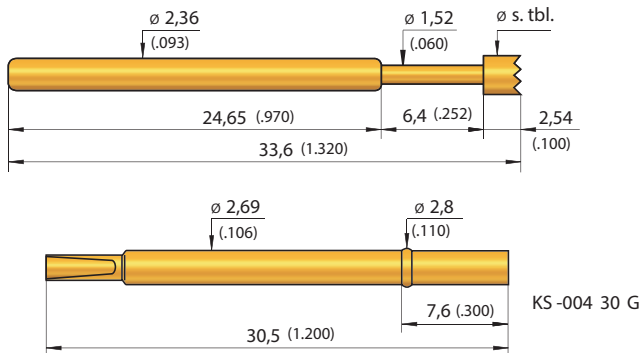

		Available tip styles		
Material	Tip style	Plating	Further versions	
			\varnothing	\varnothing (inch)
2	01	A	$\varnothing 1,52$ (.060)	
3	02	A	$\varnothing 3,96$ (.156)	
2	03	A	$\varnothing 3,96$ (.156)	
2	04	A	$\varnothing 1,52$ (.060)	
3	05	A	$\varnothing 1,52$ (.060)	
2	06	A	$\varnothing 3,96$ (.156)	
3	08	A	$\varnothing 3,96$ (.156)	

Collar height and installation height

To adjust the installation height, receptacles with a press ring (end designation "G") are used. The installation height can be adjusted by assembling the collar lower in the mounting hole.

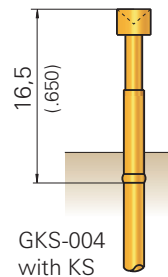

Mechanical data

Working stroke: 4,4 mm (.173)
Maximum stroke: 6,35 mm (.250)
Spring force at work. stroke: 2,0 N (7.2oz)
Alternative: 1,5 N (5.4oz); 3,0 N (10.8oz)

Materials

Plunger: Steel, gold-plated
Barrel: Nickel-silver or Bronze, gold-plated
Spring: Steel, gold-plated
Receptacle: Nickel-silver, gold-plated

Electrical data

Current rating: 6 - 8 A
R_i typical: < 20 m Ω

Mounting hole size

With collar or press ring as a collar-stop in CEM1 and FR4: $\varnothing 2,67 - 2,68$ mm (.1024 - .1063)

Operating temperature

Standard: -40° up to +80° C

When pressing the press ring into the Mounting hole

KS-004 30 G: $\varnothing 2,72 - 2,77$ mm (.1071 - .1091)

Ordering example

Series	Tip material 2 = Steel 3 = BeCu	Tip style	Tip diameter (1/100 mm)	Plating A = Gold	Spring force (dN)	Collar height (mm)
--------	---------------------------------------	-----------	----------------------------	---------------------	----------------------	-----------------------

Test probe:

G K S 0 0 4 2 0 1 1 5 2 A 2 0 0 0

Receptacle with press ring:

K S - 0 0 4 3 0 G

GKS 005

ICT-/FCT Test Probe

Grid:

≥ 4,75 mm

≥ 187 Mil

Installation height with KS: 16,5 mm (.650)/variable

Recommended stroke: 4,4 mm (.173)

Mounting and functional dimensions

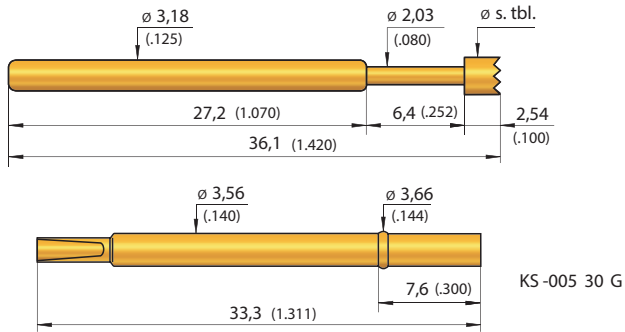

Available tip styles

Material	Tip style	Plating	Further versions	
			∅	∅ (inch)
2 01	∅ 2.03 (.080)	A		
2 03	∅ 3.96 (.156)	A		
2 06	∅ 3.96 (.156)	A		

Collar height and installation height

To adjust the installation height, receptacles with a press ring (end designation "G") are used. The installation height can be adjusted by assembling the collar lower in the mounting hole.

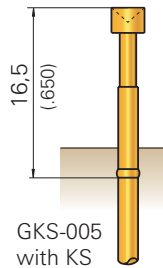

Mechanical data

Working stroke: 4,4 mm (.173)

Maximum stroke: 6,35 mm (.250)

Spring force at work. stroke: 2,0 N (7.2oz)

Alternative: 3,0 N (10,8oz); 5,0 N (18.1oz)

Materials

Plunger: Steel, gold-plated

Barrel: Nickel-silver or Bronze, gold-plated

Spring: Steel, gold-plated

Receptacle: Nickel-silver, gold-plated

Electrical data

Current rating: 6 - 8 A

R_i typical: < 20 mΩ

Mounting hole size

With collar or press ring as a collar-stop in CEM1 and FR4: ∅ 3,53 - 3,54 mm (.1378 - .1399)

When pressing the press ring into the Mounting hole in CEM1 and FR4: ∅ 3,58 - 3,63 mm (.1409 - .1429)

Operating temperature

Standard: -40° up to +80° C

Ordering example

Series	Tip material	Tip style	Tip diameter (1/100 mm)	Plating A = Gold	Spring force (dN)	Collar height (mm)
	2 = Steel					

Test probe:

G K S 0 0 5 2 0 6 3 9 6 A 3 0 0 0

Receptacle with press ring:

K S - 0 0 5 3 0 G

INGUN E-TYPE® Rotating Test Probes

INGUN E-TYPE® test probes enable the highest contact security on the PCB/UUT without additional stress. When contacting on the test surface, up to a 100% higher spring force is available, which is achieved by the increased spring pre-load of the E-TYPE probes. During the working stroke, however, the E-TYPE probes have the same spring force as standard test probes. The additional contact energy gained ensures a contact area between the test probe and the PCB which is up to 25% larger.

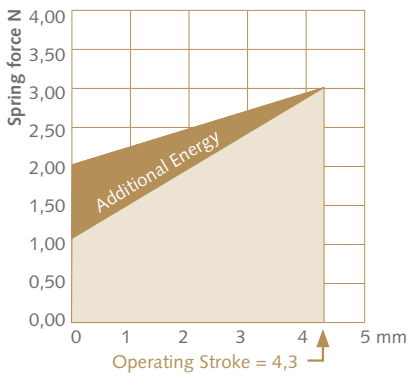

INGUN E-TYPE® probes are supplied in all current grid sizes (50, 75, 100 Mil), and are compatible with the standard GKS-050/075/100/422 series.

Rotating test probes are recommended for the secure contact of heavily contaminated components, anodised aluminium, or similar plated surfaces. During the contacting process, the rotating plunger of the test probe pierces the surface of the PCB reliably penetrating the contact surface. However, it must be taken into consideration that the maintenance rate must be adjusted because of the increased amount of particles. INGUN DKS-050/075/100 are 100% compatible with the standard series GKS-050/075/100.

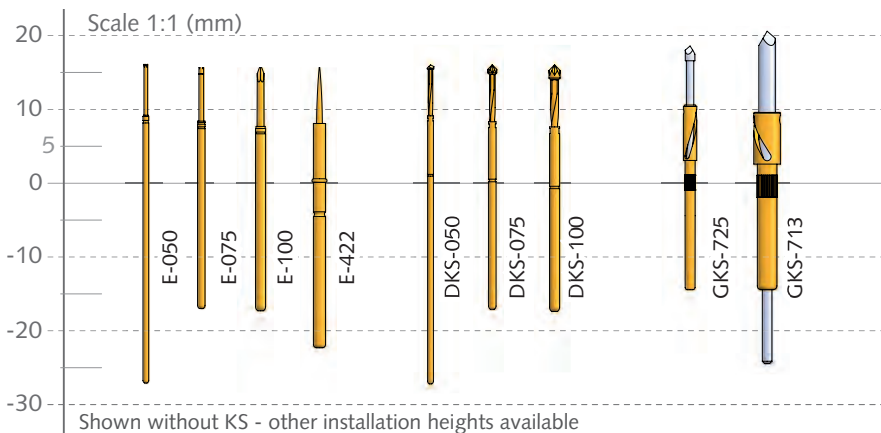

INGUN E-TYPE®

E-050	42
E-075	42
E-100	43
E-422	43

Rotating Test Probes DKS

DKS-050	44
DKS-075	44
DKS-100	44
GKS-725	45
GKS-713	46

Note:
See page 22 for overview and comparison table.

INGUN E-TYPE® E-050 / E-075

Grid:
1,27 / 1,91 mm
50 / 75 Mil
Installation height with KS: 16,0 mm (.630) / variable
Recommended stroke: 4,3 mm (.169)

Mounting and functional dimensions

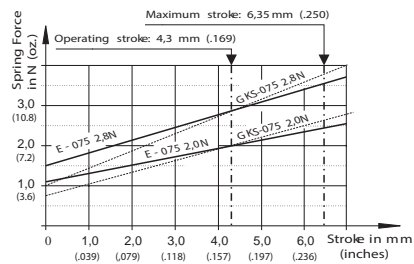
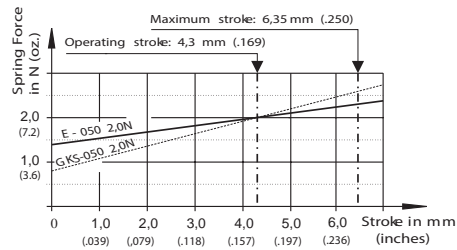
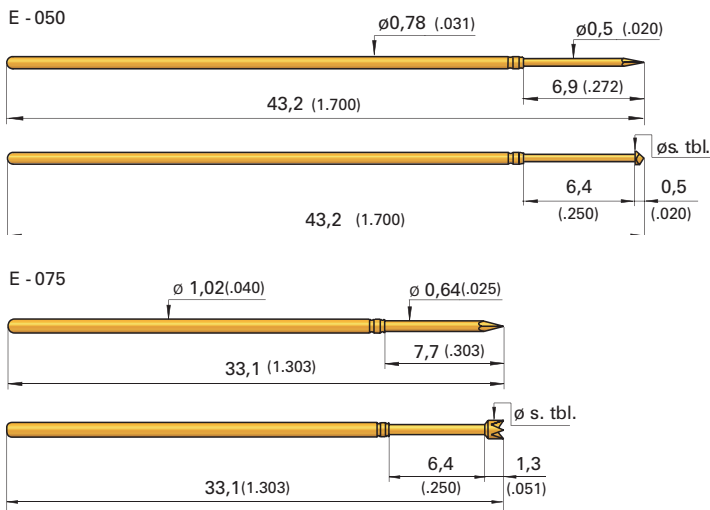

Collar height and installation height, receptacles, electrical data, operating temperature, mounting hole size and materials: see compatible standard probe series GKS-050/075

e-type	Compatible probe	Page
E-050	GKS-050	25
E-075	GKS-075	26 / 27

Spring forces at working stroke

Series	Designation	Pre-load	Force at work. stroke
E-050	20	1,2 N (4.3oz)	2,0 N (7.2 oz)
E-075	20	1,2 N (4.3oz)	2,0 N (7.2 oz)
E-075	28	1,6 N (5,8oz)	2,8 N (10.1 oz)

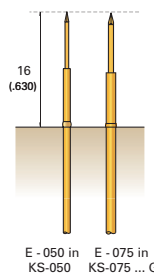

Available tip styles E-050

Material	Tip style	Plating	Further versions	
			∅	∅ (inch)
2	01	A		
3	07	A	0,90	A
2	14	A		
2	38	A		
2	77	A		
2	91	A		
2	97	A		

Available tip styles E-075

Material	Tip style	Plating	Further versions	
			∅	∅ (inch)
2	01	A		
2	07	A	1,20	(.047)
2	09	A		
NEW 2	14	A		
2	14	A	1,00	(.039)
2	24*	A		
2	38	A		
2	77	A		
2	91	A		
2	97	A		
2	98	A		

* higher middle tip plus 0,2 mm

Mechanical data

Working stroke: 4,3 mm (.169)
Maximum stroke: 6,35 mm (.250)

Ordering example

Series	Tip material 2 = Steel 3 = BeCu	Tip style	Tip diameter (1/100 mm)	Plating A = Gold	Spring force (dN)	Collar height (mm)	
E	050	2	91	050	A	20	00
E	075	2	91	064	A	20	00

Test probes:

Grid:
 ≥ 2,54 mm
 ≥ 100 Mil

Installation height with KS: 16,0 mm (.630) / variable
 Recommended stroke: 4,3 mm (.169) bzw. 6,4 mm (.252)

Mounting and functional dimensions

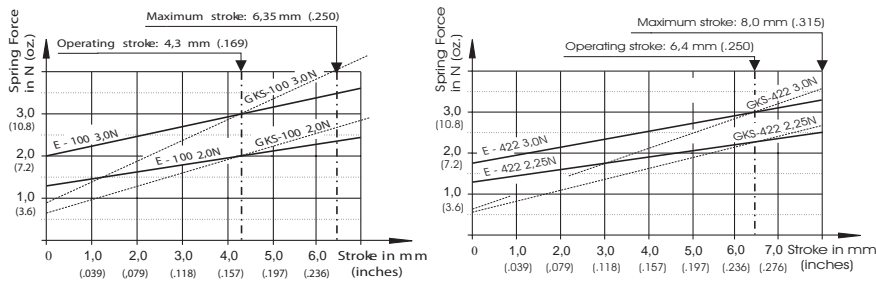
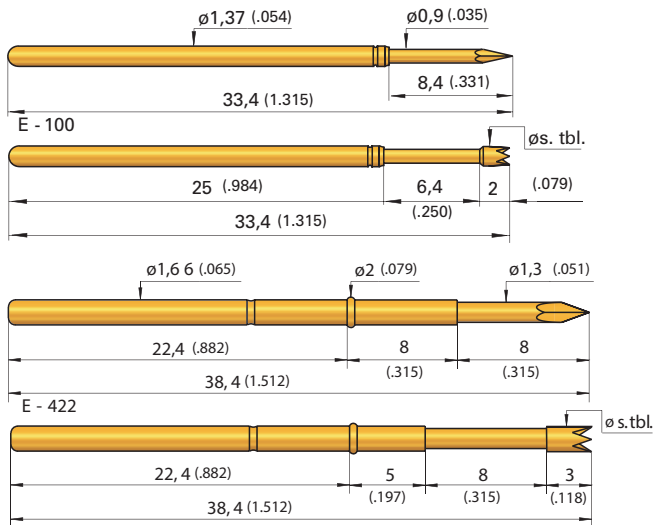

Collar height and installation height, receptacles, electrical data, operating temperature, mounting hole size and materials: see compatible standard probe series GKS-100/422

e-type	Compatible probe	Page
E-100	GKS-100	28 / 29
E-422	GKS-422	63

Spring forces at working stroke

Series	Designation	Pre-load	Force at work. stroke
E-100	20	1,3 N (4.7 oz)	2,0 N
E-100	30	2,0 N (7.2oz)	3,0 N
E-422	22	1,3 N (4.7oz)	2,25 N
E-422	30	1,8 N (6.5oz)	3,0 N

Mechanical data E-100
 Working stroke: 4,3 mm (.169)
 Maximum stroke: 6,35 mm (.250)

Mechanical data E-422
 Working stroke: 6,4 mm (.250)
 Maximum stroke: 8,0 mm (.315)

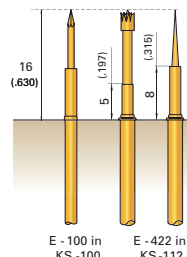

Available tip styles E-100

Material	Tip style	Plating	Further versions	
			ϕ	ϕ (inch)
2 01		A	$\phi 0,90$ (.035)	
3 07		A	$\phi 0,90$ (.035)	
3 07		A	$\phi 1,50$ (.059)	
2 09		A	$\phi 0,60$ (.024)	
2 14		A	$\phi 0,50$ (.020)	
2 14		A	$\phi 1,30$ (.051)	
2 24*		A	$\phi 1,30$ (.051)	
2 38		A	$\phi 0,90$ (.035)	
2 77		A	$\phi 0,90$ (.035)	
2 91		A	$\phi 0,90$ (.035)	
2 97		A	$\phi 0,90$ (.035)	
2 98		A	$\phi 0,90$ (.035)	

* higher middle tip plus 0,4 mm

Available tip styles E-422

Material	Tip style	Plating	Further versions	
			ϕ	ϕ (inch)
2 01		A	$\phi 1,30$ (.051)	
3 07		A	$\phi 1,30$ (.051)	
2 09**		A	$\phi 0,80$ (.011)	
2 14		A	$\phi 1,30$ (.051)	2,00 (.079)
2 24***		A	$\phi 1,80$ (.071)	
2 33		A	$\phi 1,30$ (.051)	
2 91		A	$\phi 1,30$ (.051)	

** pressed-in steel point in base plunger made of brass

*** higher middle tip plus 0,5 mm

Ordering example

Series	Tip material	Tip style	Tip diameter (1/100 mm)	Plating	Spring force (dN)	Collar height
	2 = Steel 3 = BeCu			A = Gold N = Nickel		00 (E-100) 05 (E-422) tip- $\phi > 1,3$ mm 08 (E-422) recomb. for tip- $\phi < 1,3$ mm

Test probes:

E	1 0 0	2	9 1	0 0 0	A	3 0	0 0
E	4 2 2	2	1 4	2 0 0	A	3 0	0 5
E	4 2 2	2	9 1	1 3 0	A	3 0	0 8

DKS Rotating Probe

Test Probes for Challenging Contacting Demands

Grid:

≥ 1,27/1,91/2,54 mm

≥ 50/75/100 Mil

Installation height with KS: 16,0 mm (.630) / variable

Recommended stroke: 4,3 mm (.169)

Mounting and functional dimensions

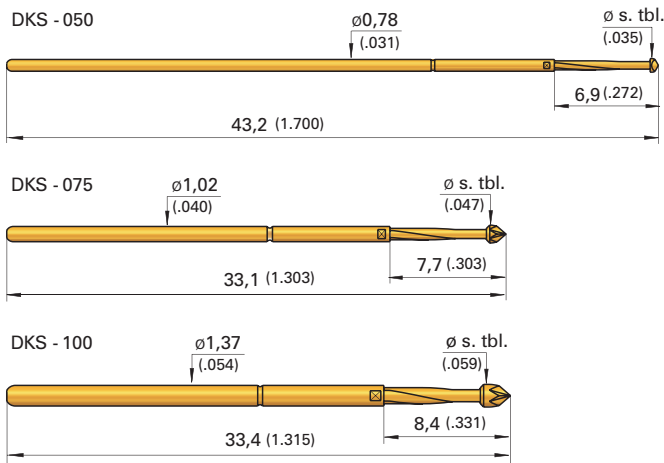

Collar height and installation height, receptacles, electrical data, mounting hole sizes and materials see compatible standard probe series: GKS-050/075/100.

DKS	Compatible probe	Page
DKS-050	GKS-050	25
DKS-075	GKS-075	26/27
DKS-100	GKS-100	28/29

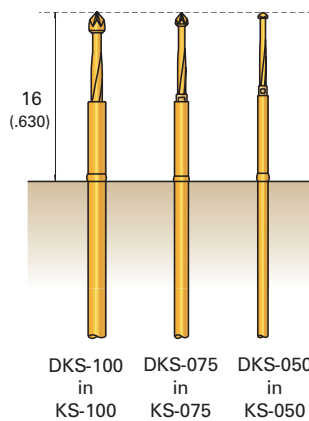

Mechanical data

Working stroke: 4,3 mm (.169)

Maximum stroke: 6,35 mm (.250)

Spring forces of DKS-050

Spring force at work. stroke: 1,5 N (5.4oz)

Alternative: 2,0 N (7.2oz)

Spring forces of DKS-075

Spring force at work. stroke: 1,0 N (3.6oz)

Alternative: 2,0 N (7.2oz)

Spring forces of DKS-100

Spring force at work. stroke: 1,0 N (3.6oz)

Alternative: 2,0 N (7.2oz) ; 3,0 N (10.8oz)

Materials

Plunger: BeCu or steel, gold-plated

Barrel: Nickel-silver or Bronze, gold-plated

Spring: Steel, gold-plated

Receptacle: Nickel-silver or brass, gold-plated

Operating temperature

Standard: -40° up to +80° C

Electrical data

Current rating:

DKS-050: 2 A

DKS-075: 3 A

DKS-100: 5 A

R_i typical: < 20 mΩ

Available tip styles DKS-050

Material	Tip style	Plating	Further versions	
			∅	∅ (inch)
2	07	G	∅ 0,90 (.035)	

Available tip styles DKS-075

Material	Tip style	Plating	Further versions	
			∅	∅ (inch)
3	07	G	∅ 0,76 (.026)	
2	17	G	∅ 1,20 (.047)	

Available tip styles DKS-100

Material	Tip style	Plating	Further versions	
			∅	∅ (inch)
3	07	G	∅ 1,00 (.039)	
2	17	G	∅ 1,50 (.059)	

Ordering example

Series	Tip material	Tip style	Tip diameter (1/100 mm)	Plating	Spring force (dN)	Collar height (mm)
	2 = Steel 3 = BeCu			G = Aurun		

Test probes:

D	K	S	0	5	0	2	0	7	0	9	0	G	1	5	0	0
D	K	S	0	7	5	2	1	7	1	2	0	G	2	0	0	0
D	K	S	1	0	0	2	1	7	1	5	0	G	2	0	0	0

Grid:
 ≥ 2,54 mm
 ≥ 100 Mil

Installation height with KS: 13,0 resp. 16,0 mm (.512 / .630)
Recommended stroke: 4,8 resp. 4,0 mm (.189 / .157)

Mounting and functional dimensions

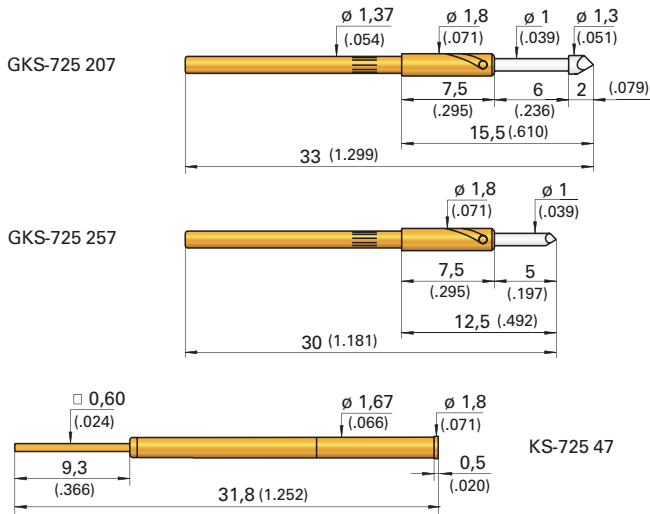

Available tip styles

Material	Tip style	Plating	Further versions	
			\varnothing	\varnothing (inch)
2 07		R	$\varnothing 1,30$ (.051)	
2 57*		R	$\varnothing 1,00$ (.039)	

*3 mm (.118) shorter

E-TYPE
DKS

Collar height and installation height

Tip style	Installation height with KS (inch)	Working stroke (inch)	Maximum stroke (inch)
07	16 mm (.630)	4,8 (189)	6,0 mm (.236)
57*	13 mm (.512)	4,0 (157)	5,0 mm (.197)

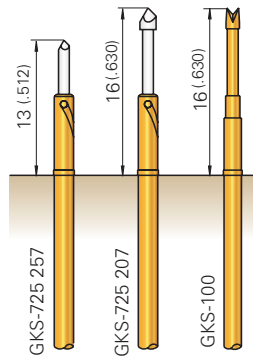

Mechanical data

Working stroke: see table above
Maximum stroke: see table above
Spring force at work. stroke: 1,5 N (5.4oz)

Materials

Plunger: Steel, rhodium-plated
Barrel: Brass, gold-plated
Spring: Steel, gold-plated
Receptacle: Brass, gold-plated

Note:

The knurl on the rotating test probe guarantees a secure fit in the receptacle or probe plate.

Electrical data

Current rating: 3 - 4 A
R_i typical: < 20 m Ω

Mounting hole size

in material CEM1 and FR4:
with receptacle: $\varnothing 1,67$ mm (.0657)
without receptacle: $\varnothing 1,37$ mm (.0539)

The KS-725 47 receptacle can be used with the standard GKS-100 test probe series (see assembly drawing).

Operating temperature

Standard: -40° up to +80° C

Ordering example

Series	Tip material 2 = Steel	Tip style	Tip diameter (1/100 mm)	Plating R = Rhodium	Spring force (dN)	Collar height (mm)	Type
--------	---------------------------	-----------	----------------------------	------------------------	----------------------	-----------------------	------

Test probe:

G K S 7 2 5 2 0 7 1 3 0 R 1 5 0 7 S

Receptacle:

K S - 7 2 5 4 7

GKS 713

Rotating Test Probe with Continuous Plunger

Grid:

≥ 4,50 mm

≥ 177 Mil

Installation height with KS: 13,2 resp. 18,2 mm (.520 / .717)

Recommended stroke: 4,0 mm (.157)

Mounting and functional dimensions

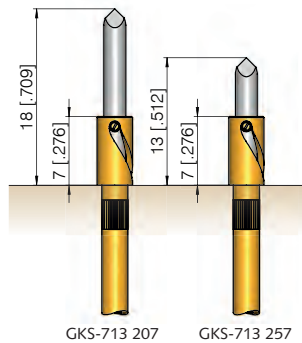
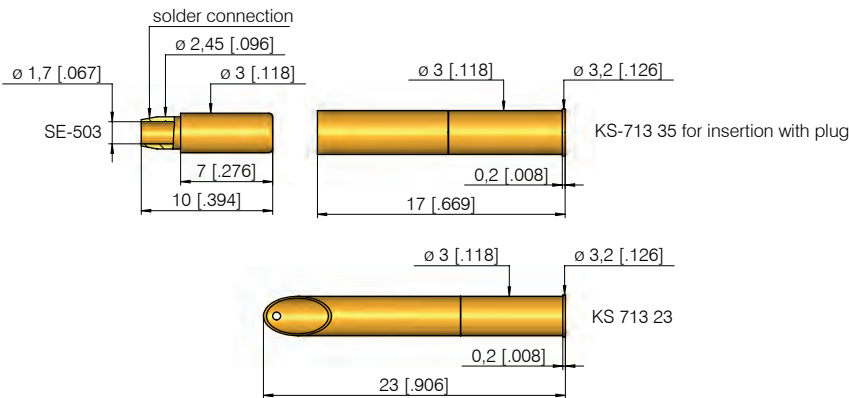
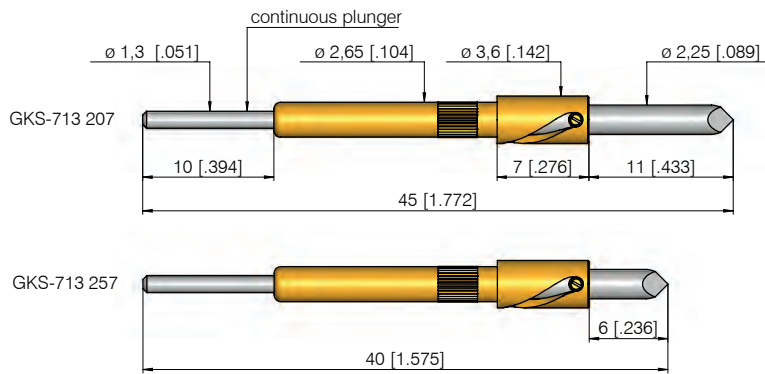

Collar height and installation height

GKS	Install. height with KS
713 206/207	18,2 mm (.717)
713 256/257	13,2 mm (.520)

Mechanical data

Working stroke: 4,0 mm (.157)

Maximum stroke: 5,0 mm (.197)

Spring force at work. stroke: 1,5 N (5.4oz)

Alternative: 3,0 N (10.8oz); 5,0 N (18.1oz)

Electrical data

Current rating, connection to KS: 5 - 8 A

Current rating, conn. to plunger: 8 A

R_i typical, connection to KS: < 30 mΩ

R_i typical, connection to plunger: < 10 mΩ

Operating temperature

Standard: -40° up to +80° C

Materials

Plunger: Steel, rhodium-plated

Barrel: Brass, gold-plated

Spring: Steel, gold-plated

Receptacle: Brass, gold-plated

Note:

The knurl on the rotating test probe guarantees a secure fit in the receptacle or probe plate.

Mounting hole size

with receptacle: ∅ 2,98 - 2,99 mm (.1173 - .1177)

without receptacle: ∅ 2,66 mm (.1047)

Ordering example

Series	Tip material 2 = Steel	Tip style	Tip diameter (1/100 mm)	Plating R = Rhodium	Spring force (dN)	Collar height (mm)
--------	---------------------------	-----------	----------------------------	------------------------	----------------------	-----------------------

Test probe:

G K S 7 1 3 2 0 6 2 2 5 R 1 5 0 7

Receptacle:

K S - 7 1 3 2 3 K S - 7 1 3 3 5

Lamellar plug:

S E - 5 0 3

(for plugging onto the end of the plunger)

Available tip styles

Material	Tip style	Plating	Further versions	
			∅	∅ (inch)
2 06		R	4,00	R
2 07		R		
2 56*		R		
2 57*		R		

* 5 mm (.197) shorter

Bead Probe Flying Probe

Bead probes are used to contact small solder beads directly on PCB tracks or micro-vias (bead probe technology). To ensure optimal contact with the various bead geometries, configurations, and surfaces, the largest selection of tip styles on the market is available from INGUN.

INGUN bead probe test probes are 100% compatible with the standard GKS-050/075/100/135 series.



The **tip-style 02** – flat - is preferably used for flux-free and/or small beads.

The **tip-style 60** – fine-serrated – is recommended (due to the fine, aggressive points) for breaking open the surfaces of the beads, which are coated with flux-deposits.

The **multi-blade tip style 79** (star) is recommended for long, narrow, or large beads with solder flux deposits thanks to the self-cleaning horizontal cutting edge.

Flying test probes are used in flying probe systems. Maximum precision and contacting accuracy is achieved by the geometry of the barrel, as well as the specialised beading, which enables contacting in 0.15 mm grids. INGUN recommends the GKS-112 MD series for use in the flying probe system from Scorpion/Acculogic and Digital-test.

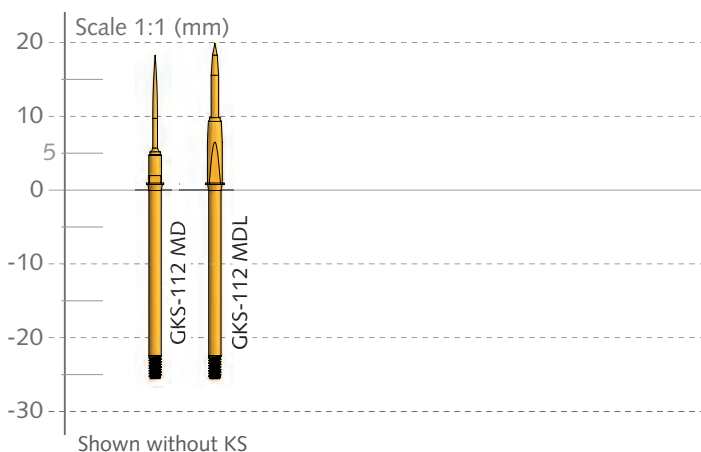

Bead Probe

GKS-050	48
GKS-075	48
GKS-100	48
GKS-135	48
GKS-550	48

Flying Probe

GKS-112 MD	49
------------	----

Note:

See page 22 for overview and comparison table.

GKS 050/075/100/135/550

ICT-/FCT Test Probes
for Bead Probes Contacting

Grid:

≥ 1,27 / 1,91 / 2,54 mm

≥ 50 / 75 / 100 Mil

Installation height with KS: 16 mm (.630) / variable

Recommended stroke: 4,3 mm (.169)

Mounting and functional dimensions

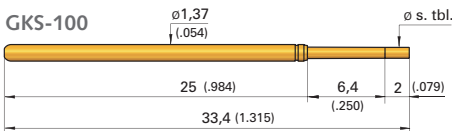
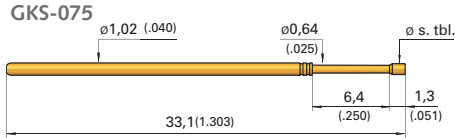
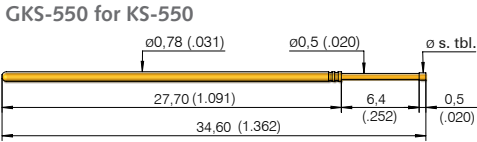
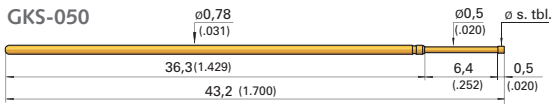

Long-stroke test probe for dual-stage fixtures

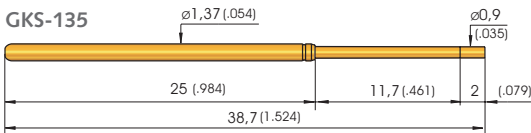

Available tip styles GKS-050/550			
Material	Style	Ø (inch)	Plating
3	02	Ø 0,60 (.024)	A
3	60	Ø 0,50 (.020)	A

Available tip styles GKS-050/550			
Material	Tip style	Ø (inch)	Plating
3	60 Distance between points: 0,20 mm	Ø 0,60 (.024)	A
3	60 Distance between points: 0,25 mm	Ø 0,90 (.035)	A
3	79	Ø 0,50 (.020)	A

Available tip styles GKS-075			
Material	Style	Ø (inch)	Plating
3	02	Ø 0,90 (.035)	A
3	60 Distance between points: 0,20 mm	Ø 0,64 (.025)	A

Available tip styles GKS-075			
Material	Tip style	Ø (inch)	Plating
3	60 Distance between points: 0,20 mm	Ø 0,90 (.035)	A
3	79	Ø 0,64 (.025)	A

Available tip styles GKS-100			
Material	Style	Ø (inch)	Plating
3	02	Ø 0,90 (.035)	A
3	02	Ø 1,50 (.060)	A
3	60 Distance between points: 0,20 mm	Ø 0,64 (.025)	A

Available tip styles GKS-100			
Material	Tip style	Ø (inch)	Plating
3	60 Distance between points: 0,20 mm	Ø 0,90 (.035)	A
3	79	Ø 0,64 (.025)	A
3	79	Ø 0,90 (.035)	A

Available tip styles GKS-135			
Material	Style	Ø (inch)	Plating
3	02	Ø 0,90 (.035)	A
3	60 Distance between points: 0,20 mm	Ø 0,90 (.035)	A

Mechanical data

Work. stroke: 050/075/100/550 4,3 mm (.169)

Max. stroke: 050/075/100/550 6,35 mm (.250)

Work. stroke: 135 9,3 mm (.366)

Max. stroke: 135 11,5 mm (.453)

Spring force of GKS-050/550:

Spring force at work. stroke: 1,5 N (5.4oz)

Alternative: 1,0 N (3.6oz); 2,0 N (7.2oz) (not for GKS-550)

Spring force of GKS-075:

Spring force at work. stroke: 1,5 N (5.4oz)

Alternative: 1,0 N (3.6oz); 2,0 N (7.2oz); 2,8 N (10.1oz)

Materials

Plunger: BeCu, gold-plated

Barrel: Nickel-silver or Bronze, gold-plated

Spring: Steel, gold-plated

Receptacle: Nickel-silver or brass, gold-plated

Spring force of GKS-100:

Spring force at work. stroke: 1,5 N (3.6oz)

Alternative: 2,0 N (7.2oz); 3,0 N (10.8oz)

Spring force of GKS-135:

Spring force at work. stroke: 1,5 N (5.4oz)

Alternative: 2,0 N (7.2oz); 3,0 N (10.8oz)

Operating temperature

Standard: -40° up to +80° C

Note:

Collar height and installation height, receptacles, electrical data, mounting hole size: see compatible standard probe series.

Ordering example

Test probes:

Series	Tip material 3 = BeCu	Tip style	Tip diameter (1/100 mm)	Plating A = Gold N = Nickel	Spring force (dN)	Collar height (mm)	
G K S	0 5 0	3	6 0	0 6 0	A	1 5	0 0
G K S	5 5 0	3	6 0	0 6 0	A	1 5	0 0
G K S	0 7 5	3	6 0	0 9 0	A	2 0	0 0
G K S	1 0 0	3	6 0	0 9 0	A	2 0	0 0
G K S	1 3 5	3	6 0	0 9 0	A	2 0	0 0

Grid:
≥ 2,54 mm
≥ 100 Mil

Installation height with KS: 14,7 - 21,6 mm (.579 - .850)
Recommended stroke: 4,0 mm (.157)

Mounting and functional dimensions

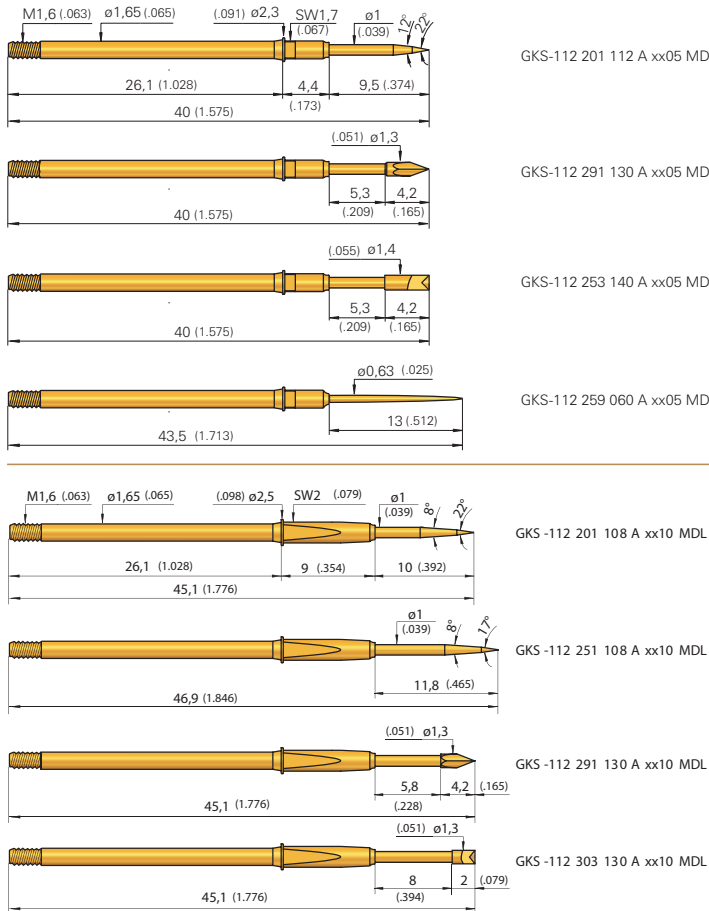

Type	Oper. stroke in mm (inch)	Max. stroke in mm (inch)	Inst.-height with KS in mm (inch)
01...05 MD	4,0 (.157)	8,0 (.315)	14,7 (.579)
91...05 MD	4,0 (.157)	5,3 (.209)	14,7 (.579)
53...05 MD	4,0 (.157)	5,3 (.209)	14,7 (.579)
59...05 MD	4,0 (.157)	8,0 (.315)	18,2 (.717)
01...10 MDL	4,0 (.157)	8,0 (.315)	19,8 (.780)
51...10 MDL	4,0 (.157)	8,0 (.315)	21,6 (.850)
91...10 MDL	4,0 (.157)	5,8 (.256)	19,8 (.780)
03...10 MDL	4,0 (.157)	8,0 (.315)	19,8 (.780)

Materials
Plunger: Steel or BeCu, gold-plated
Barrel: Brass, gold-plated
Spring: Steel, gold-plated
Receptacle: Brass, gold-plated

Mechanical data
Spring force at work. stroke: 1,5 N (5.4oz)
Alternative: 0,6 (2.2oz); 0,8 (2.9oz); 2,25 (8.1oz); 3,0 N (10.8oz)

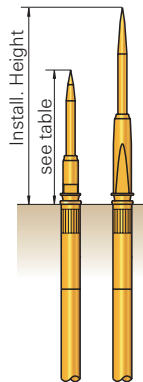

Available tip styles version GKS-112 ... 05 MD

Material	Tip style	Plating	Further versions	
			∅	∅ (inch)
2 01		A	∅ 1,12 (.044)	
2 91		A	∅ 1,30 (.051)	
2 53		A	∅ 1,40 (.055)	
2 59		A	∅ 0,60 (.024)	

Available tip styles version GKS-112 ... 10 MDL

Material	Tip style	Plating	Further versions	
			∅	∅ (inch)
2 01		A	∅ 1,08 (.043)	
2 51		A	∅ 1,08 (.043)	
2 91		A	∅ 1,30 (.051)	
3 03		A	∅ 1,30 (.051)	

Note:
 GKS-112 ... MD and MDL is screwed in KS-112 ... M, shown on page 125.
 Recommended screw-in torque:
 Min.: 3 cNm / Max.: 5 cNm

Electrical data
Current rating: 5 - 8 A
R_i typical: < 20 mΩ

Operating temperature
Standard: -40° up to +80° C

Mounting hole size
for KS-112 xx M and KS-112 xx M-T in CEM1 and FR4: ∅ 1,98 - 1,99 mm (.0780 - .0783)
for KS-112 xx M-R in CEM1 and FR4: ∅ 2,00 - 2,02 mm (.0787 - .0795)

Ordering example

Series	Tip material	Tip style	Tip diameter	Plating	Spring force	Collar height	Special designation alternative
	2 = Steel 3 = BeCu		(1/100 mm)	A = Gold	(dN)	(mm)	"MDL"

Test probe:

G K S 1 1 2 2 0 1 1 1 2 A 1 5 0 5 M D

Receptacles (shown on page 125):

K S - 1 1 2 3 0 M - T K S - 1 1 2 3 0 M - R

Receptacles for leakage test (shown on page 125):

K S - 1 1 2 3 0 M

Screw-in tool for GKS-112 ... 05 MD:

B I T - G K S 1 1 2 M - B

Screw-in tool for GKS-112 ... 10 MDL:

B I T - G K S 1 1 2 M - B - F P

Sealed with **EXCELLENCE.**

INGUN develops and produces **test fixtures** for all commonly used test systems: **standard test fixtures** and **specialised customising** tailored to your individual test requirements.



Manual test fixtures:

- MA xxx series: For laboratory and low PCB volumes
- MA 21xx series: ICT/FCT test for mixed PCB volumes
- MA 32xx series: ICT/FCT test for high PCB volumes
- Designed as individual fixture or interchangeable kit
- Contact force up to 2000 N
- Modular system with large range of additional functions
- Available for all commonly used test systems

Manual
Test Fixtures

www.ingun.com

Fine Pitch

Fine pitch test probes are used for test points positioned close together, which cannot be contacted by standard test probes. These test probes can be used either with or without a receptacle.

Test probes used with receptacles are changed from top side in the usual way, without breaking the electrical connection. In order to avoid elaborate wiring of the receptacle, use of pre-wired receptacles is preferred.

Test probes with a plug connection can be used without a receptacle to enable them to also be used for small grids. The plug is usually pressed or glued into the plug mounting plate. The probes have a floating mount in the probe plate and are centred and secured by means of a holding guide plate. This type of customising has the following advantages:

- Contacting of very small pads (can be used in grids smaller than probes with receptacles)
- High contacting accuracy due to low 'wobble' of the test probe in the holding guide plate
- Sandwich assembly of test fixture possible
- Larger drilling tolerances permitted in the probe plate

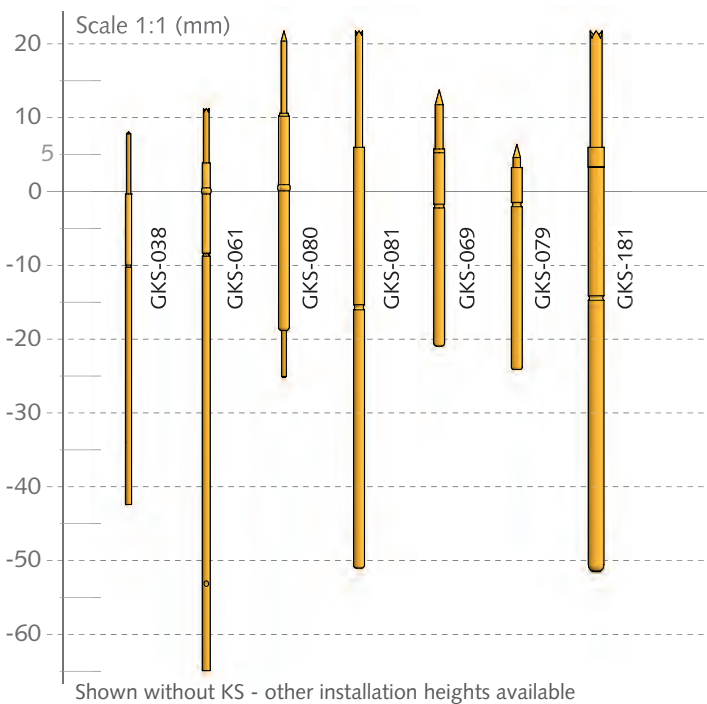

Fine Pitch

GKS-038	52
GKS-061	52
GKS-080	53
GKS-081	54
GKS-069	55
GKS-079	56
GKS-181	57

Note:
See page 22 for overview and comparison table.

GKS 038 / GKS 061

Micro-contacting

Grid:

≥ 0,64 mm

≥ 25 Mil

Installation height: 4,0 mm (.157)

Recommended stroke: 2,0 mm (.079)

Mounting and functional dimensions

GKS 038

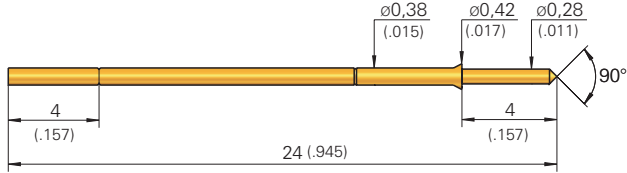

pre-wired version with enamelled copper wire \varnothing 0,22 mm: see example below

Available tip styles

Material	Tip style	Plating	Further versions	
			\varnothing	\varnothing (inch)
3 02		A		
3 08		A		

GKS 061

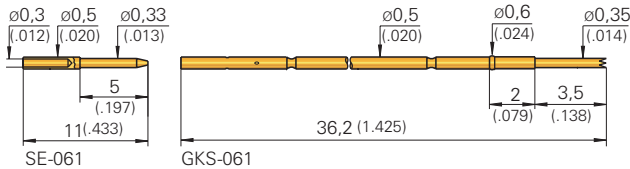

Grid:

≥ 0,8 mm

≥ 30 Mil

Installation height: 5,5 mm (.217)

Recommended stroke: 2,5 mm (.098)

Available tip styles

Material	Tip style	Plating	Further versions	
			\varnothing	\varnothing (inch)
3 04		A		

Mechanical data	GKS 038	GKS 061
Working stroke:	2,0 mm (.079)	2,5 mm (.098)
Maximum stroke:	2,5 mm (.098)	3,5 mm (.138)
Spring force at work.stroke:	0,4 N (1.4oz)	0,6 N (2.2oz)

Electrical data	GKS 038	GKS 061
Current rating:	1 A	2 A
R_i typical:	< 100 m Ω	< 50 m Ω

Operating temperature	GKS 038	GKS 061
Standard:	-40° up to +80° C	-40° up to +80° C

Mounting hole size	GKS 038	GKS 061
	\varnothing 0,37 - 0,39 mm (.0146 - .0154)	\varnothing 0,5 mm (.197)

Materials	
Plunger:	BeCu, gold-plated
Barrel:	Bronze, gold-plated
Spring:	Steel, gold-plated
Plug:	Brass, gold-plated

Note:

This test probe is available pre-wired with 1 m wire AWG 34: see ordering example. Recommended minimal bending radius: 10 mm (.394).

Ordering example

	Series	Tip material 3 = BeCu	Tip style	Tip diameter (1/100 mm)	Plating A = Gold	Spring force (dN)	Collar height (mm)	Special designation
Test probe:	G K S	0 3 8	3	0 8	0 2 8	A	0 4	0 0
Test probe (pre-wired with AWG 34):	G K S	0 3 8	3	0 8	0 2 8	A	0 4	0 0 V
Test probe:	G K S	0 6 1	3	0 4	0 3 5	A	0 6	0 2
Plugs for direct connection to GKS:	S E	-	0 6 1					

Grid:
 ≥ 1,00 mm
 ≥ 40 Mil

Installation height with KS: 10,5 mm (.413)
Recommended stroke: 3,0 mm (.118)

Mounting and functional dimensions

without receptacle

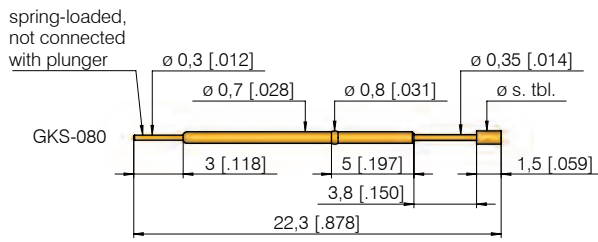

with receptacle

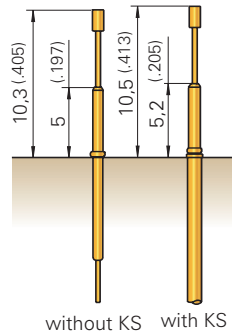
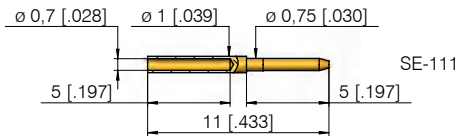
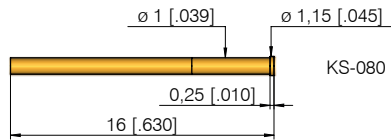
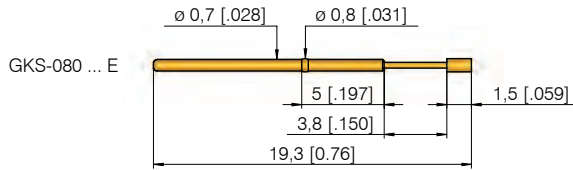

Collar height and installation height

The installation height of the tip (dimension without KS) is defined by the collar height of the test probe.

Collar height: 05
 Installation height: 10,3 mm (.405)
 (without receptacle)

Mechanical data

Working stroke: 3,0 mm (.118)
Maximum stroke: 3,8 mm (.150)
Spring force at work. stroke: 0,8 N (2.9oz)

Electrical data

Current rating: 3 A
R_i typical: < 20 mΩ

Operating temperature

Standard: -40° up to +80° C

Materials

Plunger: BeCu, gold-plated
Barrel: Brass, gold-plated
Spring: Steel, gold-plated
Receptacle: Brass, gold-plated

Mounting hole size

with receptacle:
 in CEM1: ∅ 0,98 - 1,00 mm (.0386 - .0394)
 in FR4: ∅ 0,99 - 1,00 mm (.0390 - .0394)
without receptacle:
 in CEM1 and FR4: ∅ 0,70 mm (.0276)

		Available tip styles		
Material	Tip style	Plating	Further versions	
			∅	∅ (inch)
3	01	A	∅ 0,35 (.014)	
3	02	A	∅ 0,80 (.031)	
3	03	A	∅ 0,80 (.031)	
3	04	A	∅ 0,80 (.031)	0,50 (.020)
3	05	A	∅ 0,80 (.031)	
3	08	A	∅ 0,80 (.031)	

Fine Pitch

Note:
 When using receptacles choose probe version GKS-080 ... E (version without solder cup).
 The receptacle can be used from grid size 1,27 mm (50 Mil) upward.

Ordering example

Series	Tip material 3 = BeCu	Tip style	Tip diameter (1/100 mm)	Plating A = Gold	Spring force (dN)	Collar height (mm)	Special designation ("E")
Test probe:	G K S	0 8 0	3	0 1	0 3 5	A	0 8 0 5
Receptacle:	K S - 0 8 0						
Plug for receptacle:	S E - 1 1 1						

GKS 081

Test Probe for Contacting in SMD-Technology

Grid:

≥ 1,00 mm

≥ 40 Mil

Installation height: 10,5/13,0/16,0 mm (.413/ .512/ .630)

Recommended stroke: 5,5 mm (.217)

Mounting and functional dimensions

without receptacle

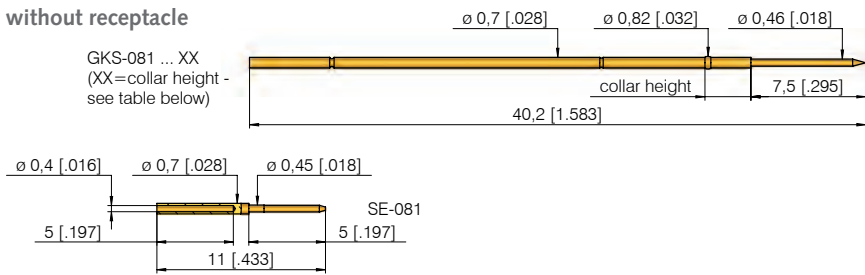

with receptacle

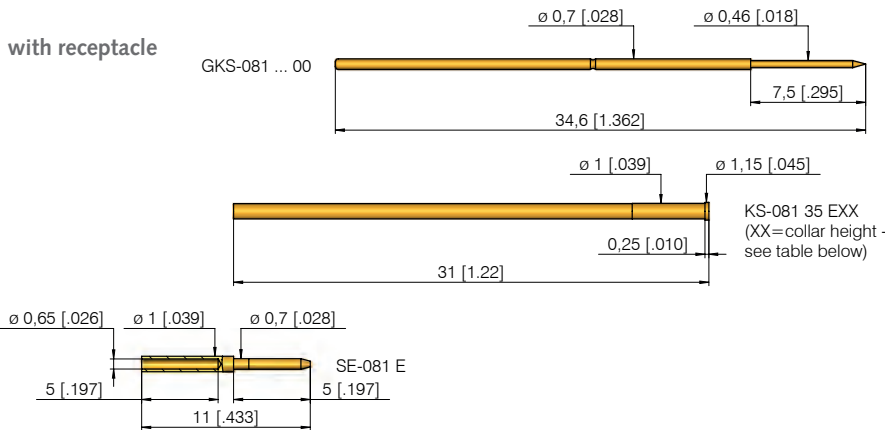

Collar height and installation height

To adjust the installation height, test probes and receptacles with various collar heights are available.

Collar height	Installation height
03	10,5 mm (.413)
05	13,0 mm (.512)
08	16,0 mm (.630)

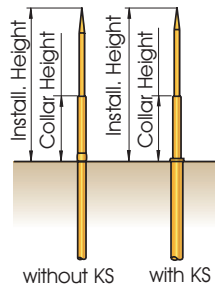

Mechanical data

Working stroke: 5,5 mm (.217)

Maximum stroke: 7,5 mm (.295)

Spring force at work. stroke: 0,8 N (2.9oz)

Electrical data

Current rating: 3 A

R_i typical: < 30 mΩ

Operating temperature

Standard: -40° up to +80° C

Materials

Plunger: BeCu or steel, gold-plated

Barrel: Brass, gold-plated

Spring: Steel, gold-plated

Receptacle: Brass, gold-plated

Mounting hole size

with receptacle: ∅ 0,98 - 0,99 mm (.0386 - .0390)

without receptacle: ∅ 0,70 - 0,71 mm (.0276 - .0280)

Note:

The receptacle can be used from grid size 1,27 mm (50 Mil) upward.

Available tip styles

Material	Tip style	Plating	Further versions	
			∅	∅ (inch)
3 51		∅ 0,50 (.020)	A	
3 54		∅ 0,50 (.020)	A	
2 91		∅ 0,50 (.020)	A	

Ordering example

Series	Tip material 2 = Steel 3 = BeCu	Tip style	Tip diameter (1/100 mm)	Plating A = Gold	Spring force (dN)	Collar height (mm)
--------	---------------------------------------	-----------	----------------------------	---------------------	----------------------	-----------------------

Test probe for use **without** receptacle:

G K S 0 8 1 3 5 4 0 5 0 A 0 8 0 3

Test probe for use **with** receptacle:

G K S 0 8 1 3 5 4 0 5 0 A 0 8 0 0

Receptacles:

K S - 0 8 1 3 5 E 0 3 K S - 0 8 1 3 5 E 0 5 K S - 0 8 1 3 5 E 0 8

Plug for direct connection to probe (GKS):

S E - 0 8 1

Plug for receptacle:

S E - 0 8 1 E

Grid:
 ≥ 1,27 mm
 ≥ 50 Mil

Installation height with KS: 6,7 mm (.264) / 6,3 mm (.248)/variable
Recommended stroke: 2,2 mm (.087)

Mounting and functional dimensions

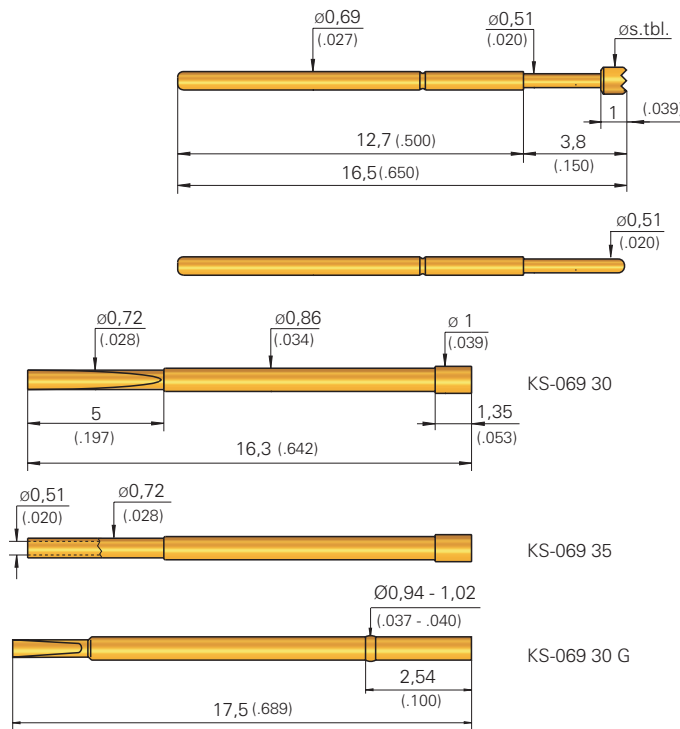

Collar height and installation height

The installation height of the probe is determined by the receptacle.

Designation	Install. height with KS
KS-069 30	6,7 mm (.264)
KS-069 35	6,7 mm (.264)
KS-069 30 G	6,3 mm (.248)/variable

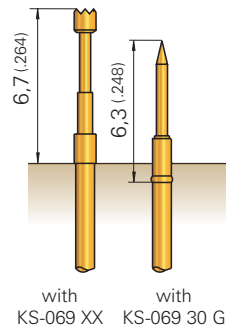

Mechanical data

Working stroke: 2,2 mm (.087)
Maximum stroke: 2,8 mm (.110)
Spring force at work. stroke: 0,7 N (2.5oz)
Alternative: 1,0 N (3.6oz)

Electrical data

Current rating: 3 A
R_i typical: < 20 mΩ

Operating temperature

Standard: -40° up to +80° C

Materials

Plunger: BeCu or steel, gold-plated or chemically nickel-plated
Barrel: Nickel-silver, gold-plated
Spring: Steel, gold-plated
Receptacle: Brass or Nickel-silver, gold-plated

Mounting hole size

for KS-069 30 / 35: \varnothing 0,85 - 0,86 mm (.0335 - .0339)
for KS-069 30 G: \varnothing 0,86 - 0,92 mm (.0339 - .0362)

Note:

Series 069 can only be used with a receptacle.

The KS-069 is available pre-wired with 1 m wire AWG 26 (see ordering example). Recommended minimal bending radius: 10 mm (.394).

Note:

Test probes in the GKS-069 series are also available with bent barrel end (special designation "B")

		Available tip styles			
Material	Tip style	Plating	Further versions		
			\varnothing	\varnothing (inch)	
2 01		N	0,51 A	(.020)	
3 03		A	1,52	(.060)	
2 05		N			
3 05		A			
3 05		A			
3 06		A			
3 07		A			
2 14		A			
2 17		A			

Fine Pitch

Ordering example

Series	Tip material 2 = Steel 3 = BeCu	Tip style	Tip diameter (1/100 mm)	Plating A = Gold N = Nickel	Spring force (dN)	Collar height (mm)	Special designation ("B")
--------	---------------------------------------	-----------	----------------------------	-----------------------------------	----------------------	-----------------------	--------------------------------

Test probe:

G K S 0 6 9 3 0 6 0 9 0 A 0 7 0 0

Receptacles:

K S - 0 6 9 3 0 K S - 0 6 9 3 5 K S - 0 6 9 3 0 G

Receptacle, pre-wired with AWG 26:

K S - 0 6 9 3 5 V - 2 6

GKS 079

Short-Stroke Test Probe

Grid:

≥ 1,27 mm

≥ 50 Mil

Installation height with KS: 3,2 mm (.126)

Recommended stroke: 1,0 mm (.039)

Mounting and functional dimensions

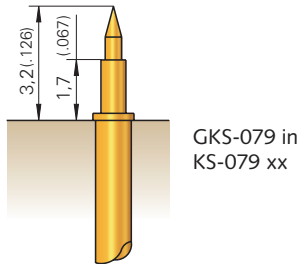
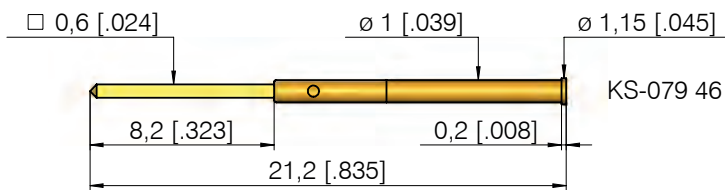
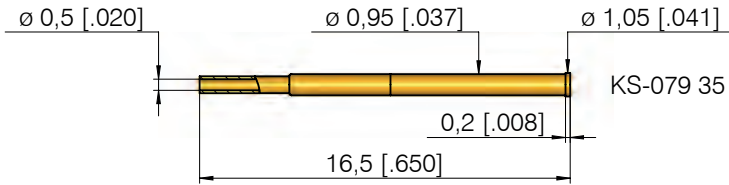
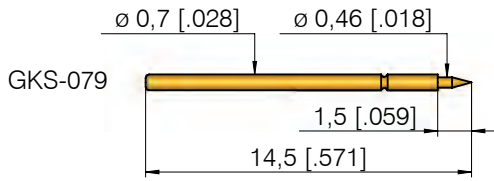

Collar height and installation height
The installation height with KS-079 is: 3,2 mm (.126)

Available tip styles

Material	Tip style	Plating	Further versions	
			Ø	Ø (inch)
ω 01	Ø 0,50 (.020)	A		

Mechanical data

Working stroke: 1,0 mm (.039)
Maximum stroke: 1,2 mm (.047)
Spring force at work. stroke: 1,3 N (4.7oz)

Materials

Plunger: BeCu, gold-plated
Barrel: Bronze, gold-plated
Spring: Steel, gold-plated
Receptacle: Brass, gold-plated

Note:

The KS-079 is available pre-wired with 1 m wire AWG 26 (see ordering example). Recommended minimal bending radius: 10 mm (.394).

Electrical data

Current rating: 3 A
R_i typical: < 20 mΩ

Mounting hole size

KS-079 35
in CEM1 and FR4: ø 0,94 - 0,95 mm (.0370 - .0374)
KS-079 46
in CEM1 and FR4: ø 1,01 - 1,02 mm (.0400 - .0400)

Operating temperature

Standard: -40° up to +80° C

Ordering example

Series	Tip material 3 = BeCu	Tip style	Tip diameter (1/100 mm)	Plating A = Gold	Spring force (dN)	Collar height (mm)
--------	--------------------------	-----------	----------------------------	---------------------	----------------------	-----------------------

Test probe:

G K S 0 7 9 3 0 1 0 5 0 A 1 3 0 0

Receptacle:

K S - 0 7 9 3 5

Receptacle with wire-wrap:

K S - 0 7 9 4 6

Receptacle, pre-wired with AWG 26:

K S - 0 7 9 3 5 V - 2 6

Grid:

≥ 1,27 mm

≥ 50 Mil

Installation height: 10,5/13,0/16,0 mm (.413/ .512/ .630)

Recommended stroke: 5,5 mm (.217)

Mounting and functional dimensions

without receptacle

GKS-181 ... XX
(XX=collar height -
see table below)

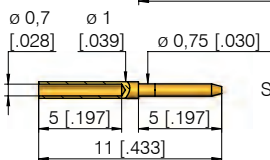
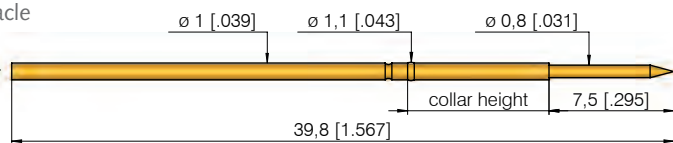

with receptacle

GKS-181 ... 00

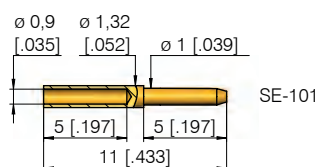
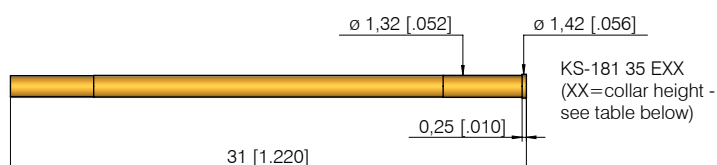
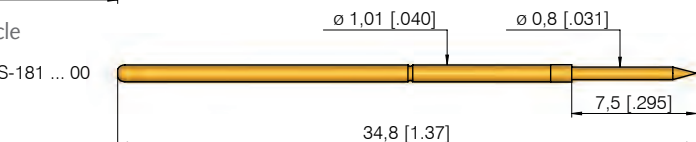

Collar height and installation height

To adjust the installation height, test probes and receptacles with various collar heights are available.

Collar height	Installation height
03	10,5 mm (.413)
05	13,0 mm (.512)
08	16,0 mm (.630)

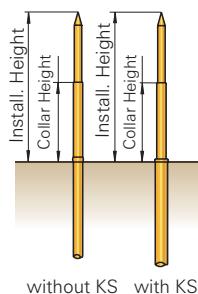

Mechanical data

Working stroke: 5,5 mm (.217)
Maximum stroke: 7,5 mm (.295)
Spring force at work. stroke: 1,5 N (5.4oz)
Alternative: 0,8 N (2.9oz)

Electrical data

Current rating: 2 - 3 A
R_i typical: < 20 mΩ

Operating temperature

Standard: -40° up to +80° C

Materials

Plunger: BeCu or steel, gold-plated or chemically nickel-plated
Barrel: Brass, gold-plated
Spring: Steel, gold-plated
Receptacle: Brass, gold-plated

Mounting hole size

with receptacle: ∅ 1,31 - 1,32 mm (.0516 - .0520)
without receptacle: ∅ 1,00 mm (.0394)

Note:

The receptacle can be used from grid size 1,91 mm (75 Mil) upwards.

Ordering example

Series	Tip material 2 = Steel 3 = BeCu	Tip style	Tip diameter (1/100 mm)	Plating A = Gold N = Nickel	Spring force (dN)	Collar height (mm)
--------	---------------------------------------	-----------	----------------------------	-----------------------------------	----------------------	-----------------------

Test probe for use **without** receptacle:

G K S 1 8 1 3 5 1 0 8 0 A 1 5 0 3

Test probe for use **with** receptacle:

G K S 1 8 1 3 5 1 0 8 0 A 1 5 0 0

Receptacles:

K S - 1 8 1 3 5 E 03 K S - 1 8 1 3 5 E 05 K S - 1 8 1 3 5 E 08

Plug for Direct Connection on to GKS:

S E - 1 1 1

Plug for receptacle:

S E - 1 0 1

		Available tip styles		
Material	Tip style	Plating	Further versions	
			∅	∅ (inch)
3	05	A	∅ 0,80 (.031)	
3	51	A	∅ 0,80 (.031)	
3	54	A	∅ 0,80 (.031)	
2	91	N	∅ 0,80 (.031)	

Sealed with **EXCELLENCE.**

Contacting solutions up to 400 A for every industry and application. The **high current probes** from INGUN guarantee secure transmission of high currents. In addition, they enable precise measurements with limited warming and low internal resistance.

INGUN offers an unbeatable range of products:

- Standard high current probes
- Short stroke and long stroke
- Dipole high current probes
- Robust high current probes



High Current
Test Probes

www.ingun.com

Metric Standards Test Probe (GKS with Collar)

Metric standards test probes stand out due to their high degree of stability as well as their robustness and all feature a pronounced collar (stop).

The collar is available in various heights, depending on the series and the receptacle combination allows maximum installation height flexibility.

In addition to the classic ICT/FCT applications, the metric series also covers many specialised applications. Test probes with continuous plungers can be used for higher currents or precise measurements due to their low resistance.

Furthermore, short versions when installation space is limited, and long versions for dual stage contacting are available. Versions with beading in the middle of the barrel are used to contact small pads, because of their low 'wobble'.

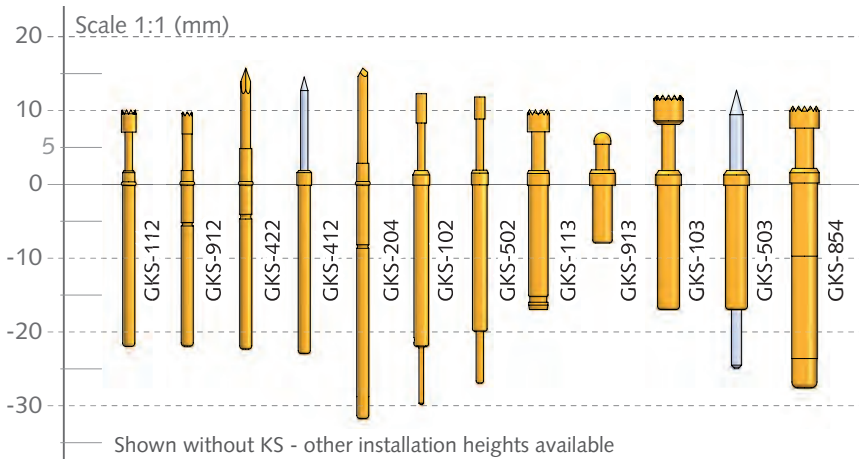

Metric Standard

GKS-112	61
GKS-912	62
GKS-422	63
GKS-412	64
GKS-204	65
GKS-102	66
GKS-502	67
GKS-113	68
GKS-913	69
GKS-103	70
GKS-503	71
GKS-854	72

Note:

See page 22 for overview and comparison table.

Receptacles in the KS-112 series are available with different collar heights, making variable installation heights possible. *The number of variations can be increased by using spacers., which may, however, reduce the test probe's holding force in the receptacle. In such cases, test probes with bent ends (end designation "B" = banana-shaped) should be used. The receptacles KS-112 47... (with wire-wrap post) are sufficiently vacuum-sealed for use in vacuum fixtures.

Receptacles with solder terminal		
Order No.:	Receptacle Type	Collar height in mm (inches)
KS-112 23		0,2 (.008)
KS-112 30		0,2 (.008)
KS-112 30 E2		2 (.079)
KS-112 30 E5		5 (.179)

Receptacles with plug connection		
KS-112 35 with SE-101		0,2 (.079)

Receptacles with press ring		
KS-112 30 G8		1 ... 8 (.039... .315)
KS-112 47 G8		8 (.039... .315)

Vacuum-sealed receptacles with wire-wrap-posts		
KS-112 47		0,2 (.008)
KS-112 47 15		0,2 (.008)
KS-112 47 E2/E5		2/5 (.079 / .197)

* Spacers to vary the installation height				
DS-112-01	DS-112 01	DS-112 02	DS-112 03	DS-112 05

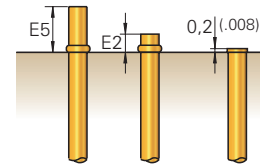

Example for use of KS-112 with various collar heights

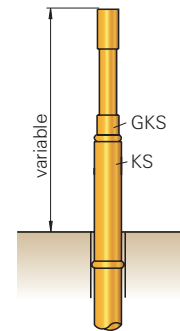

Example for use of KS-112 ... G8 (with press ring)

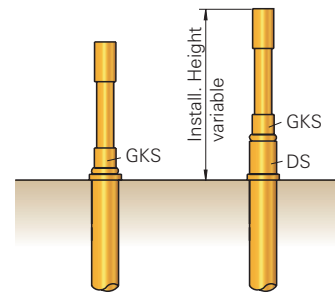

* Example of use of a receptacle with and without spacer (restrictions see above)

Mounting hole size

for KS with collar:

CEM1: \varnothing 1,98 - 2,00 mm (.0780 - .0787)

FR4: \varnothing 1,99 - 2,01 mm (.0783 - .0791)

Material

for KS with collar:

Brass or nickel-silver, gold-plated

Mounting hole size

for KS with press ring (press ring pressed in mounting hole)

CEM1 and FR4: \varnothing 2,03 - 2,05 mm (.0799 - .0807)

Material

for KS with press ring:
 Bronze, gold-plated

Receptacles:

KS - 1 1 2 3 0

KS - 1 1 2 4 7

Spacers:

DS - 1 1 2 0 2

DS - 1 1 2 0 5

Insertion tools for all receptacles:

SW KS - 1 1 2

Grid:
 ≥ 2,54 mm
 ≥ 100 Mil

Installation height with KS: 10,5 - 26,3 mm (.413 - 1.035) / variable
Recommended stroke: 4,0 mm (.157)

Mounting and functional dimensions

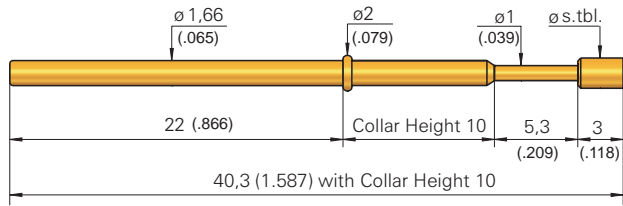

Plug

VS-112 is used instead of a test probe to prevent receptacles being used unnecessarily during maintenance.

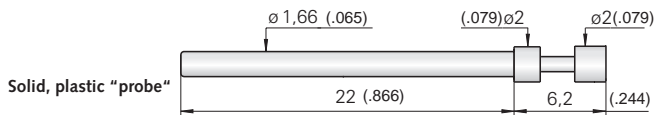

Collar height and installation height

Test probes with alternative collar heights are available to adjust the installation height of the tip (dimension without receptacle).

Collar height	Installation height without receptacle
02	10,3 mm (.406)
03	11,3 mm (.445)
04	12,3 mm (.484)
05	13,3 mm (.524)
06	14,3 mm (.563)
07	15,3 mm (.602)
08	16,3 mm (.642)
09	17,3 mm (.681)
10	18,3 mm (.720)

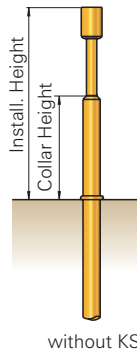

without KS

Mechanical data

Working stroke: 4,0 mm (.157)
Maximum stroke: 5,3 mm (.209)
Spring force at work. stroke: 1,5 N (5.4oz)
Alternative: 0,6 N (2.2oz); 0,8 N (2.9oz); 2,25 N (8.1oz); 3,0 N (10.8oz); 5,0 N (18.1oz)

Test probes with tip diameter ≤ 1,0 mm (.039) have a maximum stroke of 8,0 mm (.315)
 Exception: 5,0 N-spring (18.1oz): max. stroke is always 5,3 mm (.209).

Materials

Plunger: BeCu or steel, gold-plated, rhodium- or chemically nickel-plated
Barrel: Nickel-silver or brass, gold-plated
Spring: Steel, gold-plated, stainless steel*(C)
Receptacle: Brass, gold-plated

Operating temperature

Standard: -40° up to +80° C
***with spec. designation "C":** -100° up to +200° C (0,8 N ; 1,5 N; 2,25 N; 3,0 N)

Electrical data

Current rating: 5 - 8 A
R_j typical: < 20 mΩ (* < 100 mΩ)

Material	Tip style	Plating	Further versions	
			∅	∅ (inch)
2	01	R A	0,80	(.031)
3	02	A		
3	02	A	1,00 1,50	(.039) (.059)
3	03	A	1,40 1,80	(.055) (.071)
2	04	R	1,30	(.051)
3	05	A	0,80	(.031)
3	05	A	1,00 1,40 2,30	(.039) (.055) (.091)
0	06**	A		
3	06	A		
3	06	R	1,30 R 1,50 R 1,80 R 2,50 R	(.051) (.059) (.071) (.098)
2	07	R A	1,30 A	(.051)
2	09***	N		
2	14	A	1,30 R	(.051)
2	17	N	2,00 R	(.079)
3	19	A	2,00 A	(.079)

** also available as tip style 0 02 and 0 03, installation height plus 0,8 mm (.031)

*** pressed-in steel point in base plunger made of brass

Note to GKS-112 and KS-112:
 Receptacles in the KS-112 series are used for the GKS-112 test probe series.

Note:
 Screw-in versions shown on page 125.

Ordering example

Series	Tip material	Tip style	Tip diameter (1/100 mm)	Plating	Spring force (dN)	Collar height (mm)	Special designation ("C")
0 = Delrin	2 = Steel			N = Nickel			
3 = BeCu				R = Rhodium			

Test probe:

G K S 1 1 2 2 0 4 1 3 0 R 1 5 0 2

Receptacle for GKS-112:

K S - 1 1 2 3 0 K S - 1 1 2 4 7

Plug:

V S - 1 1 2

All specifications are subject to change without prior notification

GKS 912

ICT-/FCT Test Probe

Grid:

≥ 2,54 mm

≥ 100 Mil

Installation height with KS: 10,2 - 26,0 mm (.402-1.024) / variable

Recommended stroke: 4,0 mm (.157)

Mounting and functional dimensions

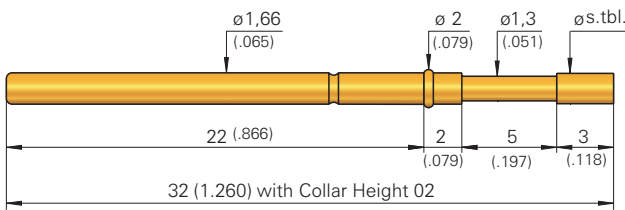

Collar height and installation height

Test probes with alternative collar heights are available to adjust the installation height of the tip (dimension without receptacle).

Collar height	Installation height without receptacle
02	10,0 mm (.394)
03	11,0 mm (.433)
04	12,0 mm (.472)
05	13,0 mm (.512)
06	14,0 mm (.551)
07	15,0 mm (.591)
10	18,0 mm (.709)

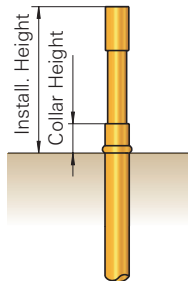

(**Tip style 00x: install. height is 0,8 mm (.031) higher)

Mechanical data

Working stroke: 4,0 mm (.157)

Maximum stroke: 5,0 mm (.197)

Spring force at work. stroke: 1,5 N (5.4oz)

Alternative: 0,6 N (2.2oz); 0,8 N (2.9oz); 2,25 N (8.1oz); 3,0 N (10.8oz); 5,0 N (18.1)

Operating temperature

Standard: -40° bis +80° C

***with spec. designation "C":** -100° up to +200° C (0,8 ; 1,5; 2,25; 3,0 N)

Electrical data

Current rating: 5 - 8 A

R_i typical: < 20 mΩ (* < 100 mΩ)

Materials

Plunger: BeCu or steel, gold-plated, rhodium- or chemically nickel-plated

Barrel: Nickel-silver or brass, gold-plated

Spring: Steel, gold-plated or stainless steel* (C)

Note:

Receptacles in the series KS-112 (shown on page 60) are used for the GKS-912 test probes series.

Available tip styles

Material	Tip style	Plating	Further versions	
			∅	∅ (inch)
2	01	A	0,60 R 0,80 R 1,00 R	(.024) (.031) (.039)
3	02	A	2,50	(.098)
3	03	A	1,80 2,50 3,50	(.071) (.098) (.138)
2	04	A	1,30 2,00 R	(.051) (.079)
3	05	A	0,70 1,40 1,50	(.028) (.055) (.059)
0	06**	A	∅ 2,30 (.091)	
2	06	R	∅ 1,50 (.059)	
3	06	A	1,40 A 1,80 A 2,50 A	(.055) (.071) (.098)
3	06	R	1,80 2,50 3,50	(.071) (.098) (.138)
2	07	A R	1,30 A 1,50 A 1,80 A 2,50 A	(.051) (.059) (.071) (.098)
2	09***	N	0,70 A 0,80 A	(.028) (.031)
2	14	A	1,30 R	(.051)
2	15***	A	1,30 A	(.051)
2	17	N	1,30 A	(.051)
2	24	R	1,30 A	(.051)
2	31	R		
2	33	N		
2	88	A		
2	91	A	1,30 N 1,30 G	(.051) (.051)
2	93	A		

** also available as tip style 0 02 or 0 03

*** pressed-in steel tip in base plunger of brass

Ordering example

Series	Tip material	Tip style	Tip diameter (1/100 mm)	Plating	Spring force (dN)	Collar height (mm)	Special designation ("C")
0 = Delrin	2 = Steel	3 = BeCu		A = Gold G = Aurum N = Nickel R = Rhodium			

Test probe:

G K S 9 1 2 2 0 4 1 3 0 A 1 5 0 2

Grid:
 ≥ 2,54 mm
 ≥ 100 Mil

Installation height with KS: 16,2 - 24,0 mm (.638 - .945) / variable
Recommended stroke: 6,4 mm (.252)

Mounting and functional dimensions

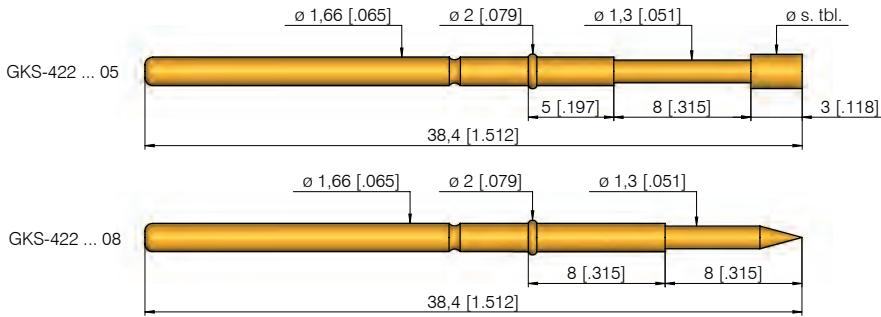

Collar height and installation height

Test probes with tip- $\varnothing > 1.3$ mm generally have a collar height of 5 mm (collar height 05).

A collar height of 8 mm (collar height 08) is recommended to provide more stability for test probes with tip- $\varnothing < 1.3$ mm.

Collar height	Installation height without receptacle
05	16 mm (.630)
08	16 mm (.630)
(** Tip styles 00x: install. height 16,8 mm (.661))	

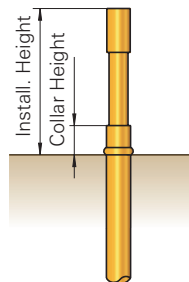

Available tip styles

Material	Tip style	Plating	Further versions	
			\varnothing	\varnothing (inch)
2	01	A	1,30 R	(.051)
3	02	A		
2	04	A		
3	05	A	0,70	(.028)
0	06 **	A		
3	06	A	1,30 1,60	(.051) (.063)
3	07	A		
2	09 ***	N	0,80 A/G 0,60 A/N	(.031) (.024)
2	14	A	0,60 2,00	(.024) (.079)
2	17	A		
2	24 ** **	A		
2	33	N	1,30 A	(.051)
2	91	N	0,80 N 1,30 A/G	(.031) (.051)
2	93	A		

** also available as tip style 0 02
 *** pressed-in steel tip in base plunger made of brass
 **** higher middle tip plus 0,5 mm

Mechanical data

Working stroke: 6,4 mm (.252)
Maximum stroke: 8,0 mm (.315)
Spring force at work. stroke: 1,5 N (5.4oz)
Alternative: 0,8 N (2.9oz); 2,25 N (8.1oz); 3,0 N (10.8oz); 5,0 N (18.1oz)

Materials

Plunger: BeCu or steel, gold-plated rhodium- or chemically nickel-plated
Barrel: Bronze, gold-plated
Spring: Steel, gold-plated or stainless steel* (C)

Note:

Receptacles in the KS-112 series (shown on page 60) are used for the GKS-422 test probes series.

Electrical data

Current rating: 5 - 8 A
R_i typical: < 20 m Ω (* < 100 m Ω)

Operating temperature

Standard: -40° up to +80° C
***with spec. designation "C":** -100° up to +200° C (1,5 N; 3,0 N)

Ordering example

Series	Tip material	Tip style	Tip diameter (1/100 mm)	Plating	Spring force (dN)	Collar height	Special designation ("C")
	0 = Delrin 2 = Steel 3 = BeCu			A = Gold G = Aurum N = Nickel R = Rhodium		05 for tip- $\varnothing > 1,3$ mm 08 recomm. for tip- $\varnothing \leq 1,3$ mm	

Test probe: (05 tip- $\varnothing > 1,3$ mm)

Test probe: (08 recomm. for tip- $\varnothing \leq 1,3$ mm)

Receptacle:

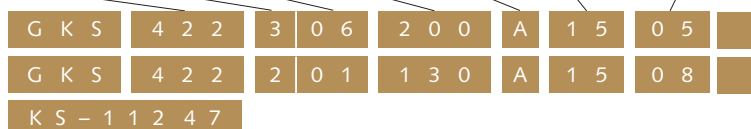

GKS 412

Long-stroke Test Probe for Dual-stage Fixture

Grid:

≥ 2,54 mm

≥ 100 Mil

Installation height with KS: 15,0 - 30,8 mm (.591 - 1.213) / variable

Recommended stroke: 8,0 mm (.315)

Mounting and functional dimensions

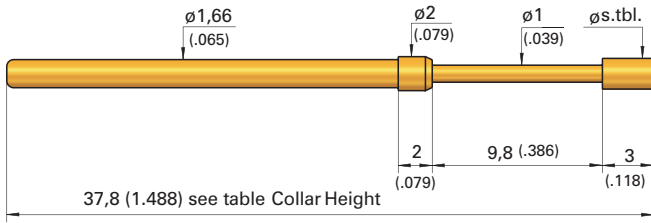

Collar height and installation height

Test probes with alternative collar heights are available to adjust the installation height of the tip (dimension without receptacle).

Collar height	Total length	Installation height without KS
02	37,8 mm (1.488)	14,8 mm (.583)
03	37,8 mm (1.488)	15,8 mm (.622)
05	40,2 mm (1.583)	17,8 mm (.701)
07	41,8 mm (1.646)	19,8 mm (.780)
10	44,8 mm (1.764)	22,8 mm (.898)

(* Tip style 00x: install. height is 0,8 mm (.315) higher)

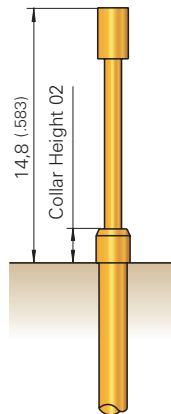

Available tip styles

Material	Tip style	Plating	Further versions	
			∅	∅ (inch)
2	01	R	∅ 1,00 (.039)	
3	03	A	∅ 1,80 (.071)	2,00 A (.079)
0	03*	A	∅ 2,30 (.091)	
2	04	R	∅ 1,30 (.051)	
2	06	R	∅ 1,30 (.051)	2,00 R (.079)
3	07	R	∅ 1,30 (.051)	
2	09**	N	∅ 0,70 (.028)	
2	14	A	∅ 1,30 (.051)	
2	17	A	∅ 2,00 (.079)	
2	24	R	∅ 2,00 (.079)	
2	25	R	∅ 1,50 (.059)	
2	88	A	∅ 1,80 (.071)	
2	91	A	∅ 1,30 (.051)	

* 0,8mm (.315) longer than standard

** pressed-in steel tip in base plunger made of brass

Mechanical data

Working stroke: 8,0 mm (.315)
Maximum stroke: 9,8 mm (.386)
Spring force at work. stroke: 1,5 N (5.4oz)
Alternative: 0,6 N (2.2oz); 3,0 N (10.8oz); 5,0 N (18.1oz)

Materials

Plunger: BeCu or steel, gold-plated, rhodium- or chemically nickel-plated
Barrel: Brass or Nickel-silver, gold-plated
Spring: Steel, gold-plated

Note:

Receptacles in the KS-112 series (shown on page 60) are used for the GKS-412 test probes series.

Electrical data

Current rating: 5 - 8 A
R_i typical: < 20 mΩ

Operating temperature

Standard: -40° up to +80° C

Ordering example

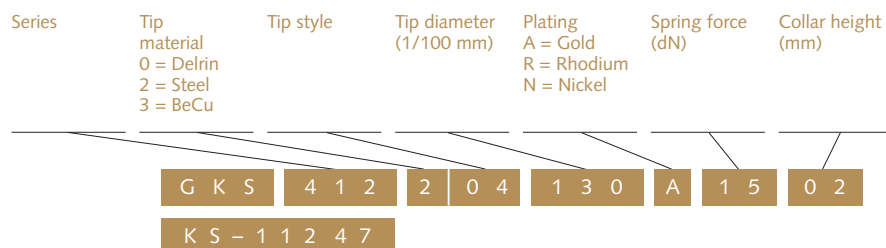

Grid:

≥ 2,54 mm

≥ 100 Mil

Installation height with KS: 16,2/18,2/23,2 mm (.638/ .717/ .913)

Recommended stroke: 8,0 mm (.315)

Mounting and functional dimensions

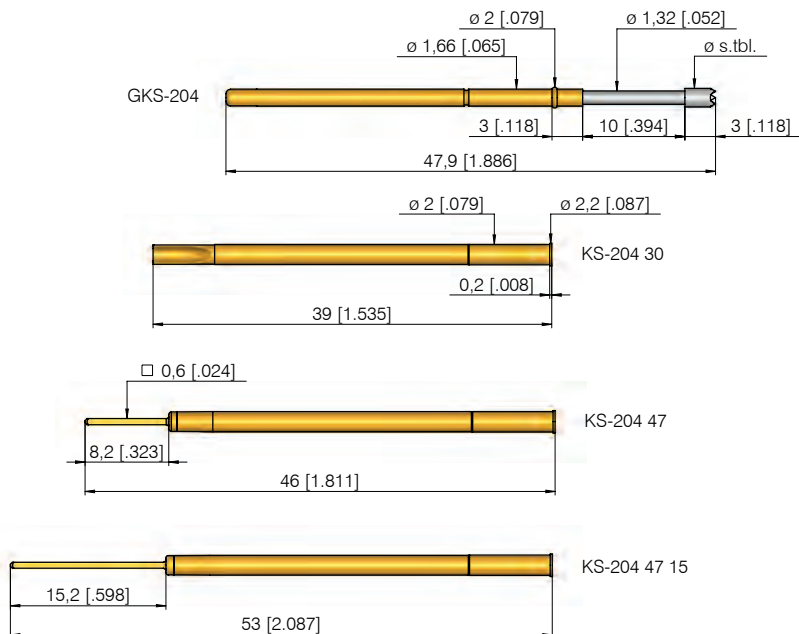

Collar height and installation height

Test probes with alternative collar heights are available to adjust the installation height of the tip (dimension without receptacle).

Collar height	Total length	Installation height without receptacle
03	47,9 mm	16,0 mm (.630)
05	47,9 mm	18,0 mm (.709)
10	47,9 mm	23,0 mm (.906)

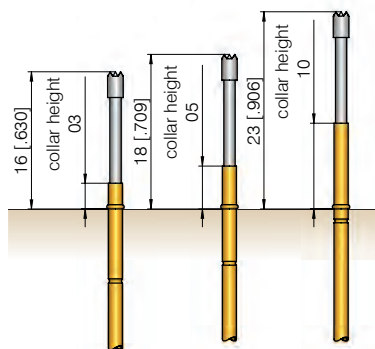

Mechanical data

Working stroke: 8,0 mm (.315)

Maximum stroke: 10,0 mm (.394)

Spring force at work. stroke: 1,5 N (5.4oz)

Alternative: 0,8 N (2.9oz); 3,0 N (10.8oz)

Electrical data

Current rating: 5 - 8 A

R_i typical: < 20 mΩ

Operating temperature

Standard: -40° up to +80° C

Materials

Plunger: BeCu or steel, gold-plated, rhodium- or chemically nickel-plated

Barrel: Nickel-silver or brass, gold-plated

Spring: Steel, gold-plated

Receptacle: Brass, gold-plated

Mounting hole size

in CEM1: $\varnothing 1,98 - 2,00$ mm (.078 - .079)

FR4: $\varnothing 1,99 - 2,01$ mm (.078 - .079)

		Available tip styles		
Material	Tip style	Plating	Further versions	
			\varnothing	\varnothing (inch)
2 01		R	$\varnothing 1,30$ (.051)	
3 02		A	$\varnothing 1,80$ (.071)	
3 03		A	$\varnothing 1,80$ (.071)	
2 04		A	$\varnothing 1,30$ (.051)	
3 05		A	$\varnothing 1,30$ (.051)	
2 06		R	$\varnothing 1,80$ (.071)	
2 07		A	$\varnothing 1,30$ (.051)	
2 09*		N	0,70 G (.028)	
2 14		A	$\varnothing 1,30$ (.051)	
2 15*		A	$\varnothing 1,80$ (.071)	
2 24		R	$\varnothing 2,00$ (.079)	
2 91		N	1,30 (.051)	
2 93		A	$\varnothing 1,60$ (.063)	

* pressed-in steel tip in base plunger made of brass

Note:

Screw-in version shown on page 126.

Ordering example

	Series	Tip material 2 = Steel 3 = BeCu	Tip style	Tip diameter (1/100 mm)	Plating A = Gold R = Rhodium N = Nickel	Spring force (dN)	Collar height (mm)
Test probe:	G K S	2	0 4	1 3 0	A	1 5	0 3
Receptacles:	K S - 2 0 4 4 7	K S - 2 0 4 4 7 1 5	K S - 2 0 4 3 0				

GKS 102

Universal Test Probe for Direct Wiring

Grid:

≥ 2,54 mm

≥ 100 Mil

Installation height with KS: 12,7 resp. 13,7 mm (.500/ .531)

Recommended stroke: 4,8 mm (.189)

Mounting and functional dimensions

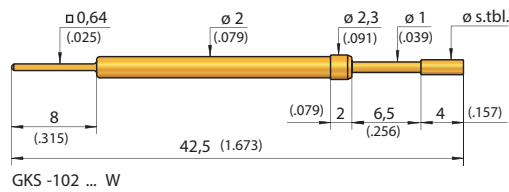

GKS -102 ... W

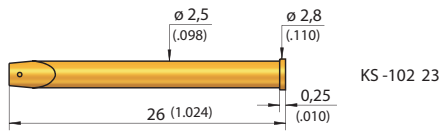

KS -102 23

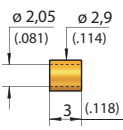

DS -102 03

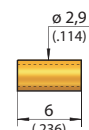

DS -102 06

Available tip styles

Material	Tip style	Plating	Further versions	
			∅	∅ (inch)
2 01		A		
1 02		A	2,30	(.091)
1 03		A		
2 04		A		
3 05		A		
3 06		A		
2 50*		P		

* PCB support probe: insulating tip made of PVC installation height 13,5 mm (.531), Total length 43,5 mm

Collar height and installation height

The installation height of the tip (dimension without receptacle) is defined by the collar height.

Collar height	Installation height without receptacle
02 Tip style 01 to 06	12,5 mm (.492)
02 Tip style 50*	13,5 mm (.531)

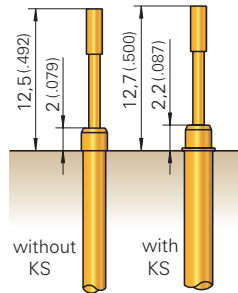

Mechanical data

Working stroke: 4,8 mm (.189)
Maximum stroke: 6,5 mm (.256)
Spring force at work. stroke: 1,5 N (5.4oz)
Alternative: 3,0 N (10.8oz); 5,0 N (18.1oz)

Materials

Plunger: Brass or steel, gold-plated
Barrel: Brass, gold-plated
Spring: Steel, gold-plated
Receptacle: Brass, gold-plated

Note:

The receptacle can be used from grid size 3,50 mm (140 Mil) upwards.

Electrical data

Current rating: 5 - 8 A
R_i typical: < 20 mΩ

Mounting hole size

with receptacle: ∅ 2,48 - 2,49 mm (.0976 - .0980)

Operating temperature

Standard: -40° up to +80° C

without receptacle:

in CEM1: ∅ 1,98 - 2,00 mm (.0780 - .0787)
in FR4: ∅ 1,99 - 2,01 mm (.0783 - .0791)

Ordering example

Series	Tip material	Tip style	Tip diameter	Plating	Spring force	Collar height	Type
	1 = Brass 2 = Steel 3 = BeCu		(1/100 mm)	A = Gold P = PVC	(dN)	(mm)	

Test probe:

G K S 1 0 2 1 0 2 1 4 0 A 1 5 0 2 W

Receptacle:

K S - 1 0 2 2 3

Spacers:

D S - 1 0 2 0 3 D S - 1 0 2 0 6

Grid:
 ≥ 2,54 mm
 ≥ 100 Mil

Installation height with KS: 12,2 resp. 13,2 mm (.480/ .520)
Recommended stroke: 5,6 mm (.220)

Mounting and functional dimensions

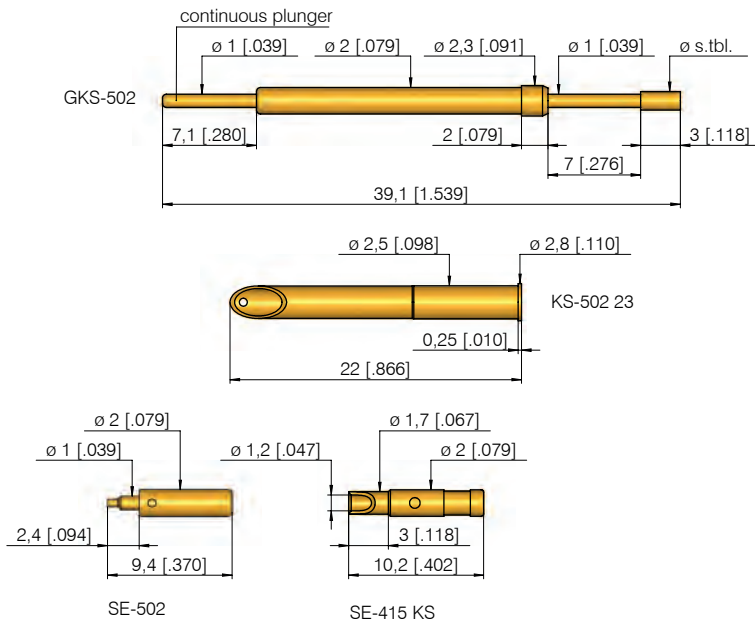

Available tip styles

Material	Tip style	Plating	Further versions	
			ϕ	ϕ (inch)
3 02		A	$\phi 1,40$ (.055)	
3 03		A	$\phi 1,80$ (.071)	
3 04		A	$\phi 1,40$ (.055)	
2 33 ***		R	$\phi 2,50$ (.098)	
3 53 **		A	$\phi 2,50$ (.098)	
3 56 **		A	$\phi 2,50$ (.098)	2,50 R (.098)

** tip length 4 mm (.157)
 *** tip length 4 mm (.157), special designation "L"

Metric
 Stand. GKS

Collar height and installation height

The installation height of the tip (dimension without receptacle) is defined by the collar height.

Collar height	Tip style	Install. height with KS
02	02 / 03 / 04	12,2 mm (.4803)
02	33 / 53 / 56	13,2 mm (.5197)

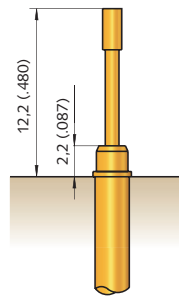

Mechanical data

Working stroke: 5,6 mm (.220)
Maximum stroke: 7,0 mm (.276)
Spring force at work. stroke: 1,5 N (5.4oz)
Alternative: 0,8 N (2.9oz); 3,5 N (12.5oz); 5,0 N (18.1oz)

Materials

Plunger: BeCu or steel, gold- or rhodium-plated
Barrel: Brass, gold-plated
Spring: Steel, gold-plated or stainless steel*
Receptacle: Brass, gold-plated

Note:

The receptacle can be used from grid size 3,50 mm (140 Mil) upwards.

Electrical data

Current rating, conn. to plunger: 12-15 A
Current rating, connection to KS: 5 - 8 A
R_i typical, connection to plunger: < 10 mΩ
R_i typical, connection to KS: < 30 mΩ (*< 100 mΩ)

Mounting hole size

in CEM1 and FR4:
with receptacle: $\phi 2,48 - 2,49$ mm (.0976 - .0980)
without receptacle: $\phi 2,00$ mm (.0787)

Operating temperature

Standard: -40° up to +80° C
***with 5,0 N-spring:** -100° up to +200° C

Ordering example

Series	Tip material 2 = Steel 3 = BeCu	Tip style	Tip diameter (1/100 mm)	Plating A = Gold R = Rhodium	Spring force (dN)	Collar height (mm)	Special designation "L"
Test probe:	G K S	5 0 2	3	0 2	1 4 0	A	1 5 0 2
Receptacle:	K S - 5 0 2 2 3						
Plug:	S E - 5 0 2		S E - 4 1 5 K S		(for plugging onto the end of the plunger)		

GKS 113

Test Probe

Grid:

≥ 4,00 mm

≥ 160 Mil

Installation height with KS: 10,5/13,5/18,5 mm (.413/ .531/ .728)

Recommended stroke: 4,0 mm (.157)

Mounting and functional dimensions

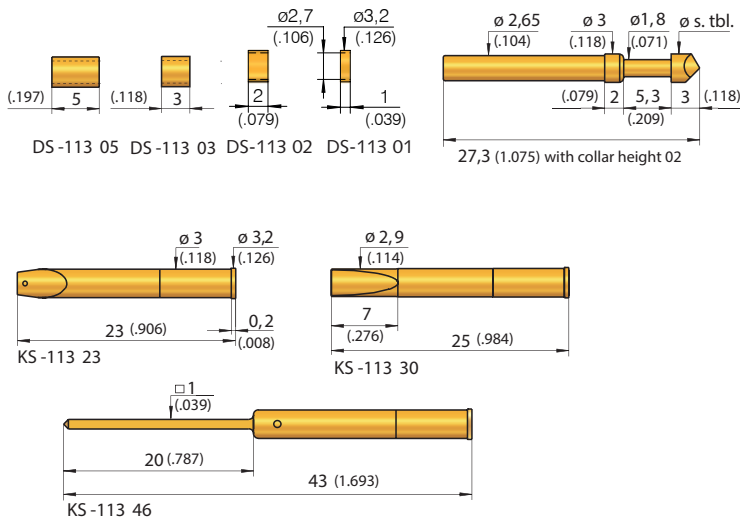

Collar height and installation height

The installation height of the tip (dimension measured with receptacle) is defined by the collar height.

Collar height	Installation height with receptacle
02	10,5 mm (.413)
05	13,5 mm (.531)
10	18,5 mm (.728)

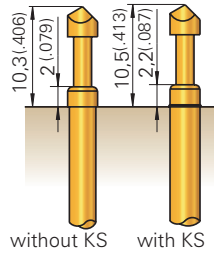

Mechanical data

Working stroke: 4,0 mm (.157)
Maximum stroke: 5,3 mm (.209)
Spring force at work. stroke: 1,5 N (5.4oz)
Alternative: 0,3 (1.1oz); 0,6 (2.2oz); 1,0 (3.6oz); 2,25 (8.1oz); 3,0 (10.8oz); 5,0 N (18.1oz)

Electrical data

Current rating: 5 - 8 A
R_i typical: < 30 mΩ (* < 100 mΩ)

Operating temperature

Standard: -40° up to +80° C
***with Spec. Designations "C":** -100° up to +200° C (1,5 N; 2,25 N; 3,0 N)

Materials

Plunger: BeCu or steel, gold-, rhodium- or chemically nickel-plated
Barrel: Brass, gold-plated
Spring: Steel, gold-plated or stainless steel*(C)
Receptacles: Brass, gold-plated

Mounting hole size

for GKS-113 and KS-113:
with receptacle: ∅ 2,98 - 2,99 mm (.1173 - .1177)
without receptacle: ∅ 2,65 mm (.1043)

Note:

Screw-in version shown on page 128.

Available tip styles

Material	Tip style	Plating	Further versions	
			∅	∅ (inch)
2	01	R		
3	02	A	0,80 1,00 1,80 3,00 4,00	(.031) (.039) (.071) (.118) (.157)
2	03	A		
3	03	A	4,00 R	(.157)
2	04	R	1,80 A 3,00	(.071) (.118)
3	05	A	0,80 1,40 3,00 R	(.031) (.055) (.118)
3	55	R		
Tip 1 mm (.0394) longer				
3	06	A	1,60 2,30 4,00 8,00	(.063) (.091) (.157) (.315)
3	06	R	2,50 3,00 3,50 4,00 6,00	(.098) (.118) (.138) (.157) (.236)
2	07	A		
3	07	R		
3	12	A		
3	13	R		
2	14	R		
2	15**	A		
Tip 2,5 mm (.0984) longer				
2	17	R	1,80 3,00 A	(.071) (.118)
3	19	A	3,00	(.118)
3	72	A		
2	87	N	4,00	(.157)
2	88	A		

** pressed-in steel Tip in base plunger made of brass

Ordering example

	Series	Tip material 2 = Steel 3 = BeCu	Tip style	Tip diameter (1/100 mm)	Plating A = Gold R = Rhodium	Spring force (dN)	Collar height (mm)	Special designation (alternative "C")
Test probe:	G K S	1	1 3	3	0 6	2 3 0	R	1 5 0 2
Receptacles:	K S - 1 1 3	2 3	K S - 1 1 3	3 0	K S - 1 1 3	4 6		
Spacers:	D S - 1 1 3	0 2	D S - 1 1 3	0 3	D S - 1 1 3	0 5		

Grid:
 ≥ 4,00 mm
 ≥ 160 Mil

Installation height: 7,3 / 9,0 mm (.287 / .354)
Recommended stroke: 2,8 mm (.110)

Mounting and functional dimensions

GKS-913

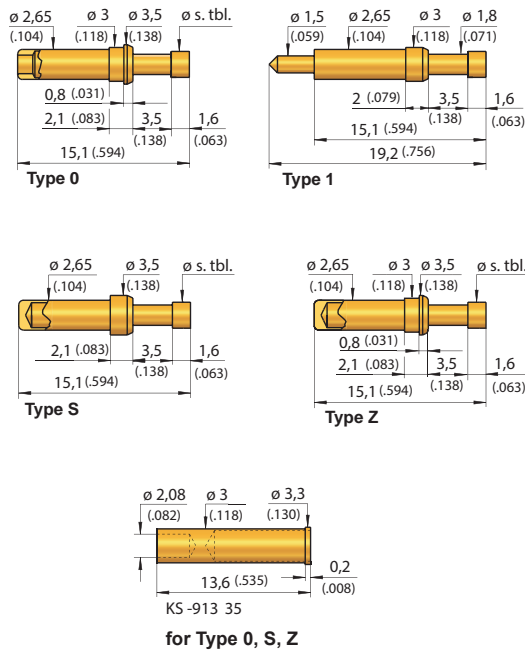

Mechanical data

Working stroke: 2,8 mm (.110)
Maximum stroke: shown on table on the right
Spring force at work. stroke: 1,5 N (5.4oz)
Alternative: 0,8 N (2.9oz); 2,5 N (9.0oz)

Operating temperature

Standard: -40° up to +80° C
***** with spec. designation "C":** -100° up to +200° C (1,5 N)

Electrical data

Current rating: 5 - 8 A (24 A****)
R_i typical: < 20 mΩ (**** < 100 mΩ)

Materials

Plunger: Brass or BeCu, gold- or rhodium-plated
Barrel: Brass, gold-plated
Spring: Steel, gold-plated or stainless steel **** (C)
Receptacle: Brass, gold-plated

Mounting hole size

in materials CEM1 and FR4:
with receptacle: $\varnothing 2,98 - 2,99$ mm (.1173 - .1177)
without receptacle: $\varnothing 2,65$ mm (.1043)

Note:

Version

- 0 End of probe barrel open
- 1 End of probe barrel with solder terminal
- S End of probe barrel closed; can be soldered into PCB
- Z End of probe barrel closed; can be soldered into PCB

Warning: Probes should be soldered with great care. Ensure the inside of the barrel is not exposed to high temperatures, because this could destroy the spring.

The KS-913 35 receptacle can only be combined with the probe types 0, S and Z.

Available tip styles

Material	Tip style	Plating	Further versions	
			\varnothing	\varnothing (inch)
1 02		A	3,50	(.138)
3 03		A		
3 05		A		
3 06*		A		
3 06		A	3,50 R 2,30 R	(.138) (.091)
3 08		R		
3 58**		R		

Tip length: 3,4 mm (.134)

Collar height and installation height

The installation height of the tip is defined by the collar height.

Type 0, S, Z			
Collar height	Tip style	Install. height without KS in mm	max. stroke mm
02	02/05/06/08	7,2 (.283)	3,5 (.138)
02	06 180*	7,2 (.283)	3,2 (.126)
02	58**	8,8 (.346)	3,3 (.130)

Type 1			
Collar height	Tip style	Install. height without KS in mm	max. stroke mm
02	02/05/06/08	7,1 (.280)	3,5 (.138)
02	06 180*	7,1 (.280)	3,2 (.126)
02	58**	8,7 (.343)	3,3 (.130)

**** For applications up to 24 Amps: HSS-520 (M), see page 87.

Note:

Screw-in version GKS-913 M shown on page 127.

Ordering example

Series	Tip material	Tip style	Tip diameter (1/100 mm)	Plating	Spring force (dN)	Collar height (mm)	Type
	1 = Brass 3 = BeCu			A = Gold			1, 0, S, Z, 1C, 0C, SC, ZC

Test probe:

G K S 9 1 3 3 0 8 2 3 0 R 1 5 0 2 0

Receptacles:

K S - 9 1 3 3 5

GKS 103

Universal Test Probe with High Stability

Grid:

≥ 4,00 mm

≥ 160 Mil

Installation height with KS: 12,5 mm (.492)

Recommended stroke: 4,8 mm (.189)

Mounting and functional dimensions

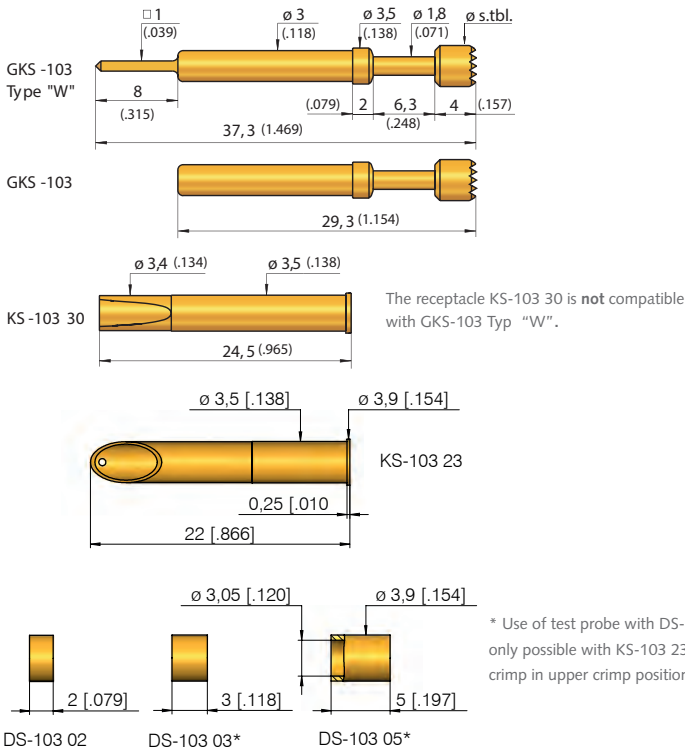

* Use of test probe with DS-103 03 and DS-103 05 spacers only possible with KS-103 23-2 (receptacle with stronger crimp in upper crimp position).

Collar height and installation height

The installation height of the tip is determined by the collar height.

Collar height	Installation height without receptacle
02	12,3 mm (.484)

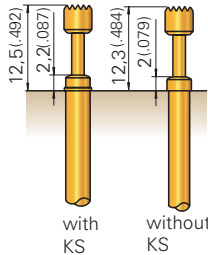

Mechanical data

Working stroke: 4,8 mm (.189)
Maximum stroke: 6,0 mm (.236)
Spring force at work. stroke: 1,5 N (5.4oz)
Alternative: 0,8 N (2.9oz); 3,0 N (10.8oz), 5,0 N (18.1oz)

Materials

Plunger: Steel or brass, gold-plated
Barrel: Brass, gold-plated
Spring: Steel, gold-plated or stainless steel** (C)
Receptacle: Brass, gold-plated

Note:

The receptacle can be used from grid size 4,50 mm (177 Mil) upwards.

Electrical data

Current rating: 5 - 8 A
R_i typical: < 30 mΩ (**< 100 mΩ)

Mounting hole size

with receptacle: \varnothing 3,48 - 3,49 mm (.1370 - .1374)
without receptacle: \varnothing 3,00 mm (.1181)

Note:

Screw-in version shown on page 129.

Operating temperature

Standard: -40° bis +80° C
**** with spec. designation "C":** -100° up to +200° C (1,5 N; 3,0 N; 5,0 N)

Ordering example

Series	Tip material 1 = Brass 2 = Steel	Tip style	Tip diameter (1/100 mm)	Plating A = Gold	Spring force (dN)	Collar height (mm)	Type alternative "W" "C", "WC"
--------	--	-----------	----------------------------	---------------------	----------------------	-----------------------	-----------------------------------

Test probe:

G K S 1 0 3 2 0 1 1 8 0 A 1 5 0 2

Receptacles:

K S - 1 0 3 2 3 K S - 1 0 3 2 3 - 2 K S - 1 0 3 3 0

Spacers:

D S - 1 0 3 0 2 D S - 1 0 3 0 3 D S - 1 0 3 0 5

Available tip styles

Material	Tip style	Plating	Further versions	
			\varnothing	\varnothing (inch)
2 01		A	$\varnothing 1,80$ (.071)	
1 02		A	$\varnothing 2,30$ (.091)	4,00 (.157)
2 02		A	$\varnothing 6,50$ (.256)	
1 03		A	$\varnothing 2,30$ (.091)	4,00 (.157)
2 04		A	$\varnothing 2,30$ (.091)	4,00 (.157)
1 05		A	$\varnothing 2,30$ (.091)	4,00 (.157)
2 06		A	$\varnothing 2,30$ (.091)	4,00 (.157) 6,50 (.256) 9,00 (.354)

Grid:
 ≥ 4,00 mm
 ≥ 160 Mil

Installation height with KS: 13,2 mm (.520)
Recommended stroke: 5,6 mm (.220)

Mounting and functional dimensions

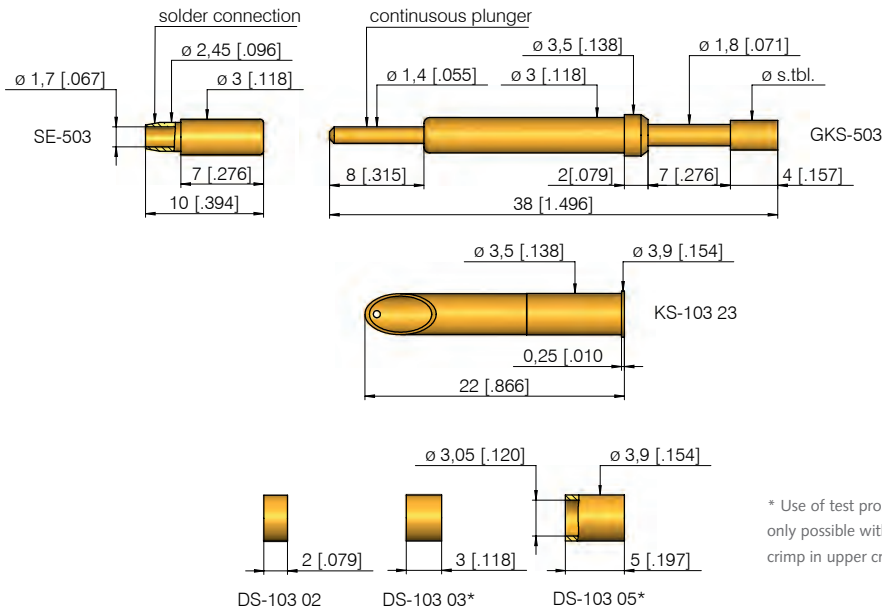

Material		Tip style	Tip diameter	Plating	Further versions	
					Ø	Ø (inch)
2	01		Ø 1,80 (.071)	R		
3	03		Ø 4,00 (.157)	A		
3	04		Ø 4,00 (.157)	R		
2	05		Ø 1,80 (.071)	R		
3	06		Ø 4,00 (.157)	R A	3,00 R	(.118)
2	06		Ø 1,80 (.071)	R		

* Use of test probe with DS-103 03 and DS-103 05 spacers only possible with KS-103 23-2 (receptacle with stronger crimp in upper crimp position)

Collar height and installation height

The installation height of the tip is determined by the collar height.

Collar height	Installation height without receptacles
02	13,0 mm (.512)

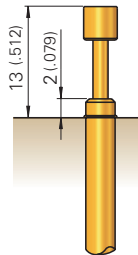

Mechanical data

Working stroke: 5,6 mm (.220)
Maximum stroke: 7,0 mm (.276)
Spring force at work. stroke: 1,5 N (5.4oz)
Alternative: 3,0 N (10.8oz), 5,0 N** (18.1oz)

Materials

Plunger: Steel or BeCu, gold- or rhodium-plated
Barrel: Brass, gold-plated
Spring: Steel, gold-plated or stainless steel**
Receptacle: Brass, gold-plated

Note:

The receptacle can be used from grid size 4,50 mm (180 Mil) upwards.

Electrical data

Current rating, conn. to plunger: 12-15 A
Current rating, connection to KS: 5 - 8 A
R_i typical, connection to plunger: < 10 mΩ
R_i typical, connection to KS: < 30 mΩ
 (** < 100 mΩ)

Mounting hole size

with receptacle: Ø 3,48 - 3,49 mm (.1370 - .1374)
without receptacle: Ø 3,00 mm (.1181)

Note:

Screw-in version shown on page 130.

Operating temperature

Standard: -40° up to +80° C
**** with 5,0 N spring:** -100° up to +200° C

Ordering example

	Series	Tip material 2 = Steel 3 = BeCu	Tip style	Tip diameter (1/100 mm)	Plating A = Gold R = Rhodium	Spring force (dN)	Collar height (mm)
Test probe:	G K S	5 0 3	2 0 1	1 8 0	R	1 5	0 2
Receptacles:	K S - 1 0 3 2 3		K S - 1 0 0 2 3 - 2				
Spacers:	D S - 1 0 3 0 2		D S - 1 0 3 0 3		D S - 1 0 3 0 5		
Lamellar plug: (for plugging onto the end of the plunger)	S E - 5 0 3						

GKS 854

Universal Test Probe with High Stability

Grid:

≥ 5,08 mm

≥ 200 Mil

Installation height with KS: 10,8 mm (.425)

Recommended stroke: 4,0 mm (.157)

Mounting and functional dimensions

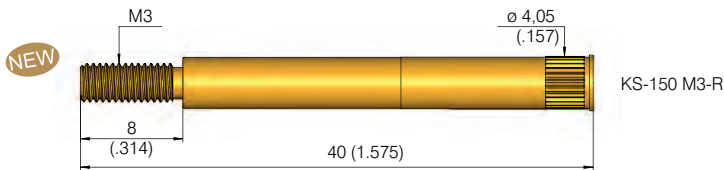
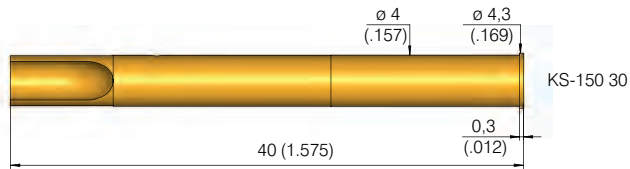
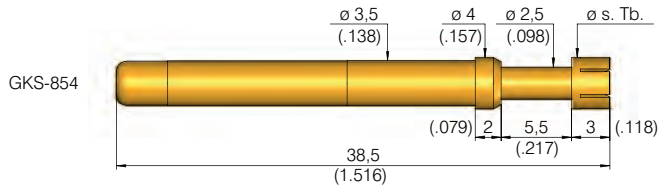

Available tip styles

Material	Tip style	Plating	Further versions	
			∅	∅ (inch)
3	06	A	∅ 4,00 (.157)	
3	19	A	∅ 4,00 (.157)	

Collar height and installation height

The installation height of the tip (measured with the receptacle) is determined by the collar height. The test probe can only be used with a receptacle.

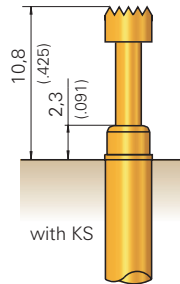

Collar height	Installation height (with receptacle)
02	10,8 mm

Mechanical data

Working stroke: 4,4 mm (.173)
Maximum stroke: 5,5 mm (.217)
Spring forces at work. str.: 3,0 N (10.8oz)
Alternative: 5,0 N (18.1oz)

Materials

Plunger: BeCu, gold-plated
Barrel: Brass, gold-plated
Spring: Steel, gold-plated or stainless steel * (C)
Receptacle: Brass, gold-plated

Note:

Screw-in version shown on page 132.

Electrical data

Current rating: 10 - 12 A
R_i typical: < 20 mΩ (* < 100 mΩ)

Mounting hole size

for KS-150 30 in CEM1 and FR4: ∅ 3,98 - 3,99 mm (.1567 - .1571)
for KS-150 M3-R in CEM1 and FR4: ∅ 4,00 - 4,02 mm (.1570 - .1580)

Operating temperature

Standard: -40° up to +80° C
***with spec. design. "C":** -100° up to +200° C (5,0 N)

Ordering example

Series	Tip material 3 = BeCu	Tip style	Tip diameter (1/100 mm)	Plating A = Gold	Spring force (dN)	Collar height (mm)	Special designation "C"
--------	--------------------------	-----------	----------------------------	---------------------	----------------------	-----------------------	----------------------------

Test probe:

G K S 8 5 4 3 1 9 4 0 0 A 3 0 0 2

Receptacles:

K S - 1 5 0 3 0 K S - 1 5 0 M 3 - R

Sealed with **EXCELLENCE.**

Contacting solutions up to 12 GHz for every industry and application:
The **radio frequency test probes** from INGUN enable precise RF performance and resistance measurements with repeatable accuracy.

An unbeatable range of RF test probes for:

- Plug connector contacting
- Mini-switch contacting
- PCB contacting
- Dipole contacting

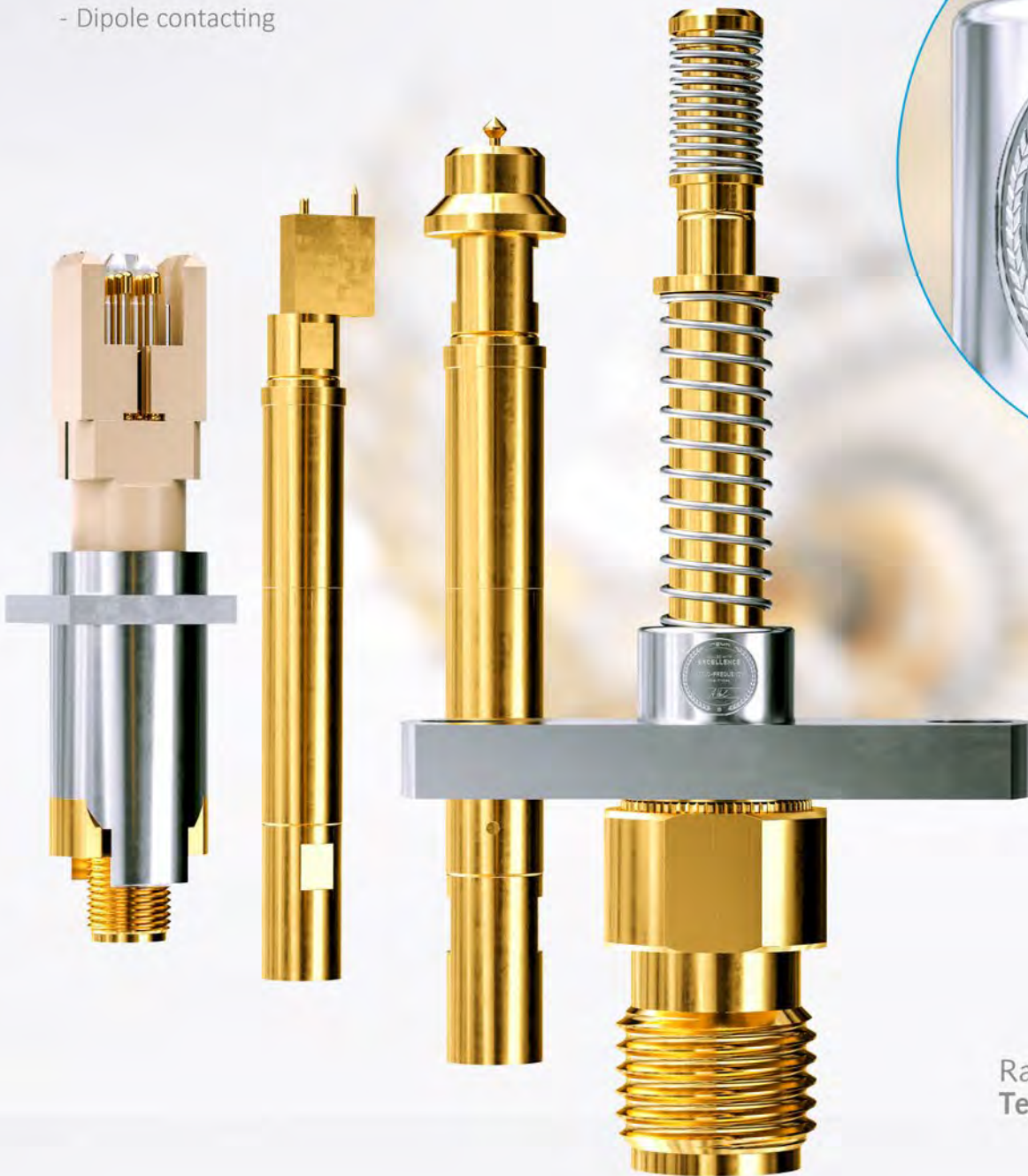

Radio Frequency
Test Probes

www.ingun.com

High Current Test Probes (Low-Ohm Test Probes)

High current test probes are used in several industries and applications with high currents, such as testing, function tests, signal transmission, power supply in production, as well as assembled contact elements. Another field of application is precise measurement, which requires test probes with very low internal resistance, so-called **low-Ohm test probes**.

For secure transmission of high currents, the plungers in INGUN high current test probes consist of two parts. During the stroke movement the plunger parts are deflected away

from each other in a radial direction. In doing so, the plunger parts press against the barrel and the transfer resistance (R_i) is reduced. This principle allows the transmission of high currents with limited warming. The power loss, which causes warming, is calculated using the formula $P_V = R_i \cdot I^2$.

The permitted current load capacity of each test probe can be taken from the current rating graphs. The maximum permitted ambient temperature at rated current can be found in the current de-rating graphs.

Contacting of high current series and plug connector components

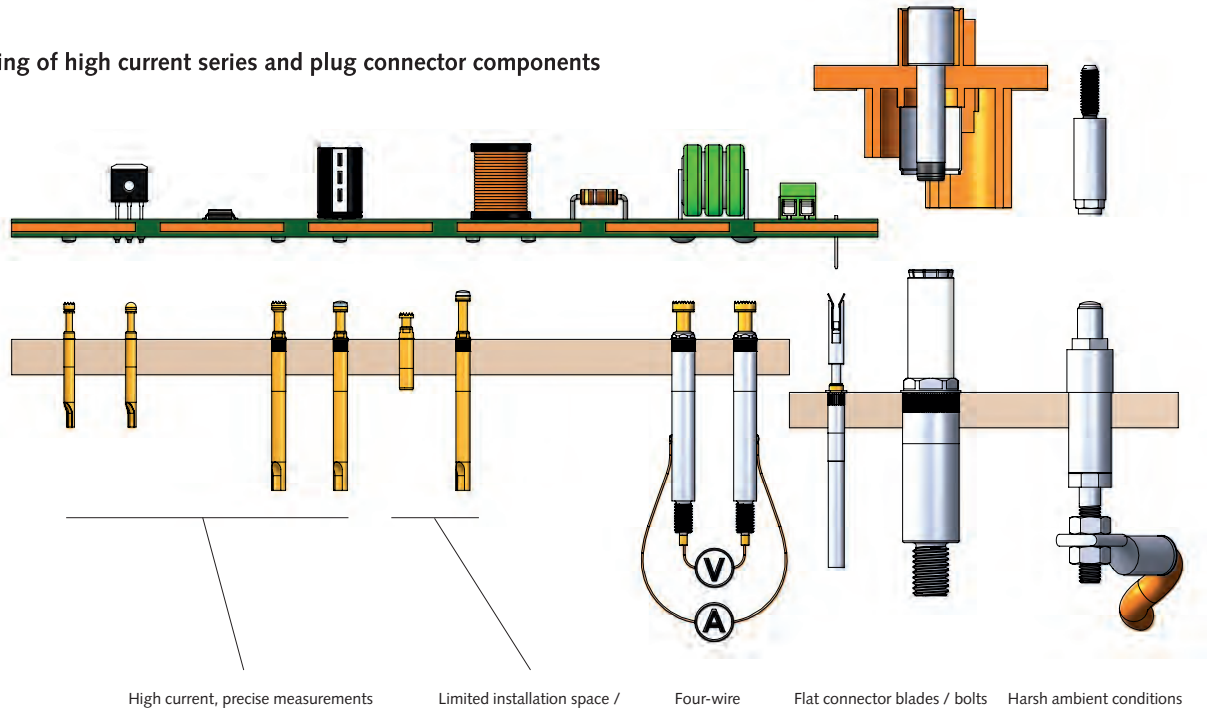

Grid size / Series (max. current)	Standard high current test probes (press-in)	Standard high current test probes (screw-in)	Short-stroke and long-stroke high current test probes	Dipole high current probes (Kelvin probes)	High current clamps (flat / round)	Robust high current probes (probes / contact terminal)
≥ 2.54 mm (≥ 100 Mil)	HSS-118 (20 A)	HSS-118 M (20 A)	HSS-827 M (20 A)	-	-	-
≥ 4.00 mm (≥ 160 Mil)	HSS-120 (30 A)	HSS-120 M (30 A)	HSS-520 / M (30 A)	NEW VK-541 (10 A)	NEW KK-541 (20 A)	-
≥ 5.08 mm (≥ 200 Mil)	HSS-150 (50 A)	HSS-150 M (50 A)	HSS-552 M (50 A) HSS-150 H / MH (50 A)	-	-	-
6.0 to 7.5 mm (250 to 300 Mil)	-	NEW HSS-621 M (75 A) NEW HSS-623 M (100A)	-	NEW HSS-624 M (100 A)	NEW HKF-617 (40 A) NEW HKR-694 (40 A)	-
12.0 to 35.0 mm (470 to 1400 Mil)	-	-	-	-	NEW HKR-612 M (100 A) NEW HKR-672 M (200 A)	HSS-2259 (25 A) to HSS-2532 (400 A)
Page(s)	78 / 80 / 82	79 / 81 / 83 / 84 - 85	86 - 89	92 - 93	94 - 98	99

Depending on the application and the related test demands, INGUN offers various high current test probes (HSS):

Standard HSS are unrivalled HSS probes with an optimal ratio of rated current load of 20 to 100 Amps in a compact design. Both press-in versions and screw-in versions are available.

Short-stroke HSS and long-stroke HSS are used in applications where limited test space is available, or contacting which requires a long stroke (e.g. dual-stage contacting).

International standard probes are high current test probes without a collar. The installation height of these probes is adjusted using the receptacle.

Dipole high current probes (Kelvin probes) four-wire measurements can be performed to precisely define resistance. In doing so, the voltage (V) on the inner conductor and the current (A) on the outer conductor are measured.

High current clamps (round/flat) are used to contact flat connector blades and round posts, such as those found in plug connectors. PCBs and threaded bolts can also be contacted. Four-wire clamps are suitable for performing four-wire measurements.

Robust high current probes are used wherever challenging atmospheric conditions, side force or vibrations can occur. These robust probes are also suitable as a permanently assembled contact element in machinery.

Various installation options are available to mount the probes. The high current test probes can either be pressed in or screwed in the receptacle. Mounting without a receptacle is also possible. Screw-in probes are recommended for applications with vibrations, overhead installation and where there is a danger of test probe moving out of the receptacle (snapping effect). Screw-in probes have the designation 'M' at the end of the part number. Corresponding tools can be found in the 'Tools' chapter.

High Current Test Probes (Low Ohm Test Probes)

Standard high current test probes (press-in/screw-in)	78 - 85
Short-stroke high current test probes	86 - 88
Long-stroke high current test probes	89
International standard test probes	90
Dipole high current test probes	92 - 93
High current clamps (flat/round)	94 - 98
Robust high current test probes (probe/contact terminal)	99

HSS
short / long

Note:
See next page for overview and comparison table.

High Current Test Probes Overview and Comparison

High current probe (HSS) version	Series	Grid size (≥ mm)	Working stroke (mm)	Max. stroke (mm)	Current rating (A)	Spring forces (N)		Installation height with receptacle (KS) (mm)		Min. probe length (mm)	Compatible test probes (GKS)	Page
						min	max	min	max			
Standard high current test probes (press-in/screw-in)	HSS-118	2.54	4	5.3/8	20	1.5	3	10.5	18.5	32.3	GKS-112	78
	HSS-118 M	2.54	4	5.3/8	20	1.5	3	10.5	-	35.3	GKS-112 M	79
	HSS-120	4	4	5.3	30	1.5	3	10.5	18.5	27.3	GKS-113	80
	HSS-120 M	4	4	5.3	30	1.5	3	10.5	-	28.3	GKS-113 M	81
	HSS-150	5.08	4.4	5.5	50	3	10	10.8	-	38.5	GKS-854	82
	HSS-150 M	5.08	4.4	5.5	50	3	10	10.8	-	43.1	GKS-854 M	83
	NEW HSS-621 M	6.35	4.4	5.5	75	5	10	10.8	-	43.1	-	84
NEW HSS-623 M	7.6	4.4	5.5	100	7	15	10.8	-	52.1	-	85	
Short-stroke high current test probes	HSS-827 M	2.54	3.5	4.5	20	1.5	2.5	8.7	-	19.5	GKS-427 M	86
	HSS-520 (M)	4	2.8	3.5	30	1.5	-	7.3	7.4	15.1	GKS-913/M	87
	HSS-552 M	5.08	2	2.5	50	2	-	7.5	-	17.1	-	88
Long-stroke high current test probes	HSS-150 H (MH)	5.08	7.4	8.5	50	3	10	13.8	-	46.1	-	89
International standard test probes	HSS-005	4.75	4.4	6.35	40	3	5	8.9	-	36.1	GKS-005	90
Dipole high current test probes / 4-wire clip	NEW HSS-624 M	7.6	4.4	5.5	100	9	-	10.8	-	61.8	-	92
	NEW VK-541	3.5	3.5	6.5	10	-	-	19.1	-	53.4	-	93
High current clamps (flat / round)	NEW HKF-617	5.5	4.4	5.5	20/40	10	-	27.9	-	57.9	-	94
	NEW KK-541	3.5	3.5	6.5	20	-	-	16.35	16.55	34.35	-	95
	NEW HKR-612 M	10-12.5	4.4	5.5	35/35/100	10	20	29.5	-	57	-	96
	NEW HKR-672 M	18-22	4	5.5	200	20	-	33.5	34.7	72.7	-	97
	NEW HKR-694	5.5	4.4	5.5	15	10	-	26.2	-	56.2	-	98
Robust high current test probes (probe / contact terminal)	HSS-2259	12	7	9.5	25	10	-	37.5	-	57.5	-	99
	HSS-2513	16	7	10.5	35	12	-	52.5	-	79.5	-	99
	HSS-2516	20	7	12	100	17	-	54.2	-	81.2	-	99
	HSS-2526	30	7	11	200	58	-	53	-	90	-	99
	HSS-2532	35	7	11	400	116	-	53	-	114	-	99

Further technical information:
The permitted current rating for each test probe can be taken from the current rating charts. The maximum permitted ambient temperature at nominal current can be read from the current de-rating charts.

Note: The measurements for the charts were conducted using test probes with tip style 06 (serrated) and spring force 1.5 N. Using other tip styles with smaller contact surfaces reduces the nominal current rating. Furthermore, spring forces < 1.5 N are not recommended for high current applications.

Example: HSS-150

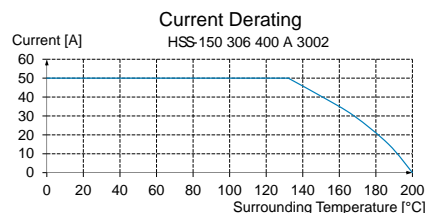
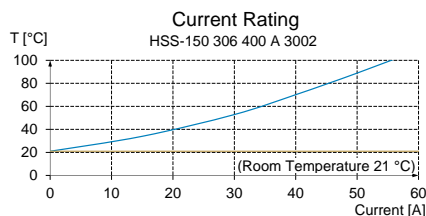

Standard HSS

Short-stroke and Long-stroke HSS

International Standard Probes

Standard high current test probes are unrivalled, variable high current test probes with an optimal ratio of rated current load of 20 to 100 Amps in a compact design. These probes are available with a wide range of tip styles and in a variety of diameters. In addition, a choice of spring forces and various collar heights can be ordered to vary the installation height.

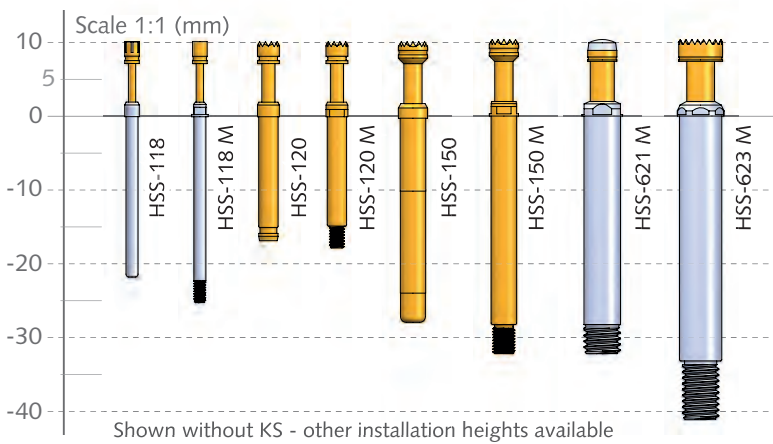

Short-stroke high current test probes are ideally suited to applications with limited test space available. As with the standard probes, various mounting options are available.

Long-stroke high current test probes are suitable for contacting situations which require a long stroke, e.g. dual-stage contacting.

International standard probes are high current test probes without a collar. The installation height of these probes is adjusted using the receptacle.

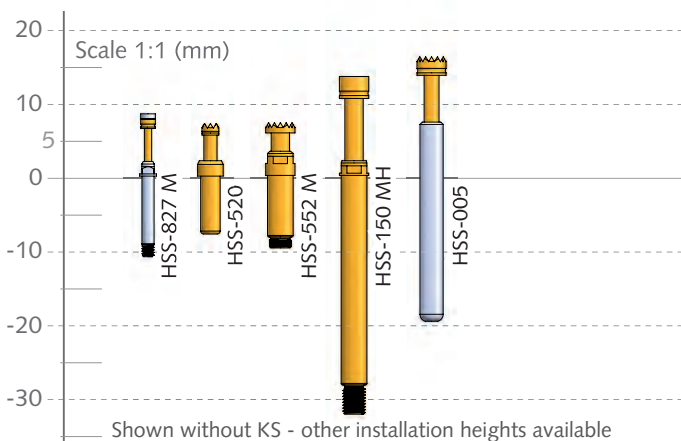

Standard High Current Test Probes (press-in/screw-in)

HSS-118	78
HSS-118 M	79
HSS-120	80
HSS-120 M	81
HSS-150	82
HSS-150 M	83
HSS-621 M NEW	84
HSS-623 M NEW	85

Short-stroke High Current Test Probes

HSS-827 M	86
HSS-520 (M)	87
HSS-552 M	88

Long-stroke High Current Test Probes

HSS-150 H (MH)	89
----------------	----

International Standard Test Probes

HSS-005	90
---------	----

HSS short / long

Note:

See page 76 for overview and comparison table.

HSS 118

High Current Probe up to 20 A
Plug-in Test Probe

Grid:

≥ 2,54 mm

≥ 100 Mil

Installation height with KS: 10,5 resp. 18,5 mm (.413/ .728)

Recommended stroke: 4,0 mm (.157)

Mounting and functional dimensions

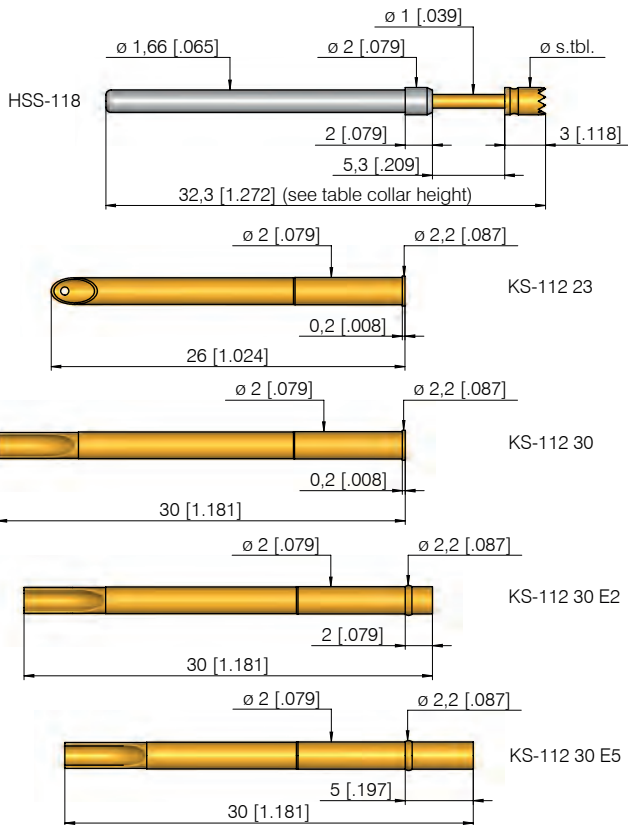

Available tip styles

Material	Tip style	Plating	Further versions	
			ϕ	ϕ (inch)
3 02		A	$\phi 1,00$ (.039)	
3 03		A	$\phi 2,00$ (.079)	
3 05		A	$\phi 0,80$ (.031)	0,65 (.026)
3 05		A	$\phi 1,00$ (.039)	
3 05*		S	$\phi 2,00$ (.079)	
3 06		A	$\phi 2,00$ (.079)	1,30 (.051) 1,60 (.063) 1,80 (.071) 2,50 (.098) 3,50 (.138)
2 14		A	$\phi 1,30$ (.051)	
3 17		A	$\phi 1,75$ (.069)	2,00 (.079)
3 19		A	$\phi 2,00$ (.079)	
3 53**		S	$\phi 2,00$ (.079)	

* pressed-on silver head

** pressed-on silver head, tip length 3,5 mm (.138)
installation height plus 0,5 mm (.020)

Collar height	02	03	04	05	06	07	08	09	10
Total length (mm)	32,3	33,3	34,3	35,3	36,3	37,3	38,3	39,3	40,3
Installation height without receptacle (mm)	10,3	11,3	12,3	13,3	14,3	15,3	16,3	17,3	18,3

Compatible GKS

GKS-112 (assembled in same receptacle)

Materials

Plunger: BeCu or steel, gold-plated
Barrel: Brass, silver-plated
Spring: Stainless steel, gold-plated
Receptacle: Brass, gold-plated

Operating temperature

Standard: -100° up to +200° C

Mounting hole size

for KS-112 xx

in CEM1: $\phi 1,98 - 2,00$ mm (.0780 - .0787)

in FR4: $\phi 1,99 - 2,01$ mm (.0783 - .0791)

Electrical data

Current rating (at room temp.): max. 20 A with spring force $\geq 1,5$ N and BeCu plunger (***) spring force $< 1,5$ N not recommended for high current applications)

R_i typical: < 10 m Ω

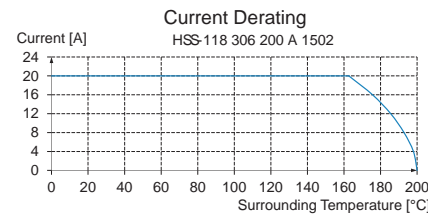
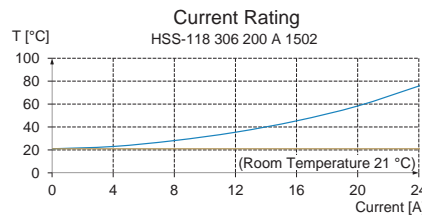

Mechanical data

Working stroke: 4,0 mm (.157)

Maximum stroke: 5,3 mm (.209) for tip styles with diameter ≤ 1 mm (.039)

Maximum stroke: 8,0 mm (.315)

Spring force at work. stroke: 1,5 N (5.4oz)

Alternative: 0,8 N (2.9oz)***; 2,25 N (8.1oz); 3,0 N (10.8oz)

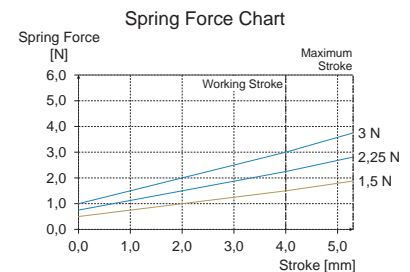

Ordering example

Series Tip material Tip style Tip diameter (1/100 mm) Plating Spring force (dN) Collar height (mm)

2 = Steel
3 = BeCu A = Gold
S = silver

Test probe:

H S S 1 1 8 3 0 6 2 0 0 A 1 5 0 2

Receptacles:

K S - 1 1 2 2 3 K S - 1 1 2 3 0 K S - 1 1 2 3 0 E 2 / E 5

Grid:
≥ 2,54 mm
≥ 100 Mil

Installation height with KS: 10,5 mm (.413)
Recommended stroke: 4,0 mm (.157)

Mounting and functional dimensions

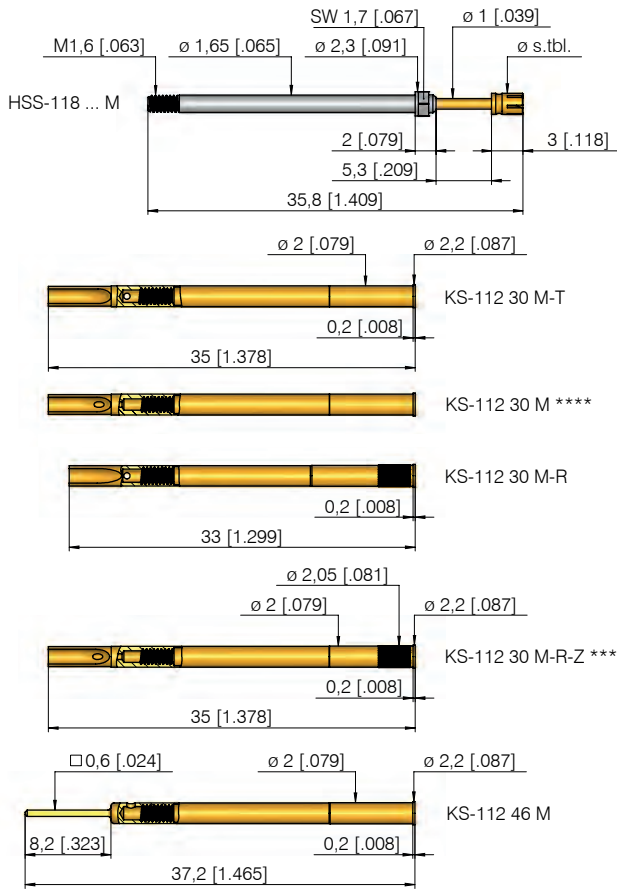

Available tip styles

Material	Tip style	Plating	Further versions	
			ϕ	ϕ (inch)
3 02		A		
3 03		A		
3 05		A	0,65	(.026)
3 05		A		
3 05**		S		
3 06		A	1,30 1,60 1,80 2,50 3,50	(.051) (.063) (.070) (.098) (.138)
2 14		A		
3 17		A	2,00	(.079)
3 19		A		
3 53***		S		

** pressed-on silver head
*** pressed-on silver head; tip length 3,5 mm (.138), installation height plus 0,5 mm (.020)

**** axially positioned through-hole for leakage test. Attention: when not assembled correctly, then solder can flow inside the receptacle.

Compatible GKS

GKS-112 M (assembled in same receptacle)

Materials

Plunger: BeCu or steel, gold-plated
Barrel: Brass, silver-plated
Spring: Stainless steel, gold-plated
Receptacle: Brass, gold-plated

Operating temperature

Standard: -100° up to +200° C

Mounting hole size

for KS-112 xx M
in CEM1 and FR4: ϕ 1,98 - 1,99 mm (.0780 - .0783)

for KS-112 xx M-R/M-R-Z
in CEM1 and FR4: ϕ 2,00 - 2,02 mm (.0787 - .0795)

Recommended screw-in torque

Min. 3 cNm / Max. 5 cNm

Electrical data

Current rating (at room temp.): max. 20 A with spring force \geq 1,5 N and BeCu plunger (***) spring force $<$ 1,5 N not recommended for high current applications)

R_j typical: $<$ 10 m Ω

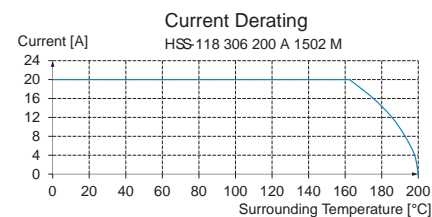
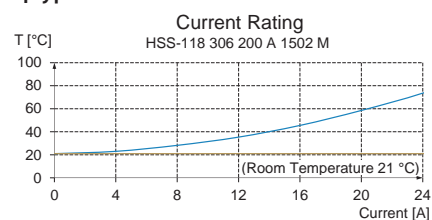

Mechanical data

Working stroke: 4,0 mm (.157)
Maximum stroke: 5,3 mm (.209) for tip styles with diameter \leq 1 mm (.039)
Maximum stroke: 8,0 mm (.315)
Spring force at work. stroke: 1,5 N (5.4oz)
Alternative: 0,8 N (2.9oz)***; 2,25 N (8.1oz); 3,0 N (10.8oz)

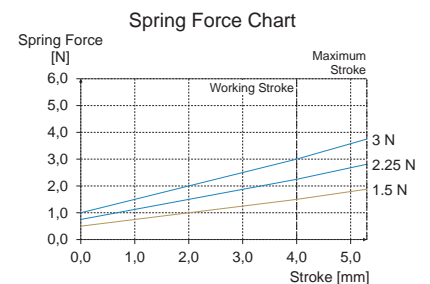

Ordering example

Series	Tip material 2 = Steel 3 = BeCu	Tip style	Tip diameter (1/100 mm)	Plating A = Gold S = Silver	Spring force (dN)	Collar height (mm)	Type
Test probe:	HSS	118	306	200	A	1502	M
Receptacles:	KS-11230M / M-R / M-T / M-R-Z			KS-11246M			

HSS 120

High Current Probe up to 30 A
Plug-in Test Probe

Grid:

≥ 4,00 mm

≥ 160 Mil

Installation height with KS: 10,5 / 13,5 / 18,5 mm (.413 / .531 / .728)

Recommended stroke: 4,0 mm (.157)

Mounting and functional dimensions

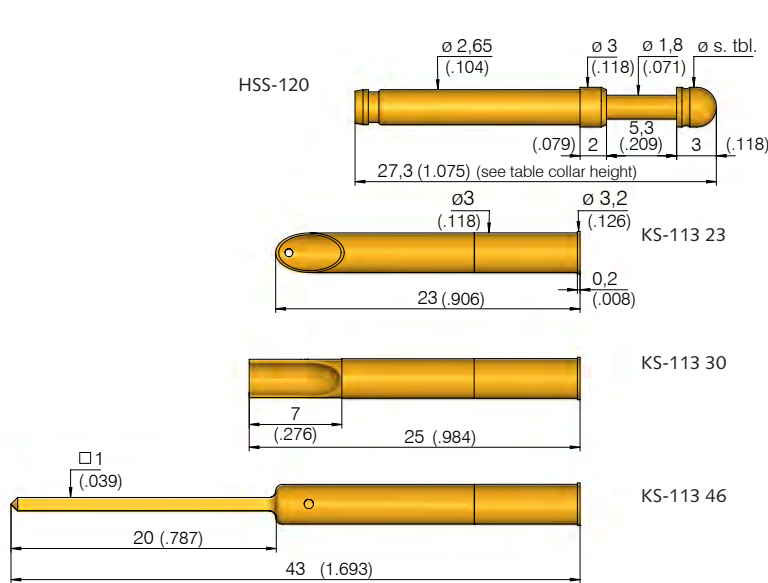

Collar height	02	05	10
Total length (mm)	27,3	30,3	35,3
Installation height without receptacle (mm)	10,3	13,3	18,3

Available tip styles

Material	Tip style	Plating	Further versions	
			∅	∅ (inch)
3 02		A	4,00	(.157)
3 03		A		
3 05		A		
3 05		A	3,00	(.118)
3 05**		S		
3 06		A	3,00 4,00	(.118) (.157)
3 17		A		
3 19		A		
2 51*		A		
3 53***		S		
3 55*		A		

* tip length 5 mm (.197) - installation height with collar height 02: 12,5 mm (.492)
 ** pressed-on silver tip
 *** pressed-on silver tip, tip length 3,5 mm (.138) installation height plus 0,5 mm (.020)

Compatible GKS

GKS-113 (assembled in same receptacle)

Materials

Plunger: BeCu or steel, gold-plated
Barrel: Brass, silver-plated
Spring: Stainless steel, gold-plated
Receptacle: Brass, gold-plated

Operating temperature

Standard: -100° up to +200° C

Mounting hole size

for KS-113 xx:
 in CEM1 and FR4: ∅ 2,98 - 2,99 mm (.1173 - .1177)

Electrical data

Current rating (at room temp.): max. 30 A with spring force ≥ 1,5 N and BeCu plunger (**** spring force < 1,5 N not recommended for high current applications)
R_i typical: < 10 mΩ

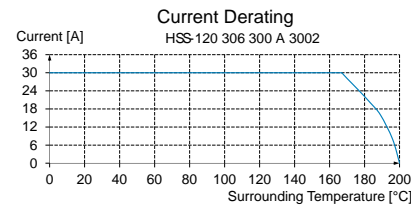
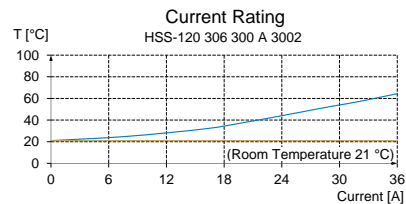

Mechanical data

Working stroke: 4,0 mm (.157)
Maximum stroke: 5,3 mm (.209)
Spring force at work. stroke: 1,5 N (5.4oz)
Alternative: 1,0 N (3.6oz) ****; 2,25 N (8.1oz); 3,0 N (10.8oz)

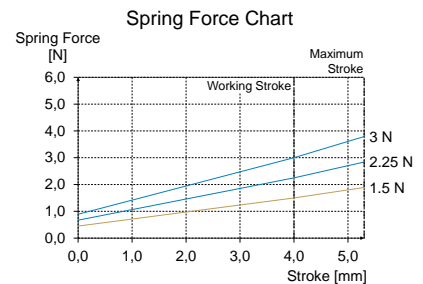

Ordering example

Series Tip material Tip style Tip diameter (1/100 mm) Plating Spring force (dN) Collar height (mm)

2 = Steel 3 = BeCu A = Gold S = Silver

Test probe:

H S S 1 2 0 3 0 6 3 0 0 A 1 5 0 2

Receptacles:

K S - 1 1 3 3 0 K S - 1 1 3 2 3 K S - 1 1 3 4 6

Grid:
≥ 4,00 mm
≥ 160 Mil

Installation height with KS: 10,5 mm (.413)
Recommended stroke: 4,0 mm (.157)

Mounting and functional dimensions

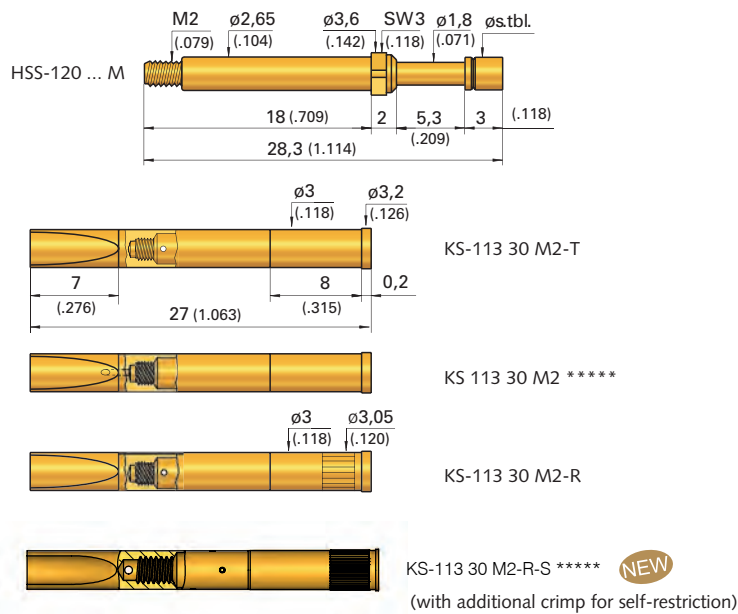

***** axially positioned through-hole for leakage test.
Attention: when not assembled correctly, then solder can flow inside the receptacle.

Available tip styles

Material	Tip style	Plating	Further versions	
			ϕ	ϕ (inch)
3 02		A	4,00	(.157)
3 03		A		
3 05		A		
3 05		A	3,00	(.118)
3 05***		S		
3 06		A	3,00 4,00	(.118) (.157)
3 17		A		
3 19		A		
2 51**		A		
3 53**		S		
3 55**		A		

** tip length 5 mm (.197) - installation height with collar height 02: 12,5 mm (.492)
 *** pressed-on silver tip
 **** pressed-on silver tip, tip length 3,5 mm (.138) installation height plus 0,5 mm (.020)

Materials

Plunger: BeCu or steel, gold-plated
Barrel: Brass, silver-plated
Spring: Stainless steel, gold-plated
Receptacle: Brass, gold-plated

Electrical data

Current rating (at room temp.): max. 30 A with spring force $\geq 1,5$ N and BeCu plunger (*spring force $< 1,5$ N not recommended for high-current applications)
R_j typical: < 10 m Ω

Mechanical data

Working stroke: 4,0 mm (.157)
Maximum stroke: 5,3 mm (.209)
Spring force at work. stroke: 1,5 N (5.4oz)
Alternative: 1,0 N* (3.6oz); 2,25 N (8.1oz); 3,0 N (10.8oz)

Operating temperature

Standard: -100° up to +200° C

Mounting hole size

for **KS-113 30 M2 / M2-T**
 in **CEM1:** ϕ 2,98 - 3,00 mm (.1173 - .1183)
 in **FR4:** ϕ 2,99 - 3,01 mm (.1177 - .1185)
 for **KS-113 30 M2-R / M2-R-S**
 in **CEM1 and FR4:** ϕ 3,00 - 3,02 mm (.1181 - .1189)

Recommended screw-in torque

Min. 10 cNm / Max. 20 cNm

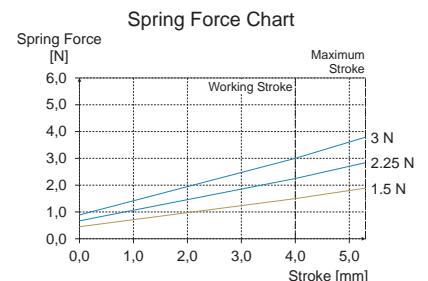
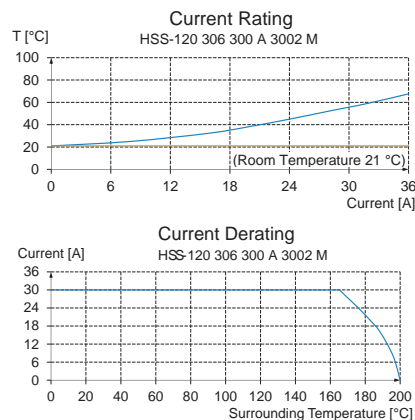

Ordering example

Series	Tip material 2 = Steel 3 = BeCu	Tip style	Tip diameter (1/100 mm)	Plating A = Gold S = Silver	Spring force (dN)	Collar height (mm)	Type
Test probe:	HSS	120	306	300	A	1502	M
Receptacles:	KS-11330M2/M2-T		KS-11330M2-R/M2-R-S				

HSS 150

High Current Probe up to 50 A
Plug-in Test Probe

Grid:

≥ 5,08 mm

≥ 200 Mil

Installation height with KS: 10,8 mm (.425)

Recommended stroke: 4,4 mm (.173)

Mounting and functional dimensions

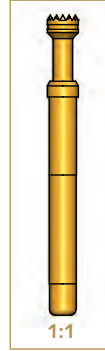
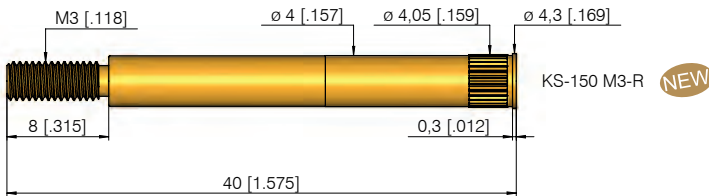
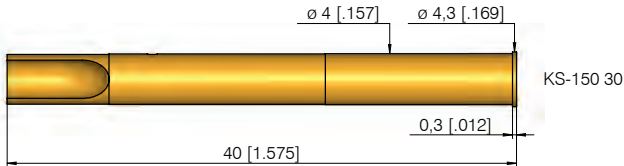
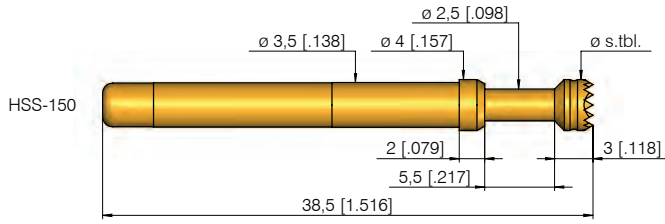

Available tip styles

Material	Tip style	Plating	Further versions	
			∅	∅ (inch)
3 02		A	∅ 4,00 (.157)	
3 03		A	∅ 4,00 (.157)	
3 05*		S	∅ 4,00 (.157)	
3 06		A	∅ 4,00 (.157)	3,00 (.118)
3 17		A	∅ 3,00 (.118)	
3 19		A	∅ 4,00 (.157)	

* pressed-in silver stud

Compatible GKS

GKS-854 (assembled in same receptacle)

Materials

Plunger: BeCu, gold-plated or silver stud
Barrel: Brass, silver-plated
Spring: Stainless steel, gold-plated
Receptacle: Brass, gold-plated

Operating temperature

Standard: -100° up to +200° C

Mounting hole size

for KS-150:
in CEM1 and FR4: ∅ 3,98 - 3,99 mm (.1567 - .1571)

for KS-150 M3-R:
in CEM1 and FR4: ∅ 4,00 - 4,02 mm (.1575 - .1583)

Electrical data

Current rating (at room temp.): max. 50 A
R_j typical: < 10 mΩ

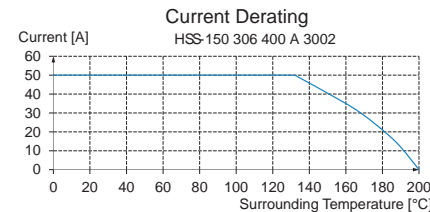
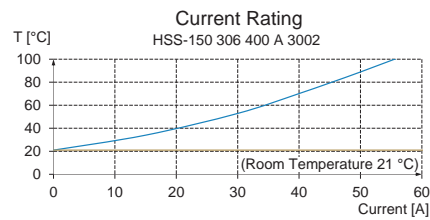

Mechanical data

Working stroke: 4,4 mm (.173)
Maximum stroke: 5,5 mm (.217)
Spring force at work. stroke: 3,0 N (10.8oz)
Alternative: 5,0 N (18.1oz); 10 N (36 oz) ("99" in order number)

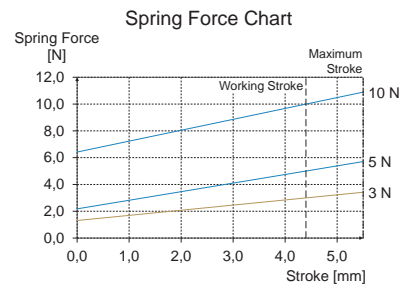

Ordering example

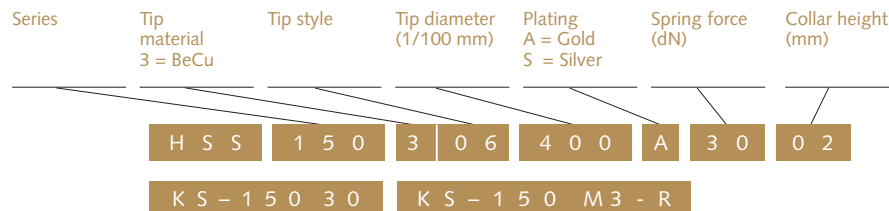

Grid:
≥ 5,08 mm
≥ 200 Mil

Installation height with KS: 10,8 mm (.425)
Recommended stroke: 4,4 mm (.173)

Mounting and functional dimensions

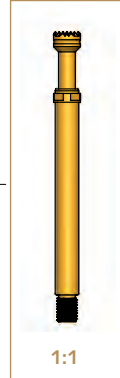
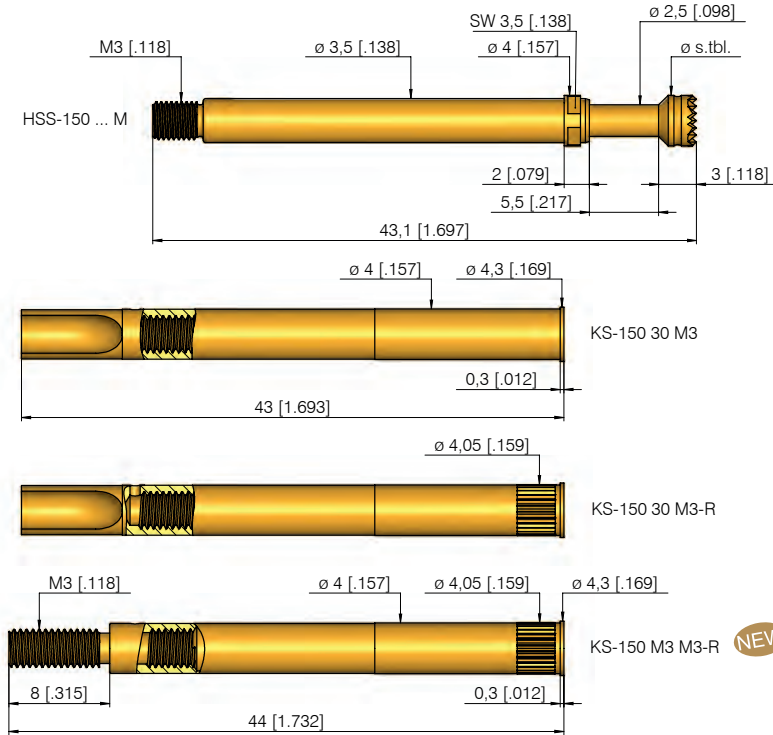

Available tip styles

Material	Tip style	Plating	Further versions	
			ϕ	ϕ (inch)
3 02		A		
3 03		A		
3 05*		S		
3 06		A	3,00	(.118)
3 17		A		
3 19		A		

* pressed-in silver stud

Compatible GKS

GKS-854 M (assembled in same receptacle)

Materials

Plunger: BeCu, gold-plated or silver stud
Barrel: Brass, silver-plated
Spring: Stainless steel, gold-plated
Receptacle: Brass, gold-plated

Operating temperature

Standard: -100° up to +200° C

Mounting hole size

for **KS-150 30 M3** in CEM1 and FR4: ϕ 3,99 mm (.1571)
for **KS-150 30 M3-R + KS-150 M3 M3-R** in CEM1 and FR4: ϕ 4,00 - 4,02 mm (.1575 - .1583)

Recommended screw-in torque

Min. 10 cNm / Max. 20 cNm

Electrical data

Current rating (at room temp.): max. 50 A
(for short loads up to 80 A)

R_i typical: < 10 m Ω

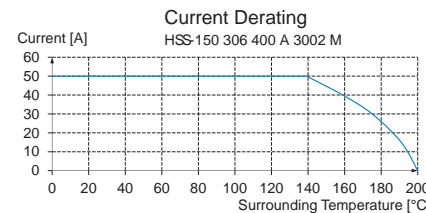
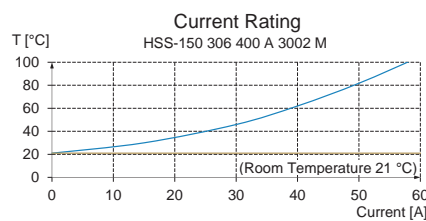

Mechanical data

Working stroke: 4,4 mm (.173)

Maximum stroke: 5,5 mm (.217)

Spring force at work. stroke: 3,0 N (10.8oz)

Alternative: 5,0 N (18.1oz);

10 N (36oz) ("99" in order number)

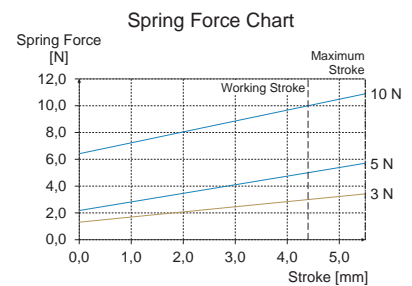

Ordering example

Series Tip material Tip style Tip diameter (1/100 mm) Plating A = Gold S = Silver Spring force (dN) Collar height (mm) Type

Test probe:

H S S 1 5 0 3 0 6 4 0 0 A 3 0 0 2 M

Receptacles:

K S - 1 5 0 3 0 M 3 K S - 1 5 0 3 0 M 3 - R K S - 1 5 0 M 3 M 3 - R

HSS 621 M

High Current Probe up to 75 A
Plug-in Test Probe

NEW

Grid:

≥ 6,35 mm

≥ 250 Mil

Installation height with KS: 10,8 mm (.425)

Recommended stroke: 4,4 mm (.173)

Mounting and functional dimensions

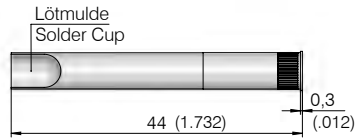
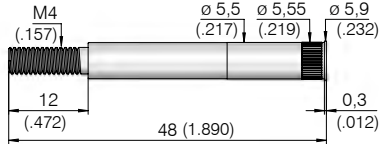
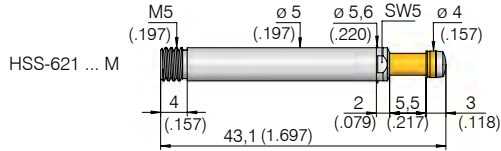

KS-621 M4 M5-R

KS-621 30 M5-R

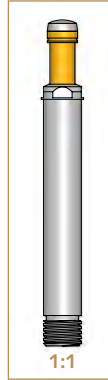

Available tip styles

Material	Tip style	Plating	Further versions	
			Ø	Ø (inch)
3 05*		S	Ø 4,00 (.157)	
3 06		A	Ø 5,00 (.197)	

* pressed-in silver stud

Materials

Plunger: BeCu, gold-plated or silver stud
Barrel: Brass, silver-plated
Spring: Stainless steel
Receptacle: Brass, gold-plated

Operating temperature

Standard: -100° up to +200° C

Mounting hole size

for KS-621 xx M5-R
in CEM1 and FR4: Ø 5,50 - 5,52 mm (.2165 - .2173)

Recommended tightening torque

HSS-621 M in KS-621: 40 cNm
Cable at KS-621: 2 Nm
Solder connection KS-621
for cable with wire cross section: ≤ 10 mm²

Electrical data

Current rating (at room temp.): max. 75 A
R_j typical: < 5 mΩ

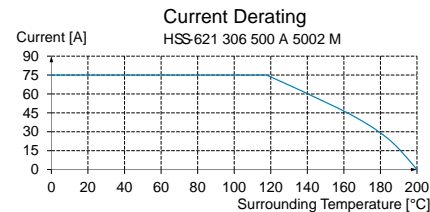
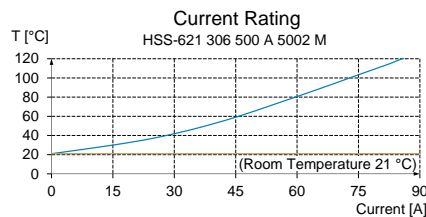

Mechanical data

Working stroke: 4,4 mm (.173)
Maximum stroke: 5,5 mm (.217)
Spring force at work. stroke: 5,0 N (18.1oz)
Alternative: 10,0 N (36oz)

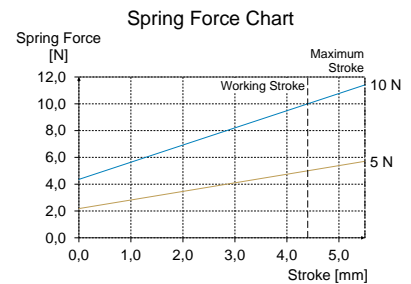

Ordering example

Series	Tip material	Tip style	Tip diameter (1/100 mm)	Plating	Spring force (dN)	Collar height (mm)	Type
	3 = BeCu			A = Gold S = Silver			
Test probe:	HSS	621	306	500	A	50	02 M
Receptacles:	KS-621	M4 M5-R	KS-621	30 M5-R			

NEW

HSS 623 M

High Current Probe up to 100 A
Screw-in Test Probe

Grid:
≥ 7,60 mm
≥ 300 Mil

Installation height with KS: 10,8 mm (.425)
Recommended stroke: 4,4 mm (.173)

Mounting and functional dimensions

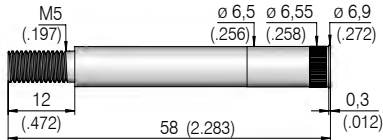
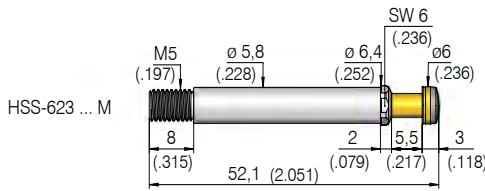

KS-623 M5 M5-R

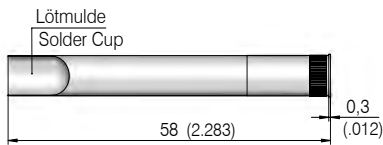

KS-623 30 M5-R



Available tip styles

Material	Tip style	Plating	Further versions	
			∅	∅ (inch)
3	05*	S	∅ 6,00 (.236)	
3	06	A	∅ 6,00 (.236)	

* pressed-in silver stud

Materials
Plunger: BeCu, gold-plated or silver stud
Barrel: Brass, silver-plated
Spring: Stainless steel
Receptacle: Brass, gold-plated

Operating temperature
Standard: -100° up to +200° C

Mounting hole size
for KS-623 xx M5-R
in CEM1 and FR4: ∅ 6,50 - 6,52 mm (.2559 - .2567)

Recommended tightening torque
HSS-623 M in KS-623: 40 cNm
Cable at KS-623: 4 Nm
Solder connection KS-623
for cable with wire cross section: ≤ 16 mm²

Electrical data
Current rating (at room temp.): max. 100 A
R_i typical: < 5 mΩ

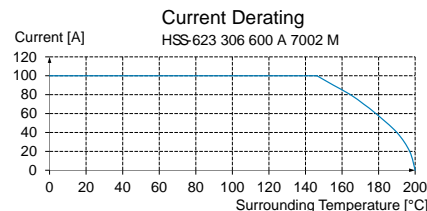
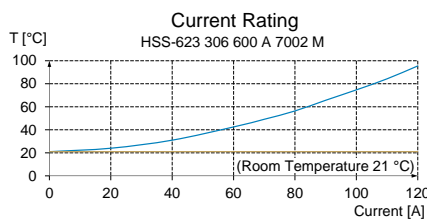

Mechanical data
Working stroke: 4,4 mm (.173)
Maximum stroke: 5,5 mm (.217)
Spring force at work. stroke: 7,0 N (25.2oz)
Alternative: 10,0 N (36oz); 15,0 N (54oz)

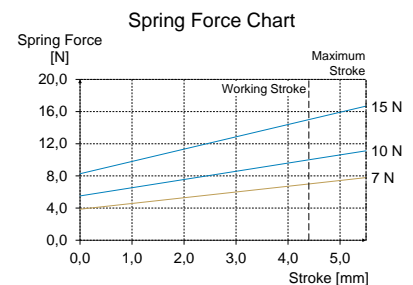

Ordering example

Series Tip material Tip style Tip diameter (1/100 mm) Plating (A = Gold, S = Silver) Spring force (dN) Collar height (mm) Type

Test probe:
Receptacles:



HSS 827 M

High Current Probe up to 20 A
Screw-in Test Probes

Grid:
≥ 2,54 mm
≥ 100 Mil

Installation height with KS: 8,7 mm (.343)
Recommended stroke: 3,5 mm (.138)

Mounting and functional dimensions

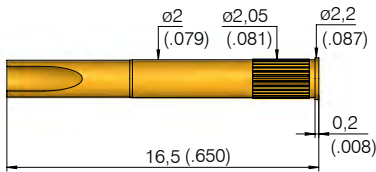
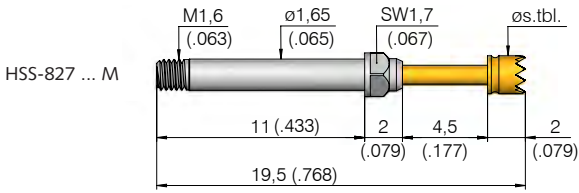

KS-427 30 M-R

Available tip styles

Material	Tip style	Plating	Further versions	
			∅	∅ (inch)
3	02* 	S	∅ 2,00 (.079)	
3	06 	A	∅ 2,00 (.079)	

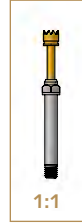

* pressed-in silver stud

Compatible GKS

GKS-427 M (assembled in same receptacle)

Materials

Plunger: BeCu, gold-plated or silver stud
Barrel: Brass, silver-plated
Spring: Stainless steel, gold-plated
Receptacle: Brass, gold-plated

Operating temperature

Standard: -100° up to +200° C

Mounting hole size

for KS-427 30 M-R
in CEM1 and FR4: ∅ 2,00 - 2,02 mm
(.0787 - .0795)

Recommended screw-in torque

Min. 3 cNm / Max. 5 cNm

Electrical data

Current rating (at room temp.): max. 20 A
R_j typical: < 10 mΩ

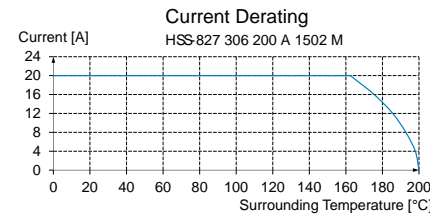
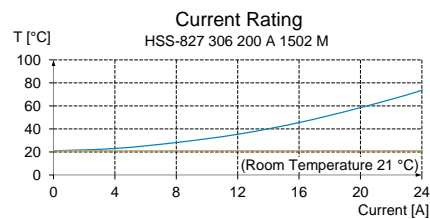

Mechanical data

Working stroke: 3,5 mm (.138)
Maximum stroke: 4,5 mm (.177)
Spring force at work. stroke: 1,5 N (5.4oz)
Alternative: 2,5 N (9.0oz)

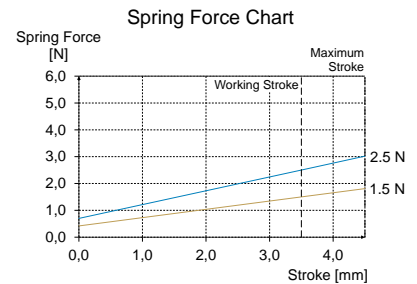

Ordering example

Series	Tip material	Tip style	Tip diameter (1/100 mm)	Plating	Spring force (dN)	Collar height (mm)	Type
	3 = BeCu			A = Gold S = Silver			

Test probe:

H S S 8 2 7 3 0 6 2 0 0 A 1 5 0 2 M

Receptacle:

K S - 4 2 7 3 0 M - R

HSS 520/HSS 520 M

High Current Probe up to 30 A
Short-stroke Test Probes to Plug in and Screw in

Grid:
≥ 4,0 mm
≥ 160 Mil

Installation height with KS: 7,4 mm (.291)
Recommended stroke: 2,8 mm (.110)

Mounting and functional dimensions

HSS-520

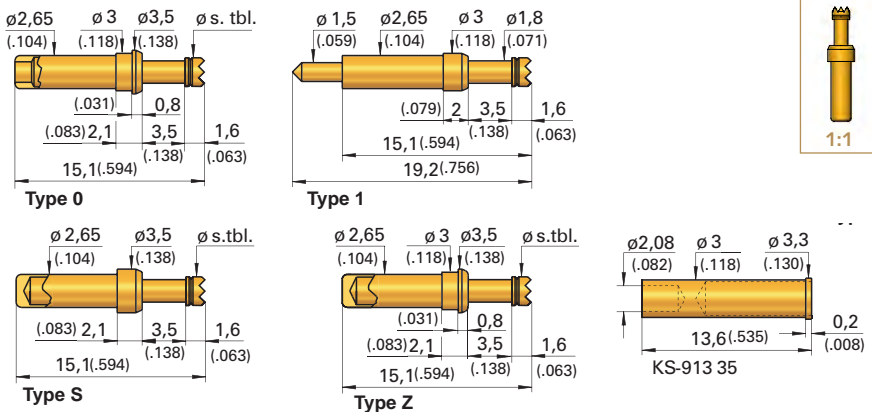

Available tip styles

Material	Tip style	Plating	Further versions	
			∅	∅ (inch)
3	06	A	3,50	(.138)

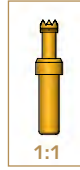

HSS-520 ... M

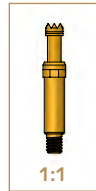
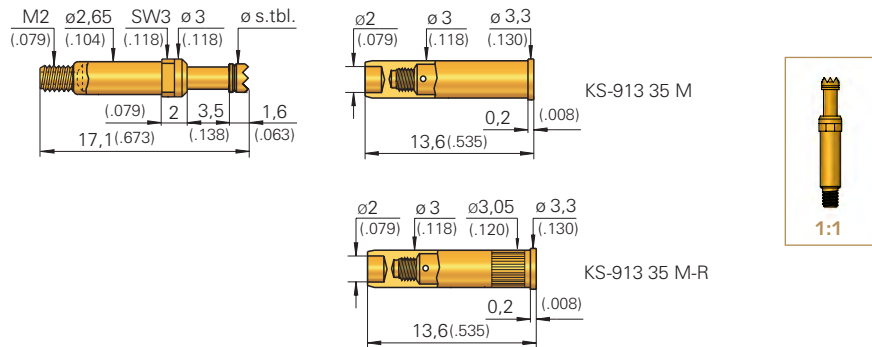

Compatible GKS

GKS-913 (plug-in version)
GKS 913 M (screw-in version)

Materials

Plunger: BeCu, gold-plated
Barrel: Brass, gold-plated
Spring: Stainless steel, gold-plated
Receptacle: Brass, gold-plated

Operating temperature

Standard: -100° up to +200° C

Mounting hole size

for KS-913 35 and KS-913 35 M
in CEM1 and FR4: ∅ 2,98 - 2,99 mm
(.1173 - .1177)

for KS-913 35 M-R
in CEM1 and FR4: ∅ 3,00 - 3,02 mm
(.1181 - .1189)

Electrical data

Current rating (at room temp.): max. 30 A
R_j typical: < 20 mΩ

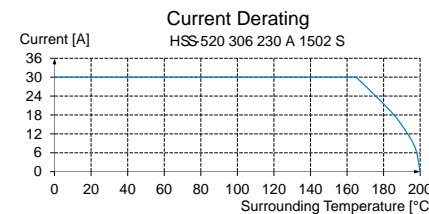
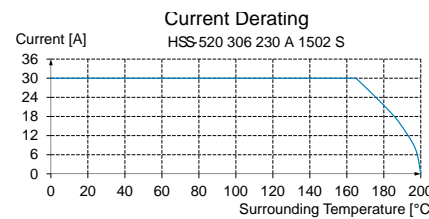

Mechanical data

Working stroke: 2,8 mm (.110)
Maximum stroke: 3,5 mm (.138)
Spring force at work. stroke: 1,5 N (5.4oz)

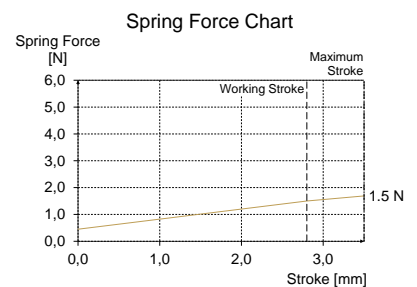

Ordering example

Series Tip material Tip style Tip diameter (1/100 mm) Plating Spring force (dN) Collar height (mm) Type

Test probe:

H S S 5 2 0 3 0 6 2 3 0 A 1 5 0 2 M

Receptacles:

K S - 9 1 3 3 5 K S - 9 1 3 3 5 M K S - 9 1 3 3 5 M - R

HSS 552 M

High Current Probe up to 50 A
Short-stroke Test Probes to Screw-in

Grid:

≥ 5,08 mm

≥ 200 Mil

Installation height with KS: 7,5 mm (.295)

Recommended stroke: 2,0 mm (.079)

Mounting and functional dimensions

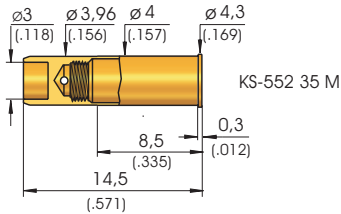
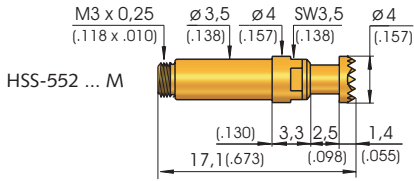

Available tip styles

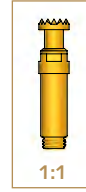

Material	Tip style	Plating	Further versions	
			∅	∅ (inch)
3 02		A	∅ 4,00 (.157)	
3 06		A	∅ 4,00 (.157)	

Materials

Plunger: BeCu, gold-plated
Barrel: Brass, gold-plated
Spring: Stainless steel
Receptacle: Brass, gold-plated

Operating temperature

Standard: -100° up to +200° C

Mounting hole size

for KS-552 35 M
in CEM1 and FR4: ∅ 3,99 mm (.1571)
for KS-150 30 M3-R
in CEM1 and FR4: ∅ 4,00 - 4,02 mm (.1575 - .1583)

Recommended screw-in torque

Min. 10 cNm / Max. 20 cNm

Electrical data

Current rating (at room temp.): max. 50 A
R_i typical: < 10 mΩ

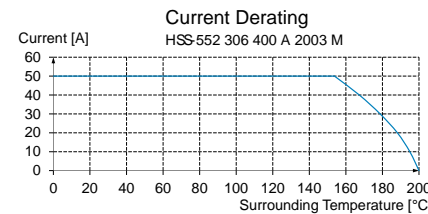
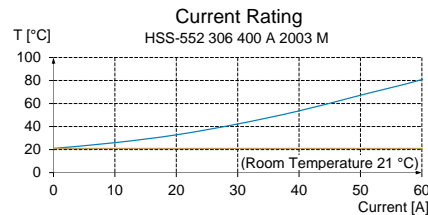

Mechanical data

Working stroke: 2,0 mm (.079)
Maximum stroke: 2,5 mm (.098)
Spring force at work. stroke: 2,0 N (7.2oz)

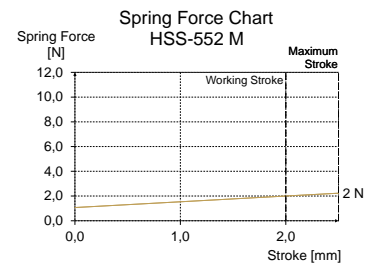

Ordering example

Series	Tip material	Tip style	Tip diameter (1/100 mm)	Plating	Spring force (dN)	Collar height (mm)	Type
	3 = BeCu			A = Gold			M
Test probe:	H S S	5 5 2	3 0 6	4 0 0	A	2 0	0 3 M
Receptacle:	K S - 5 5 2 3 5 M						

Grid:
 ≥ 5,08 mm
 ≥ 200 Mil

Installation height with KS: 13,8 mm (.543)
 Recommended stroke: 7,4 mm (.291)

High Current Probe up to 50 A
 Long-stroke Test Probes to Plug in and Screw in

Mounting and functional dimensions

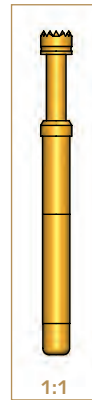
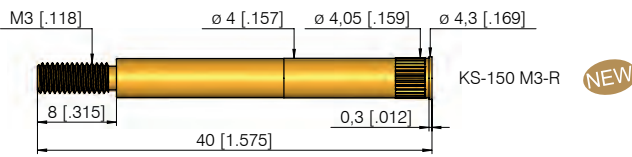
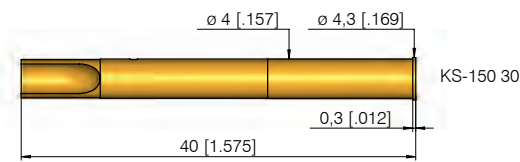
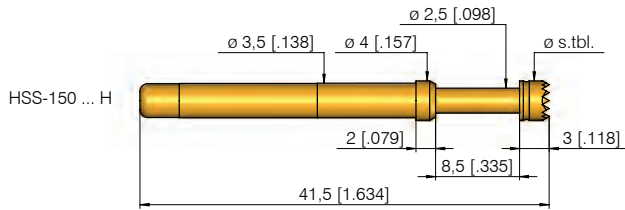

Available tip styles

Material	Tip style	Plating	Further versions	
			∅	∅ (inch)
3 02		A		
3 05*		S		
3 06		A		
3 17		A		

Total length 46,1 mm (1.815), special designation "MH"
 * pressed-in silver stud

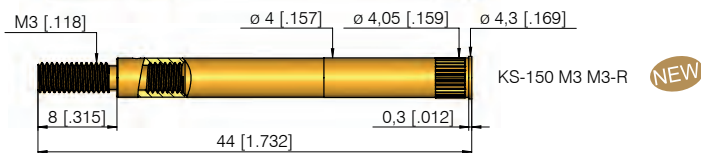
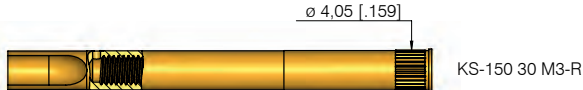
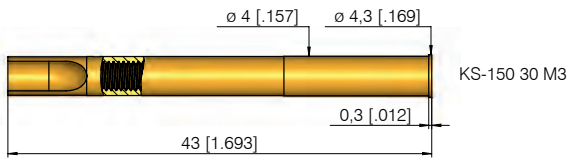
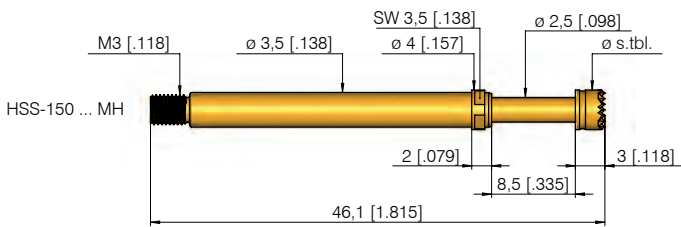

Materials

Plunger: BeCu, gold-plated
Barrel: Brass, gold-plated
Spring: Stainless steel
Receptacle: Brass, gold-plated

Mechanical data

Working stroke: 7,4 mm (.291)
Maximum stroke: 8,5 mm (.335)
Spring force at work. stroke: 3,0 N (10.8oz)
Alternative: 5,0 N (18.1oz);
 10 N (36oz) ("99" in order number)

HSS-150 MH

Mounting hole size

for KS-150 30 in CEM1 and FR4: ∅ 3,98 - 3,99 mm (.1570 - .1571)
for KS-150 30 M3 in CEM1 and FR4: ∅ 3,99 mm (.1571)

Electrical data

Current rating (at room temp.): max. 50 A
R_j typical: < 10 mΩ

Operating temperature

Standard: -100° up to +200° C

for KS-150 M3-R + KS-150 30 M3-R +

KS-150 M3 M3-R in CEM1 and FR4: ∅ 4,00 - 4,02 mm (.1575 - .1583)

Recommended screw-in torque

Min. 10 cNm / Max. 20 cNm

Ordering example

Series	Tip material	Tip style	Tip diameter (1/100 mm)	Plating	Spring force (dN)	Collar height (mm)	Type "H", "MH"
	3 = BeCu			A = Gold S = Silver			

Test probe HSS-150 ... H:

H S S 1 5 0 3 0 6 4 0 0 A 3 0 0 2 H

Receptacles for HSS-150 ... H:

K S - 1 5 0 3 0 K S - 1 5 0 M 3 - R

Test probe HSS-150 ... MH:

H S S 1 5 0 3 0 6 4 0 0 A 3 0 0 2 M H

Receptacles for HSS-150 ... MH:

K S - 1 5 0 3 0 M 3 K S - 1 5 0 3 0 M 3 - R K S - 1 5 0 M 3 M 3 - R

HSS 005

High Current Probe up to 40 A
Plug-in Test Probe

Grid:

≥ 4,75 mm

≥ 187 Mil

Installation height with KS: 16,5 mm (.650)

Recommended stroke: 4,4 mm (.173)

Mounting and functional dimensions

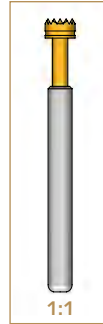
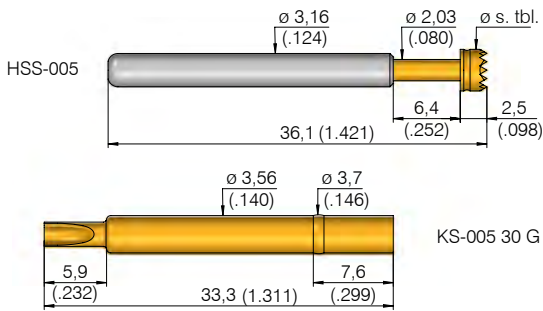

Available tip styles

Material	Tip style	Plating	Further versions	
			\varnothing	\varnothing (inch)
3 06		A	\varnothing 3,96 (.160)	
3 13		A	\varnothing 2,03 (.080)	

Materials

Plunger: BeCu, gold-plated
Barrel: Brass, gold-plated
Spring: Stainless steel
Receptacle: nickel-silver, silver-plated

Electrical data

Current rating (at room temp.): max. 40 A
R_i typical: < 5 m Ω

Mechanical data

Working stroke: 4,4 mm (.173)
Maximum stroke: 6,35 mm (.250)
Spring force at work. stroke: 3,0 N (10.8oz)
Alternative: 5,0 N (18.1oz)

Operating temperature

Standard: -100° up to +200° C

Mounting hole size

With collar or press ring as a collar-stop in CEM1 and FR4: \varnothing 3,53 - 3,54 mm (.1378 - .1399)

When pressing the press ring into the mounting hole in CEM1 and FR4: \varnothing 3,58 - 3,63 mm (.1409 - .1429)

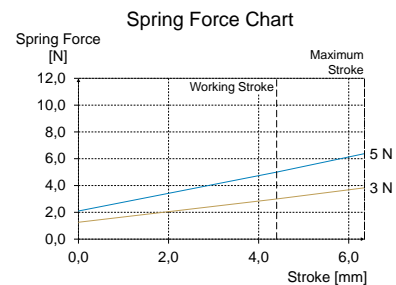
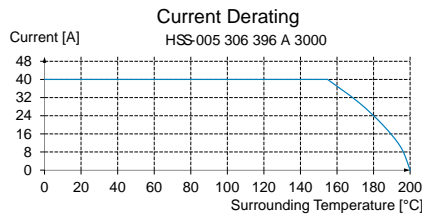
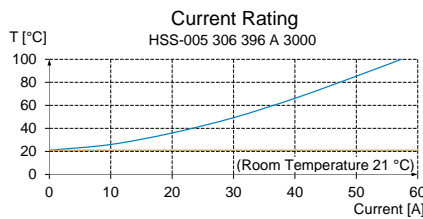

Ordering example

Series	Tip material 3 = BeCu	Tip style	tip diameter (1/100 mm)	Plating A = Gold	Spring force (dN)	Collar height (mm)
HSS	005	3	06	396	A	30
KS-005 30 G						

Test probe:

Receptacle:

Dipole HSS High Current Clamps Robust HSS

Dipole high current probes (Kelvin probes) are used to perform four-wire measurements directly on the contact surface. In doing so, the voltage on the inner conductor and the current on the outer conductor are measured. This enables precise resistance measurement on accumulators or flat connector blades (the resistance of the measurement cable is not part of the measurement).

Dipole high current probes either have a coaxial design with central inner conductor, or are four-wire clamps with galvanic insulated spring clips.

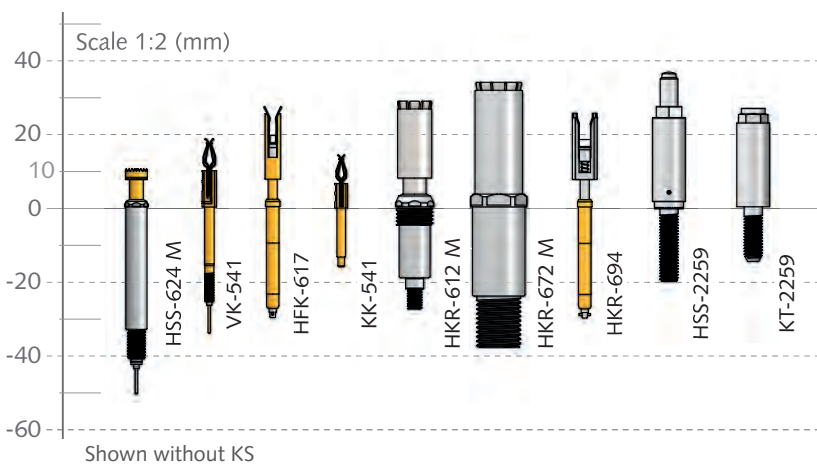

The high current clamp series **HKR** and **HKF** enable secure, scratch free contacting of round posts and flat connector blades using contact lamellae. The lamellae close only once the unit under test has reached the base of the high current clamp. The high current clamp for round contacts are especially recommended for round contacts which cannot be contacted on their top side due to protection covers. In challenging test conditions with vibrations and longer test cycles, high current clamps are ideally suited thanks to their robust design.

Robust high current test probes stand out due to their sturdy design and are ideally suited for challenging atmospheric conditions with side forces and vibrations present. They are also suitable as a permanently assembled element in machinery. In combination with available contact terminals, interface blocks or transmission contacts can be created.

Dipole High Current Probes Four-wire Clamp

HSS-624 M	NEW	92
VK-541	NEW	93

High Current Clamp (flat/round)

HKF-617	NEW	94
KK-541	NEW	95
HKR-612 M	NEW	96
HKR-672 M	NEW	97
HKR-694	NEW	98

Robust High Current Probes (probe/contact terminal)

HSS-2259	99
HSS-2513	99
HSS-2516	99
HSS-2526	99
HSS-2532	99

Note:

See page 76 for overview and comparison table.

HSS 624 M

Dipole Probe up to 100 A

NEW

Grid:

≥ 7,60 mm

≥ 300 Mil

Installation height with KS: 10,8 mm (.425)

Recommended stroke: 4,4 mm (.173)

Mounting and functional dimensions

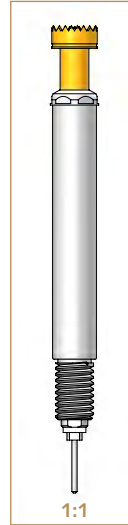
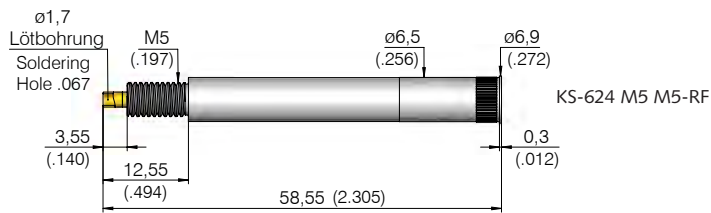
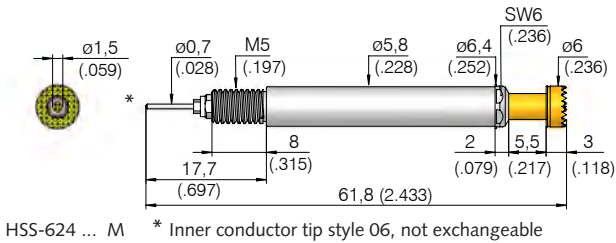

Note:

The new screw-in dipole probe HSS-624 M is a market-driven development for simultaneously transferring high currents and carrying out a voltage measurement directly on the contact pads (4 pole measurement).

Due to the design and the small internal resistance, currents of up to 100 A can be safely and reliably transferred in small spaces. (grid size 300 Mil = 7,6 mm (.299).

Materials

Plunger:	BeCu, gold-plated
Barrel:	Brass, silver-plated
Spring:	Stainless steel
Receptacle:	Brass, silver-plated

Electrical data

Current rating (at room temp.)	
- outer conductor:	max. 100 A
- inner conductor:	max. 1 A
R _i typical outer conductor:	< 5 mΩ
R _i typical inner conductor:	< 20 mΩ

Mechanical data

Working stroke:	4,4 mm (.173)
Max. stroke:	5,5 mm (.217)
Spring-force at work. stroke:	9,0 N (32.5oz)

Operating temperature

Standard: -100° up to +200° C

Mounting hole size

for KS-624 in CEM1 and FR4: ø 6,50 - 6,52 mm (.2559 - .2567)

Recommended tightening torque

HSS-624 M in KS-624: 40 cNm
Cable at KS-624: 2 Nm

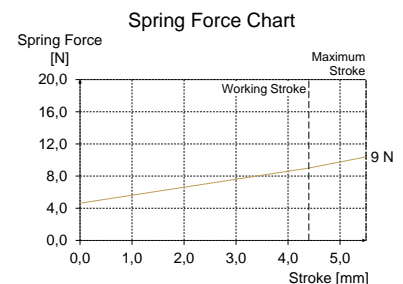
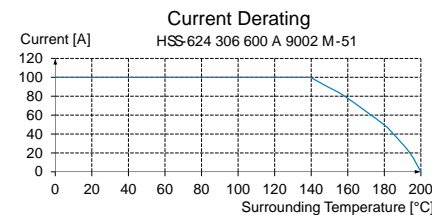
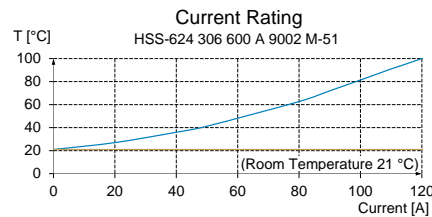

Ordering example

Series	Tip material 3 = BeCu	Tip style	Tip diameter (1/100 mm)	Plating A = Gold S = Silver	Spring force (dN)	Collar height (mm)	Type
--------	--------------------------	-----------	----------------------------	-----------------------------------	----------------------	-----------------------	------

Test probe:

H S S 6 2 4 3 0 6 6 0 0 A 9 0 0 2 M - 5 1

Receptacle for HSS-624 M:

K S - 6 2 4 M 5 M 5 - R F

NEW

VK 541

Four-wire Clip up to 10 A

Grid:
 ≥ 3,50 mm
 ≥ 140 Mil

Installation height with KS: 19,1 mm (.752)
 Recommended stroke: 5,0 mm (.197)

Mounting and functional dimensions

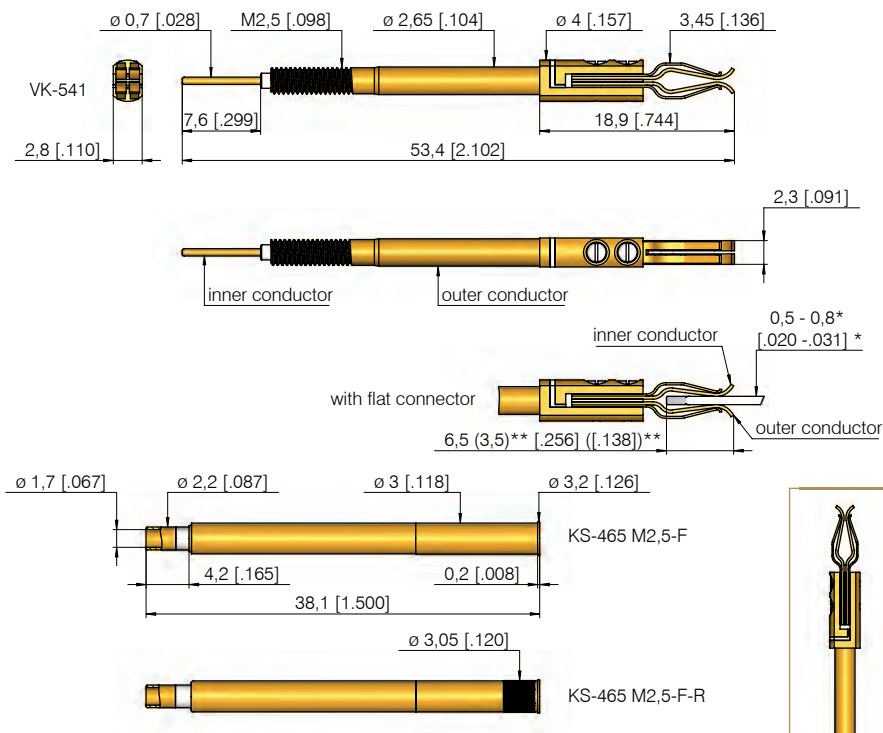

Note:

The **VK-541** is a four-wire version of the original **KK-541** contact clip. In addition to the reliable contacting of flat connectors on the outer surface, the **VK-541** enables a four-wire measurement. Hence, the voltage can be measured directly on the contacting area thus determining the resistance.

Due to the double spring clip, the **VK-541** is ideal for harsh test conditions i.e. vibrations, contamination, and longer testing cycles.

Materials

Spring clip: BeCu, gold-plated
 Barrel: Brass, gold-plated
 Receptacle: Brass, gold-plated

Electrical data

Current rating (at room temp.)
 - outer conductor: max. 10 A
 - inner conductor: max. 1 A
 R_i typical outer conductor: < 5 mΩ
 R_i typical inner conductor: < 10 mΩ

Flat connector to be contacted

Min. length: 3,5 mm (.138)
 Thickness flat connector*: 0,5 - 0,8 mm (.020 - .031)

Operating temperature

Standard: -100° up to +200° C

Mounting hole size

for **KS-465 M2,5-F** in CEM1 and FR4: ∅ 2,98 - 2,99 mm (.1173 - .1177)
 for **KS-465 M2,5 F-R**: ∅ 3,00 - 3,02 mm (.1181 - .1189)

Recommended Screw-in torque

VK-541 in **KS-465**: 3 cNm

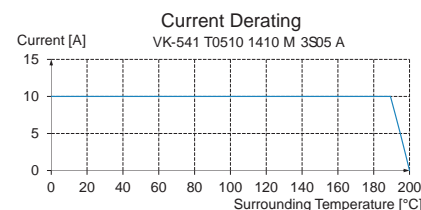
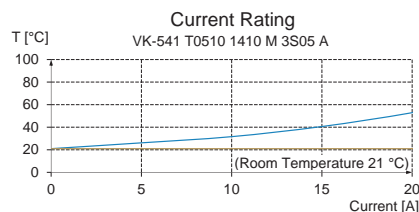

Mechanical data

Min. immersion depth**: 3,5 mm (.138)
 Max. immersion depth**: 6,5 mm (.256)

Dipole HSS
Robust HSS

Ordering example

Four-wire clip:

V K 5 4 1 T 0 5 1 0 1 4 1 0 M 3 S 0 5 A

Receptacle for VK-541:

K S - 4 6 5 M 2, 5 - F K S - 4 6 5 M 2, 5 - F - R

HKF 617

Scratch-free Contacting
of Flat Connectors up to 40 A

NEW

Grid:
≥ 5,50 mm
≥ 220 Mil
Installation height with KS: 27,9 mm (1.098)
Recommended stroke: 4,4 mm (.173)

Mounting and functional dimensions



HKF-617 032 08 080 A 10002
(for flat connectors 2,8 - 3,2 mm width)

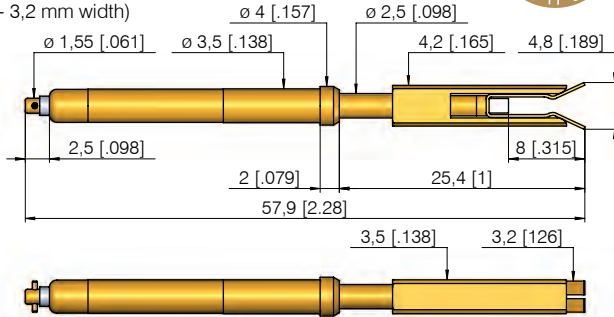

HKF-617 063 08 080 A 10002
(for flat connectors 4,8 - 6,3 mm width)

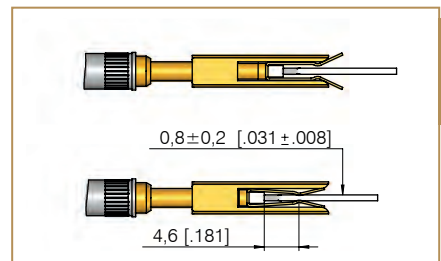
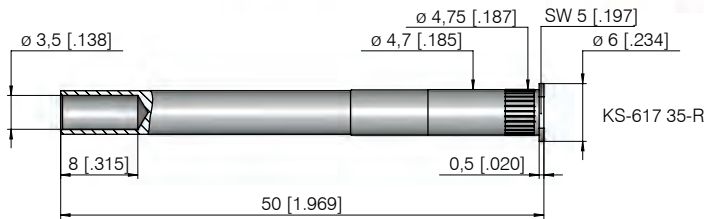
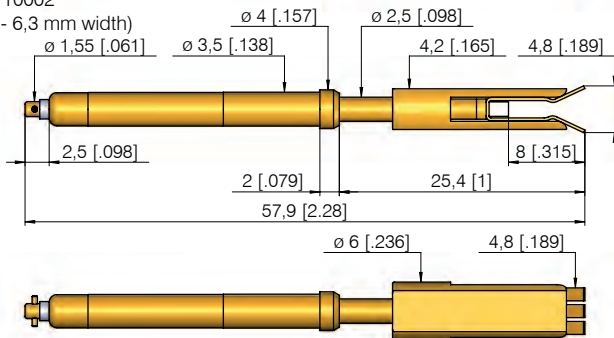

Note:

The high current clip HKF-617 enables secure contacting of flat connectors of 20 to 40 A. During the contacting process, the contact lamellae are pressed onto the flat connectors without scratching them.

Materials

Spring clip: Bronze, gold-plated
Barrel: Brass, gold-plated
Receptacle: Brass, gold-plated

Electrical data

Current rating (at room temp.):
HKF-617 032: max. 20 A
HKF-617 064: max. 40 A
R_j typical: < 5 mΩ

Flat connector to be contacted

Min. length: 9,0 mm (.354)
Thickness flat connector: 0,8 ± 0,2 mm (.031 ± .008)

Operating temperature

Standard: -100° up to +150° C

Mounting hole size

for KS-617 35-R
in CEM1 and FR4: ∅ 4,68 - 4,72 mm (.1840 - .1860)

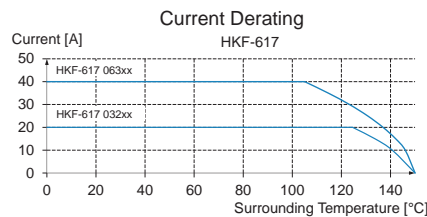
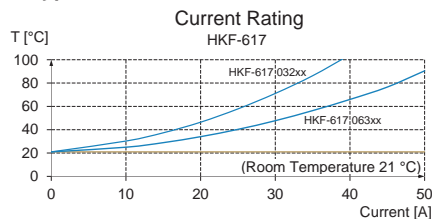

Mechanical data

Min. immersion depth: 8,0 mm (.315)
Working stroke: 4,4 mm (.173)
Max. stroke: 5,5 mm (.217)
Spring-force at work. stroke: 10 N (35.97oz)

Ordering example

Series	Width (1/10 mm)	Thickness flat connector (1/10 mm)	Immersion depth (1/10 mm)	Plating A = Gold	Spring force (dN)	Collar height (mm)
High current clamp (width 2,8 - 3,2 mm):	H K F	6 1 7	0 3 2	0 8	0 8 0	A 1 0 0 0 2
High current clamp (width 4,8 - 6,3 mm):	H K F	6 1 7	0 6 3	0 8	0 8 0	A 1 0 0 0 2
Receptacle:	K S - 6 1 7 3 5 - R					

NEW

KK 541

Contact Clip up to 20 A
Clip to Press-in and Screw-in

Grid:
≥ 3,50 mm
≥ 140 Mil

Installation height with KS: 16,6 mm (.654)
Recommended stroke: 5,0 mm (.197)

Mounting and functional dimensions

KK-541 to screw-in

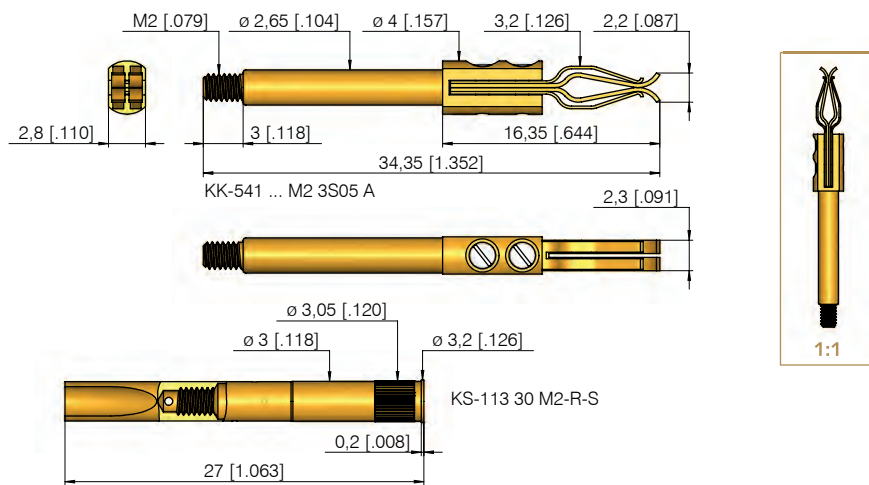

KK-541 to press-in

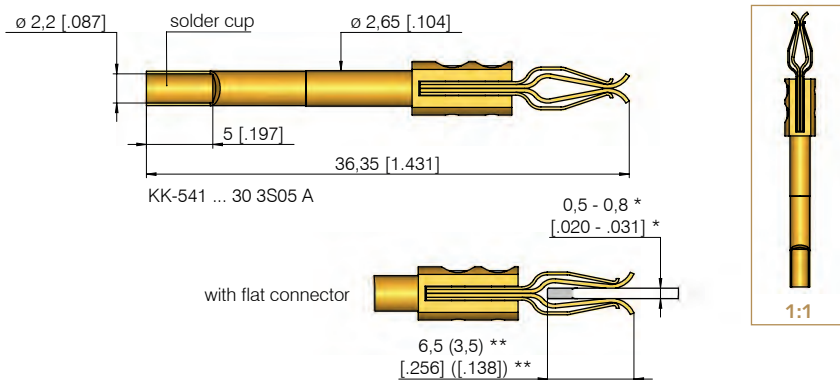

Note:

The contact clip **KK-541** offers reliable contacting of flat connectors on the outer surface. Even under harsh testing conditions with vibrations, contamination, and longer test cycles, the **KK-541** proves to be most suitable due to its double spring clip design.

Materials

Spring clip: BeCu, gold-plated
Barrel: Brass, gold-plated
Receptacle: Brass, gold-plated

Electrical data

Current rating (at room temp.): max. 20 A
R_j typical: < 5 mΩ

Flat connector to be contacted

Min. length: 3,5 mm (.138)
Thickness flat connector*: 0,5 - 0,8 mm (.020 - .031)

Operating temperature

Standard: -100° up to +200° C

Mounting hole size

for KS-113 30 M2-R-S in CEM1 and FR4: ø 3,00 - 3,02 mm (.1181 - .1189)
for KK-541 to press-in: ø 2,64 mm (.1043)

Recommended tightening torque

KK-541 in KS-113: 10 cNm

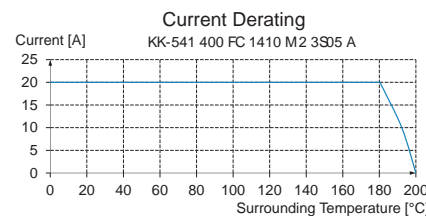
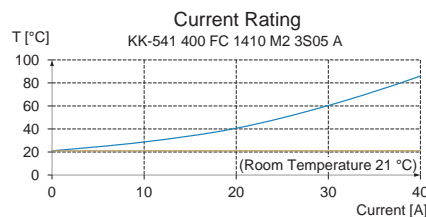

Mechanical data

Min. immersion depth:** 3,5 mm (.138)
Max. immersion depth:** 6,5 mm (.256)
Working stroke: 5,0 mm (.197)

Ordering example

Contact clip (for receptacle):

KK 541 400 FC 1410 M2 3S05 A

Contact clip (for press-fit):

KK 541 400 FC 1410 30 3S05 A

Receptacle:

KS-113 30 M2-R-S

HKR 612 M

High Current Clamps up to 100 A
for Round Post- \varnothing 3,0/4,0/6,0 mm

NEW

Grid:

$\geq 10,0$ mm
 ≥ 400 Mil

Installation height with KS: 29,5 mm (.1161)

Recommended stroke: 4,4 mm (.173)

Mounting and functional dimensions

HKR-612 300 100 S 10003 M
(for 3 mm tip diameter)

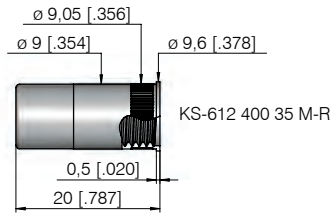
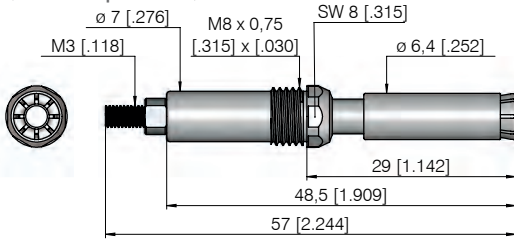

HKR-612 400 100 S 10003 M
(for 4 mm tip diameter)

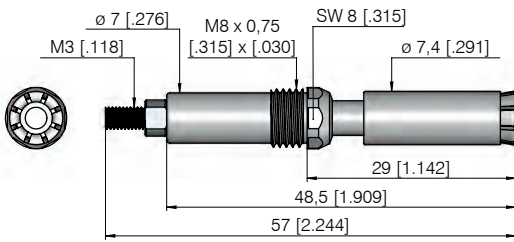

HKR-612 600 130 S 20003 M
(for 6 mm tip diameter)

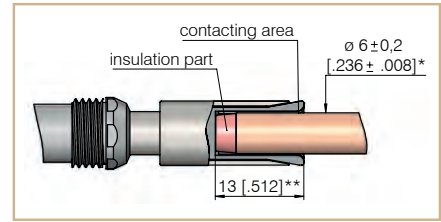
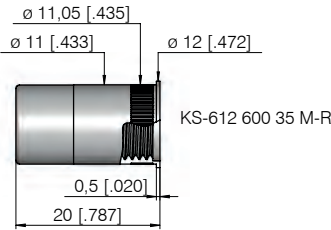
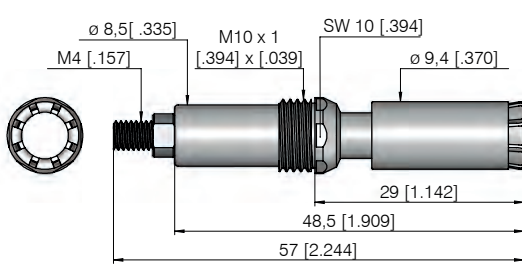

Example of contacting with HKR-612 600 ... M, \varnothing 6 mm

Note:

The high current clamps **HKR-612 M** enable the reliable contacting of round posts and threads up to 100 A. When contacting, the contact lamellas are pressed on the bolt without scratching it.

The high current clamps are especially recommended for round contacts with contact protection, which cannot be contacted from the top.

The **HKR-612 M** is also ideal for harsh testing conditions with vibrations, contamination and longer testing cycles because of its robust design.

Note:

High current clamps for further round post- \varnothing and immersion depth (round post lengths) upon request.

Materials

Plunger:	BeCu, silver-plated
Barrel:	Brass, silver-plated
Spring:	Stainless steel
Receptacle:	Brass, silver-plated

Operating temperature

Standard: -100° up to $+200^{\circ}$ C

Mounting hole size

for KS-612 400 35 M-R
in CEM1 and FR4: \varnothing 9,00 - 9,02 mm
(.3543 - .3551)

for KS-612 600 35 M-R
in CEM1 and FR4: \varnothing 11,00 - 11,02 mm
(.4331 - .4339)

Recommended tightening torque

HKR-612 M in KS-612 400 35 M-R: 50 cNm
Cable at HKR-612 300/400 ... M: 1 Nm
HKR-612 M in KS-612 600 35 M-R: 60 cNm
Cable at HKR-612 600 ... M: 2 Nm

Electrical data

Current rating (at room temp.)

HKR-612 300 ... M:	max. 35 A
HKR-612 400 ... M:	max. 50 A
HKR-612 600 ... M:	max. 100 A

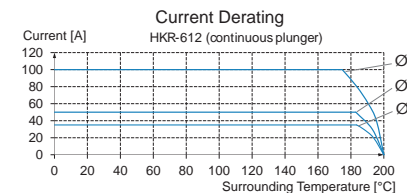
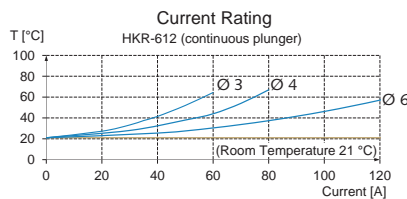

Round post to be contacted

for HKR-612 300/400 ... M

Min. immersion depth bolt**:	10 mm (.394)
Round post- \varnothing *:	3,0 mm \pm 0,2 mm (.118 \pm .008)
	4,0 mm \pm 0,2 mm (.157 \pm .008)

for HKR-612 600 ... M

Min. immersion depth bolt**:	13 mm (.512)
Round post- \varnothing *:	6,0 mm \pm 0,2 mm (.236 \pm .008)

Mechanical data

Immersion depth

HKR-612 300/400 ... M: **	10 mm (.394)
HKR-612 600 ... M: **	13 mm (.512)

Working stroke:	4,4 mm (.173)
Max. working stroke:	5,5 mm (.217)

Spring force at working stroke	
HKR-612 300/400 ... M:	10 N (36oz)
HKR-612 600 ... M:	20 N (72oz)

Ordering example

High current clamp (\varnothing 3 mm):

High current clamp (\varnothing 4 mm):

High current clamp (\varnothing 6 mm):

Receptacle for HKR-612 300/400 ... M:

Receptacle for HKR-612 600 ... M:

Series	Round post- \varnothing (1/100 mm)	Immersion depth (1/10 mm)	Plating S = Silver	Spring force (dN)	Collar height (mm)	Type
HKR	612	300	S	100	03	M
HKR	612	400	S	100	03	M
HKR	612	600	S	130	03	M
KS - 612 400 35 - M - R						
KS - 612 600 35 - M - R						

Grid:
 ≥ 18,00 mm
 ≥ 700 Mil

NEW

HKR 672 M

High Current Clamps
 for Round Post- \varnothing 8,0/10,0/12,0 mm

Installation height with KS: 33,5 mm (.1.319) - 34,7 mm (1.366)
 Recommended stroke: 4,0 mm (.157) respect. 4,4 mm (.173)

Mounting and functional dimensions

HKR-672 800 130 S 20004 M
 (for 8 mm tip diameter)

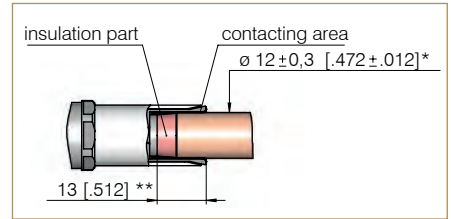
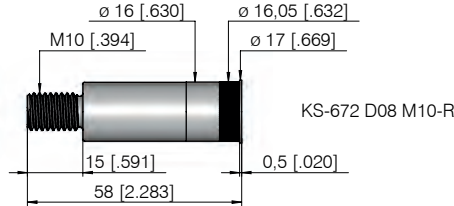
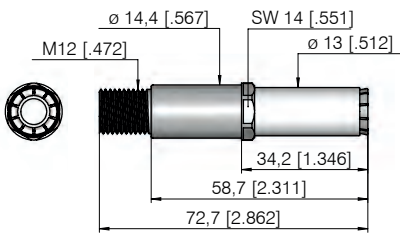

Example of contacting with HKR-672 ... M, \varnothing 12 mm

HKR-672 1000 130 S 20004 M
 (for 10 mm tip diameter)

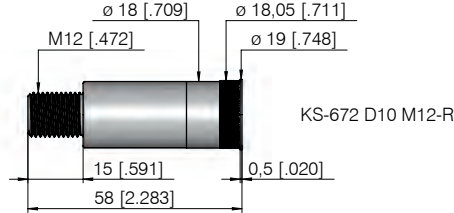
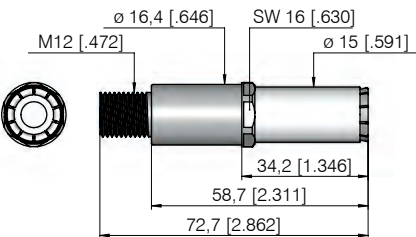

HKR-672 1200 130 S 20004 M
 (for 12 mm tip diameter)

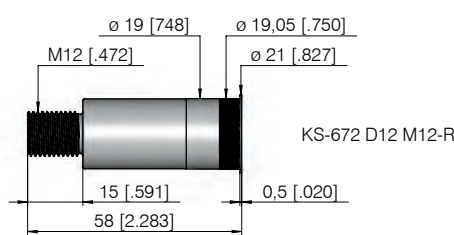
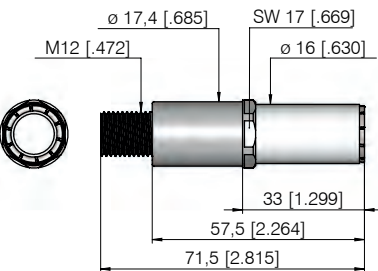

Note:

The high current clamps HKR-672 M enable the reliable contacting of round posts and threads. When contacting, the contact lamellas are pressed on the bolt without scratching it. The high current clamps are especially recommended for round contacts with contact protection, which cannot be contacted from the top.

The HKR-672 M are also ideal for harsh testing conditions with vibrations, contamination and longer testing cycles because of its robust design.

Note:

High current clamps for further round post- \varnothing and immersion depth (round post lengths) upon request.

Materials

Plunger: BeCu, silver-plated
 Barrel: Brass, silver-plated
 Spring: Stainless steel
 Receptacle: Brass, silver-plated

Operating temperature

Standard: -100° up to +200° C

Mounting hole size

in CEM1 and FR4

for KS-672 D08 M10-R: \varnothing 16,00 - 16,02 mm (.6299 - .6307)

for KS-672 D10 M12-R: \varnothing 18,00 - 18,02 mm (.7087 - .7094)

for KS-672 D12 M12-R: \varnothing 19,00 - 19,02 mm (.7480 - .7488)

Recommended tightening torque

HKR-672 M in KS-672: 2 Nm
 Cable at HKR-672 M: 2 Nm

Electrical data

Current rating (at room temp.): max. 200 A

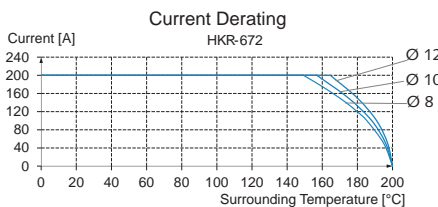
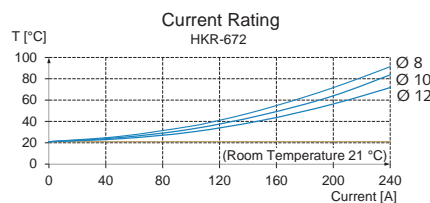

Round post to be contacted

Min. immersion depth bolt: ** 13 mm (.512)
 Round post- \varnothing : * 8,0 mm \pm 0,3 mm (.315 \pm .012)
 10,0 mm \pm 0,3 mm (.394 \pm .012)
 12,0 mm \pm 0,3 mm (.472 \pm .012)

Mechanical data

Min. immersion depth bolt: ** 13,0 mm (.512)

Working stroke

HKR-672 800: 4,0 mm (.157)
 HKR-672 1000: 4,0 mm (.157)
 HKR-672 1200: 4,4 mm (.173)
 Max. working stroke: 5,5 mm (.217)
 Spring force at work. stroke: 20 N (72oz)

Ordering example

	Series	Round post- \varnothing (1/100 mm)	Immersion depth (1/10 mm)	Plating S = Silver	Spring force (dN)	Collar height (mm)	Type
High current clamp (\varnothing 8 mm):	HKR	672	800	S	130	200	04 M
High current clamp (\varnothing 10 mm):	HKR	672	1000	S	130	200	04 M
High current clamp (\varnothing 12 mm):	HKR	672	1200	S	130	200	04 M
Receptacles:	KS - 672	D08	M10 - R		KS - 672	D10	M12 - R
	KS - 672	D12	M12 - R				

All specifications are subject to change without prior notification

HKR 694

High Current Clamps up to 15 A
for Round Post- \varnothing 4,0 mm

NEW

Grid:

$\geq 5,5$ mm

≥ 220 Mil

Installation height with KS: 26,2 mm (1.031)

Recommended stroke: 4,4 mm (.173)

Mounting and functional dimensions

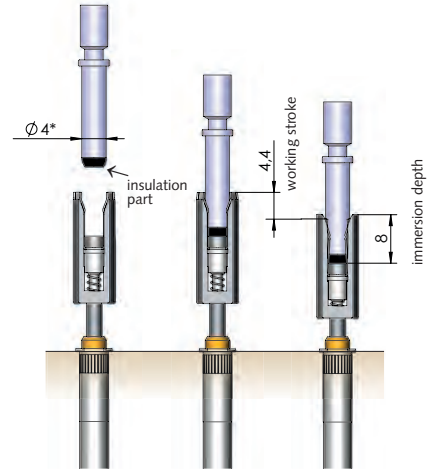
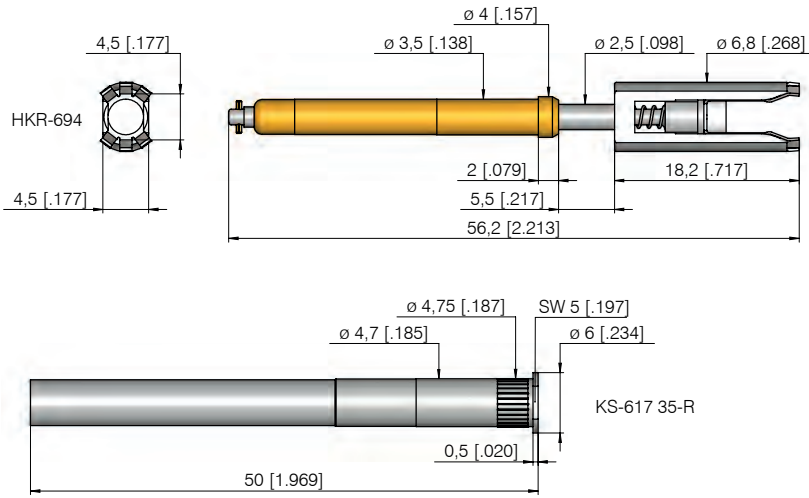

Contacting example HKR-694, \varnothing 4 mm

Note:

The high current clamp HKR-694 was developed for plug connectors with 4 mm nominal diameter which are arranged in a small grid size. Grid size of 5,5 mm is possible due to the combination of lamellae and slim base body.

Materials

Spring lamellae: bronze, silver-plated
Barrel: Brass, gold-plated
Spring: Stainless steel
Receptacle: Brass, silver-plated

Operating temperature

Standard: -100° up to +200° C

Mounting hole size

for KS-617 35-R
in CEM1 and FR4:
 \varnothing 4,68 mm (.184) - 4,72 mm (.186)

Electrical data

Current rating (at room temp.): max. 15 A

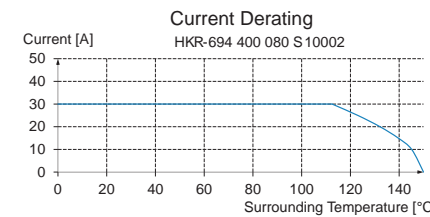
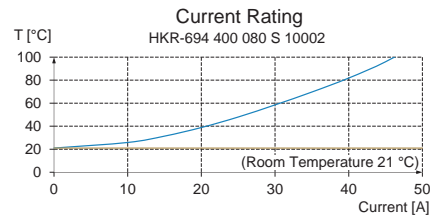

Round post to be contacted

Min. immersion depth bolt: 8 mm (.315)
Round post- \varnothing *: 4,0 mm \pm 0,2 mm (.157 \pm .008)

Mechanical data

Min. immersion depth bolt:** 8 mm (.315)
Working stroke: 4,4 mm (.173)
Max. working stroke: 5,5 mm (.217)
Spring force at working stroke: 10 N (36oz)

Ordering example

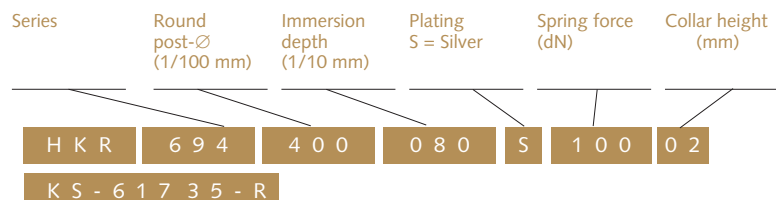

High current clamp:

Receptacle:

Installation heights: see drawings below
Recommended stroke: 7,0 mm (.276)

Mounting and functional dimensions

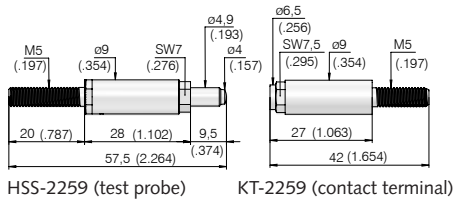

HSS-2259 (test probe) KT-2259 (contact terminal)

Electrical data

Max. current rating: 25 A
R_i typical: < 1 mΩ

Mechanical data

Working stroke: 7,0 mm (.276)
Maximum stroke: 9,5 mm (.374)
Spring force at work. stroke: 10 N (36oz)
Recommended tightening torque: 3 Nm

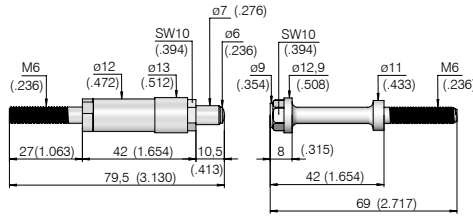
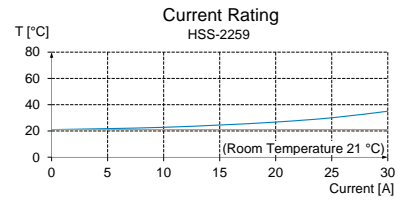

HSS-2513 (test probe) KT-2513 (contact terminal)

Electrical data

Max. current rating: 35 A
R_i typical: < 1 mΩ

Mechanical data

Working stroke: 7,0 mm (.276)
Maximum stroke: 10,5 mm (.413)
Spring force at work. stroke: 12 N (43.2oz)
Recommended tightening torque: 4 Nm

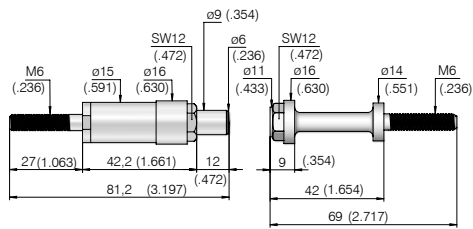
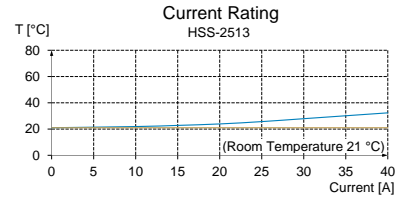

HSS-2516 (test probe) KT-2516 (contact terminal)

Electrical data

Max. current rating: 100 A
R_i typical: < 1 mΩ

Mechanical data

Working stroke: 7,0 mm (.276)
Maximum stroke: 12 mm (.472)
Spring force at work. stroke: 17 N (61.2oz)
Recommended tightening torque: 4 Nm

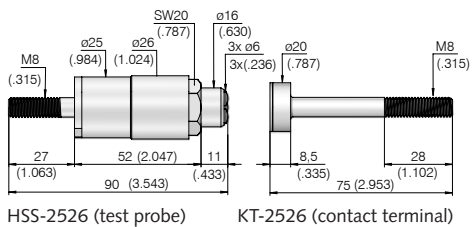
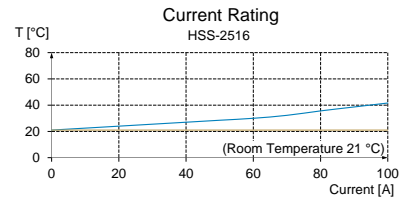

HSS-2526 (test probe) KT-2526 (contact terminal)

Electrical data

Max. current rating: 200 A
R_i typical: < 1 mΩ

Mechanical data

Working stroke: 7,0 mm (.276)
Maximum stroke: 11 mm (.433)
Spring force at work. stroke: 58 N (208.8oz)
Recommended tightening torque: 11 Nm

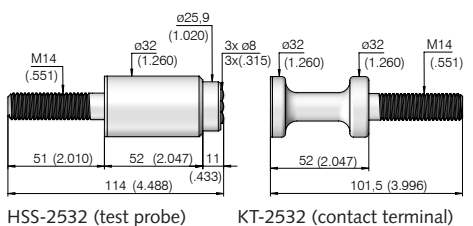
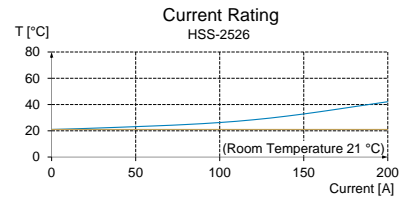

HSS-2532 (test probe) KT-2532 (contact terminal)

Electrical data

Max. current rating: 400 A
R_i typical: < 1 mΩ

Mechanical data

Working stroke: 7,0 mm (.276)
Maximum stroke: 11 mm (.433)
Spring force at work. stroke: 116 N (417.6oz)
Recommended tightening torque: 59 Nm

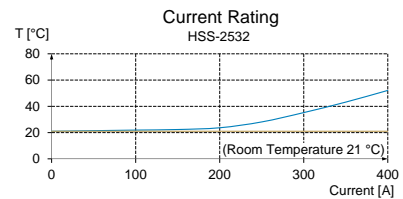

Materials

Plunger: Brass, silver-plated
silver plating on the contact surface
Barrel: Brass, silver-plated
Spring: Stainless steel

Operating temperature

Standard: +1° up to +80° C

The high current test probes HSS-2259 to HSS-2532 are designed for applications with high permanent currents. Their robust construction makes them equally suitable for harsh environmental and possible side loads.

Ordering example

Test probe:	HSS - 2259	HSS - 2513	HSS - 2516	HSS - 2526	HSS - 2532
Contact terminal:	KT - 2259	KT - 2513	KT - 2516	KT - 2526	KT - 2532

Switching Probes

Switching probes are suitable for many various applications: not only can they be used for component **detection tests** and switches for closed/open checks, but also as a signal trigger for process control. Furthermore, in combination with other test probes (e.g., push-back probes), position determination of contact terminals in plug housings is possible.

In most cases, INGUN switching probes are so-called “closers”, and are normally opened (NO). That means that the electric circuit is closed when the plunger is activated, allowing the plunger to be pushed further beyond the switching point. The rated current applied can only be transmitted in the closed state.

Press-in and **screw-in** versions are available, depending on installation requirements. These are also available as **quick-exchange systems** in most series. Screw-in versions are especially suitable for applications with vibrations or unwanted side forces or axial forces. This prevents the test probe moving out of the receptacle.

The electrical connection is made either by directly soldering on the receptacle (KS) and switching probe (SKS), using a plug, or a quick-exchange receptacle.

Various SKS applications

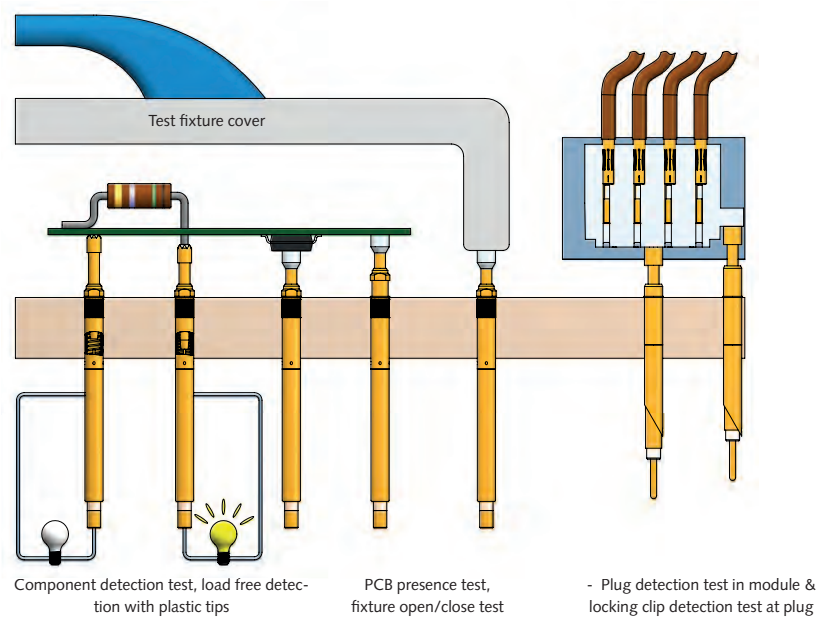

Type of installation	Type of receptacle	≥ 1.91 mm (≥ 75 Mil)	≥ 2.54 mm (≥ 100 Mil)	≥ 3.50 mm (≥ 140 Mil)	4.0 mm to 10.0 mm (160 Mil to 400 Mil)
Pressed into receptacle	Standard KS	NEW SKS-075	SKS-100 SKS-215	SKS-415 2 SKS-415 E SKS-425	SKS-419 SKS-429
	Quick-exchange KS	-	SKS-215 E	SKS-415 02 E	-
Screwed into receptacle	Standard KS	-	SKS-215 M	SKS-465 MF SKS-465 SF	SKS-435 M
	Quick-exchange KS	-	SKS-215 MF	NEW SKS-463 MF SKS-465 MF SKS-465 SF	NEW SKS-115 M
Page(s)		103	104 - 105 / 109	106 - 107 / 110 - 112	108 / 113 - 114

Suitable for a range of test requirements, a variety of different **switching probes (SKS)** are available. In most series, these probes act as a closer and are **normally open (NO)**. However, there are also openers, which are opened when the switching circuit is activated. These switches are **normally closed (NC)**.

The switching probes vary in terms of the following features: dimensions (grid size and length), switch path, working stroke, installation method (press-in or screw-in), and available tip styles.

With insulating plastic tip styles, voltage-free checks can be performed on components (here the signal is not sent through to the connection).

To regulate the **installation height**, various receptacle collar heights are available. Similarly, screw-in versions vary the installation height by means of a thread and allow the **position of the switch point to be precisely set**.

Switching probes are installed either by **pressing** or **screw-ing** them into the receptacle, for which both **standard receptacles and quick-exchange systems** are available.

The latter enables the switching probes to be changed quickly without new wiring. This results in reduced maintenance and less down time, and thus the costs associated with those. The wiring is done by the test equipment manufacturer only, thus preventing wiring errors during maintenance. The quick-exchange receptacles are also available with a knurl to ensure they are held securely in the bore hole over time.

For the **electrical connection**, a cable is always soldered on to the receptacle. The second cable is either soldered directly onto the inner conductor, connected using a plug, or the quick-exchange receptacle.

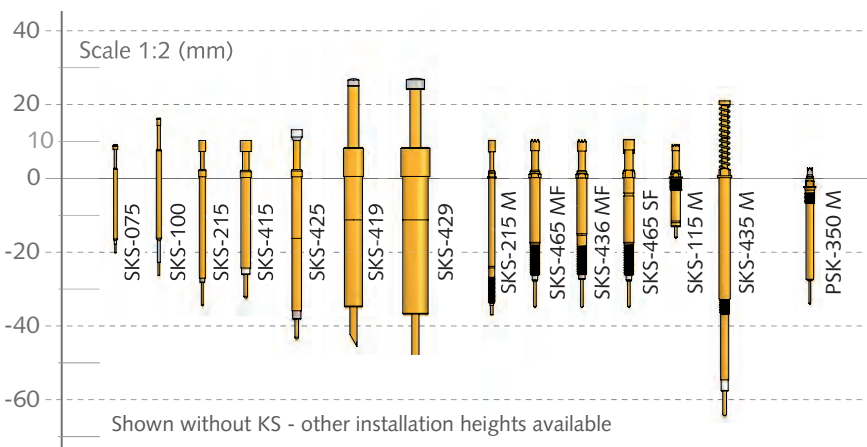

Switching Probes

Press-in Probes

SKS-075	NEW	103
SKS-100		104
SKS-215 (E*)		105
SKS-415 (E*)		106
SKS-425		107
SKS-419		108
SKS-429		108

Screw-in Probes

SKS-215 M/MF*		109
SKS-465 MF*		110
SKS-463 MF*	NEW	111
SKS-465 SF*		112
SKS-115 M*	NEW	113
SKS-435 M		114

Pneumatic PSK

PSK-350 M	173
-----------	-----

* SKS with quick exchange system

Note:

See next page for overview and comparison table.

Switching Probes Overview and Comparison

SKS probe version	Series	Grid size (≥ mm)	Working stroke (mm)	Max. stroke (mm)	Switch path (mm)	Current rating (A)	Spring forces at working stroke (N)		Installation height with receptacle (mm)		Shortest probe (mm)	Page
							min	max	min	max		
Press-in probes	NEW SKS-075	1.91	4	5	2.6	1	2	-	9.1	-	30	103
	SKS-100	2.54	5	6	4	3	2	-	16.4	19.1	43.4	104
	SKS-215 (E*)	2.54	4	5	1.5	3	0.8	3	10.2	-	44.6	105
	SKS-415 (E*)	3.5	4	5.2	1.7	5	2.3	-	10.4	24.9	42.5	106
	SKS-425	3.5	6.4	8	2.4	5	2.5	-	13.2	-	57.8	107
	SKS-419	7.5	11.2	14	2	5	5.2	-	27.3	-	74	108
	SKS-429	10	12.8	16	2	5	6.4	-	27.4	-	81	108
Screw-in probes	SKS-215 M/MF*	2.54	4	5	1.5	3	0.8	3	10.2	20	50.5	109
	SKS-465 MF*	3.5	4.2	5.2	1.7	3	2	9	10.4	26.7	44.8	110
	NEW SKS-463 MF*	3.5	4	5	1.7	3	2.2	-	10.4	26.7	44.8	111
	SKS-465 SF*	3.5	4.2	4.5	1.7	3	2	9	10.4	26.7	44.8	112
	NEW SKS-115 M*	4	4	5	1.7	3	1.5	3	9.2	-	25.2	113
	SKS-435 M	4.5	7	8	6	3	13.5	23.5	20.8	-	84	114
Pneumatic PSK	PSK-350 M	3.5	6	10	6	1-2	0.6	-	5.7	-	36.2	173

* SKS with quick exchange system

Quick-exchange receptacle for switching probes

To simplify the changing of switching probes, especially for maintenance, so-called *quick-exchange receptacles* are available for the most common series.

Advantages

- One-time wiring of the receptacle at the time of customising the test fixture or unit
- Insertion of the SKS from above (test fixture need not be opened)
- Reduction of the maintenance costs
- No wiring faults as a result of maintenance

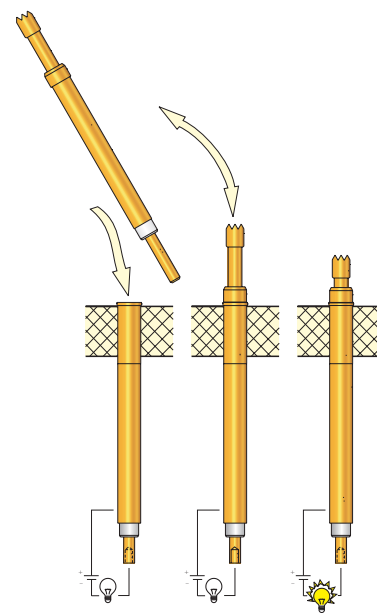

Grid:
≥ 1,91 mm
≥ 75 Mil

Installation height with KS: 9,1 mm (.279) / variable
Recommended stroke: 2,6 mm (.102)

Mounting and functional dimensions

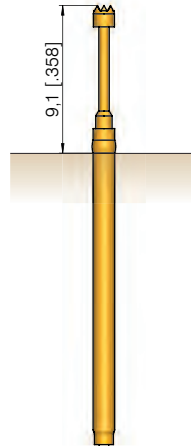
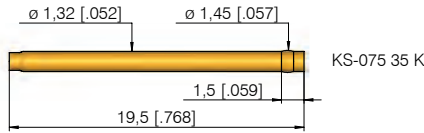
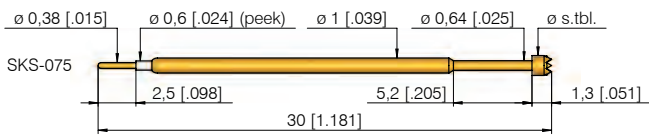

SKS-075 in
KS-075 35 K

Collar height and installation height

To adjust the installation height receptacles with a press ring are used. The receptacles can be inserted up to the press ring or with the press ring pressed into the mounting hole.

Mechanical data

Switch path: 2,6 mm (.102) ± 0,2 (.008)
Recomm. working stroke: 4,0 mm (.157)
Maximum stroke: 5,0 mm (.197)

Spring force at switch. point: 1,1 N (3.6oz)
Spring force at work. stroke: 2,0 N (7.2oz)

Electrical data

Current rating: 1 A

Operating temperature

Standard: -40° up to +80° C

Materials

Plunger: BeCu, gold-plated
Barrel: Bronze, gold-plated
Spring: Steel, gold-plated
Receptacle: Nickel-silver, gold-plated
Contact terminal: Brass, gold-plated
Insulator: Peek

Mounting hole size

when pressing the press ring into the mounting hole
in CEM1 and FR4: ∅ 1,36 - 1,40 mm (.054 - .055)

Press ring as a collar-stop

in CEM1: ∅ 1,30 - 1,31 mm (.051 - .052)
in FR4: ∅ 1,31 - 1,32 mm (.052 - .052)

Available tip styles

Material	Tip style	Plating	Further versions	
			∅	∅ (inch)
3	02	A	∅ 0,80 (.031)	
3	06	A	∅ 1,30 (.051)	

Warning:

Do not solder the cable to the crimp points of the receptacle.

Ordering example

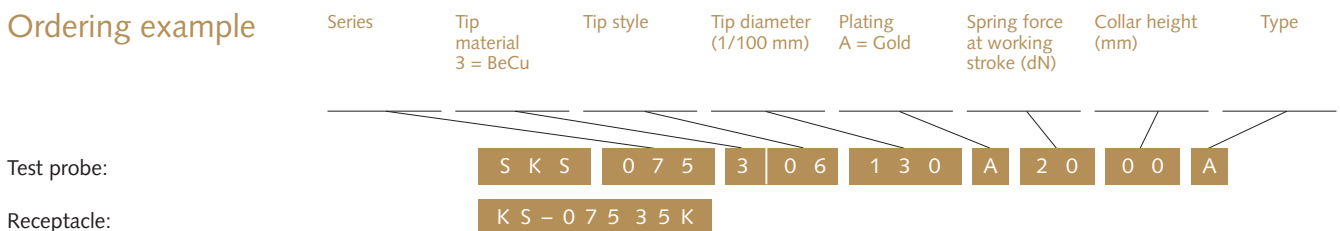

SKS 100

Switching Probe
Closing version (NO)

Grid:

≥ 2,54 mm

≥ 100 Mil

Installation height with KS: 16,4 / 19,1 mm (.646/.752) / variable
Switch path: 4,0 mm (.157)

Mounting and functional dimensions

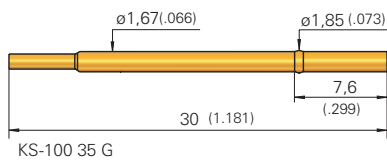
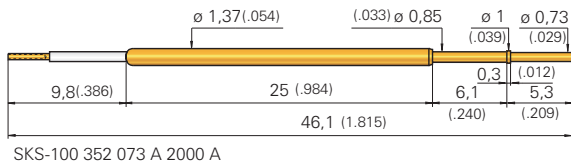
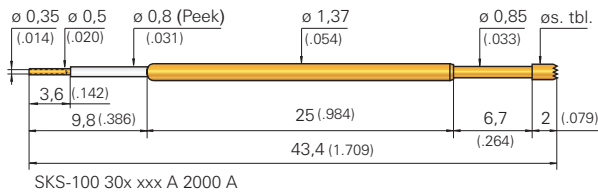

Available tip styles

Material	Tip style	Plating	Further versions	
			∅	∅ (inch)
0 02		A		
3 02		A		
3 06		A		
3 52		A		

Collar height and installation height

To adjust the installation height receptacles with a press ring are used. The receptacles can be inserted up to the press ring or with the press ring pressed into the mounting hole.

Tip style	Installation height with KS (inch)	Maximum stroke (inch)
02	16,4 mm (.646) / var.	6,3 mm (.248)
06	19,1 mm (.752) / var.	6,0 mm (.236)

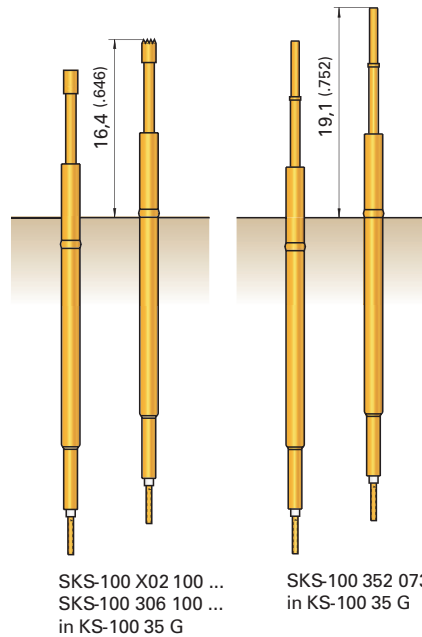

Mechanical data

Switch path: 4,0 mm (.157) ± 0,2 (.008)

Recomm. working stroke: 5,0 mm (.197)

Maximum stroke: 6,0 mm (.236)
resp. 6,3 mm (.248)

Spring force at switch. point: 1,0 N (3.6oz)

Spring force at work. stroke: 2,0 N (7.2oz)

Electrical data

Current rating: 3 A
(see page 100)

Operating temperature

Standard: -40° up to +80° C

Materials

Plunger: BeCu, gold-plated

Barrel: Bronze, gold-plated

Spring: Steel, gold-plated

Receptacle: Nickel-silver, gold-plated

Contact terminal: Brass, gold-plated

Insulator: Peek

Warning:

Do not solder the cable to the crimp points of the receptacle.

Mounting hole size

When press ring is pressed into the mounting hole
in CEM1 and FR4: ∅ 1,70 - 1,75 mm
(.0669 - .0689)

press ring as a collar-stop

in CEM1: ∅ 1,68 - 1,69 mm (.0661-.0665)

in FR4: ∅ 1,69 - 1,70 mm (.0665-.0669)

Ordering example

Series	Tip material	Tip style	Tip diameter (1/100 mm)	Plating	Spring force at working stroke (dN)	Collar height (mm)	Type
SKS	0 = Delrin 3 = BeCu			A = Gold			
100							
3							
06							
100							
A							
20							
00							
A							
KS - 100 35 G							

Test probe:

Receptacle:

Grid:
≥ 2,54 mm
≥ 100 Mil

Installation height with KS: 10,2 mm (.402)
Switch path: 1,5 mm (.059)

Mounting and functional dimensions

SKS-215

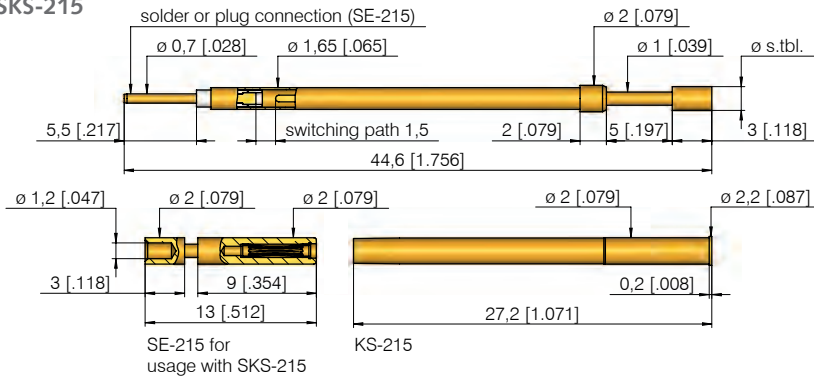

SKS-215 ... E

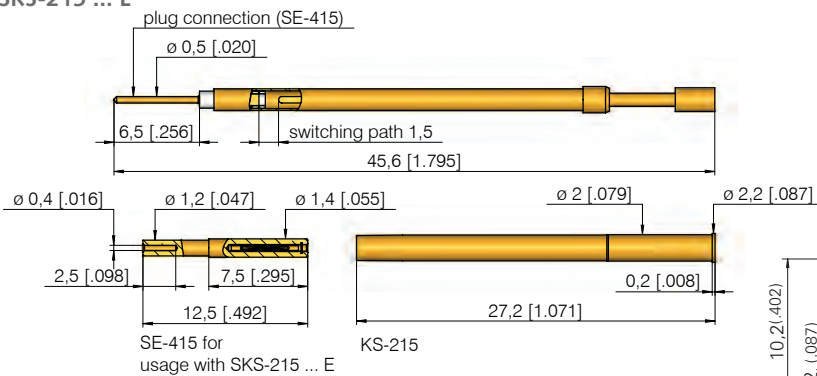

Quick-exchange system with SKS-215 ... E

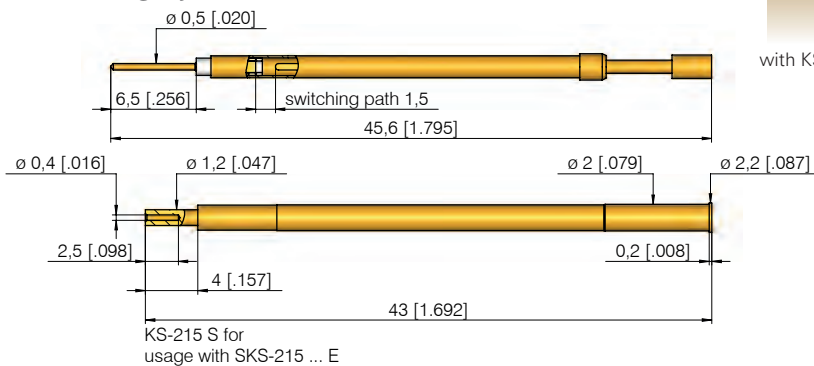

Available tip styles

Material	Tip style	Plating	Further versions	
			∅	∅ (inch)
0 02		A		
3 02		A	1,00	(.039)
3 03		A		
3 05		A	0,80	(.031)
3 05		A		
3 06		N	1,50 2,00 2,30	(.059) (.079) (.091)
3 19		A		

NEW
NEW
NEW

Collar height and installation height

The installation height of the tip (dimension without KS) is determined by the collar height.

Collar height	Installation height without receptacle
02	10,0 mm (.394)

Warning:

Do not solder the cable to the crimp points of the receptacle.

The KS-215 S receptacle enables easy exchange of switching probes without removing the wiring connection. This receptacle can only be used with SKS-215 ... E.

Note:

Screw-in version see SKS-215 M shown on page 109.

Mechanical data

Switch path: 1,5 mm (.059) ± 0,2 (.008)
 Recomm. working stroke: 4,0 mm (.157)
 Maximum stroke: 5,0 mm (.197)
 Spring force: 0,8 / 1,5 / 3,0 N
 Spring force at switch point: 0,23N (0.8oz);
 0,45 N (1.6oz); 0,9 N (3.2oz)
 Spring force at work. stroke: 0,8 N (2.9oz);
 1,5 N (5.4oz); 3,0 N (10.8oz)

Materials

Plunger: BeCu, gold- or nickel-plated
 (or gold-plated with)
 Barrel: Brass, gold-plated
 Spring: Steel, gold-plated
 Receptacle: Brass, gold-plated
 Contact terminal: Brass, gold-plated

Mounting hole size

with receptacle:
 in CEM1: ∅ 1,98 - 2,00 mm
 (.078 - .079)
 in FR4: ∅ 1,99 - 2,01 mm
 (.078 - .079)
 without receptacle: ∅ 1,65 mm (.065)

Electrical data

Current rating: 3 A
 (see page 100)

Operating temperature

Standard: -40° up to +80° C

Ordering example

Series	Tip material	Tip style	Tip diameter (1/100 mm)	Plating	Spring force at working stroke (dN)	Collar height (mm)	Type (alternative E)
	0 = Delrin 3 = BeCu			A = Gold N = Nickel			

Test probe:

S K S 2 1 5 3 0 2 1 8 0 A 3 0 0 2

Receptacle:

K S - 2 1 5 K S - 2 1 5 S

Lamellar plug:

S E - 2 1 5 S E - 4 1 5

All specifications are subject to change without prior notification

SKS 415

Switching Probe
Closing version (NO)

Grid:

≥ 3,50 mm

≥ 140 Mil

Installation height with KS: 10,4 - 24,9 mm (.409 - .980)

Switch path: 1,7 mm (.067)

Mounting and functional dimensions

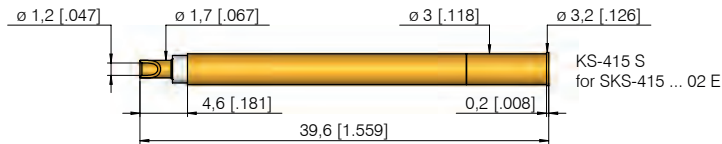
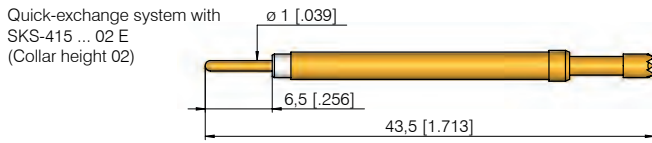
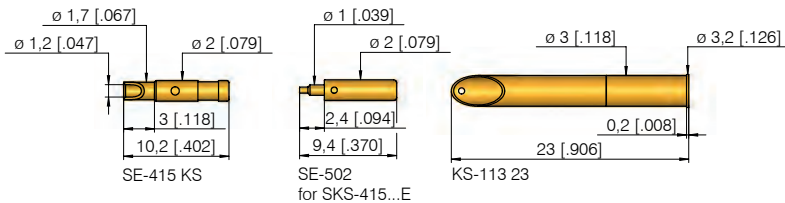
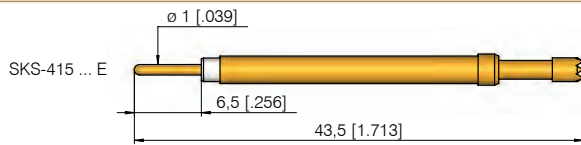
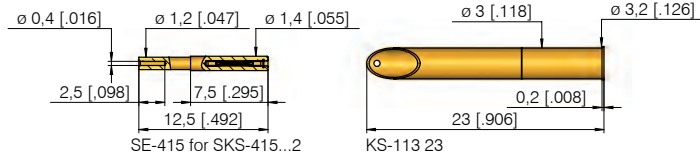
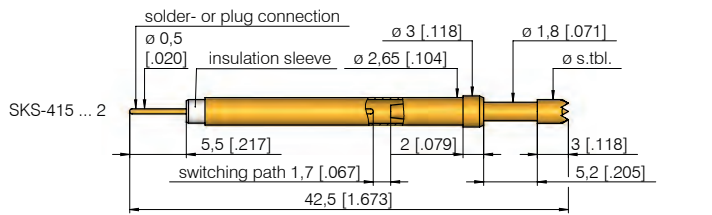

Collar height	Installation height without KS with tip style 02/03/06	Installation height without KS with tip style 53/56
02	10,2 mm (.402)	16,7 mm (.657)
05**	13,2 mm (.520)	19,7 mm (.776)
10**	18,2 mm (.717)	24,7 mm (.972)

** not usable with KS-415 S

Mechanical data

Switch path: 1,7 mm (.067) ± 0,2 (.008)

Recomm. working stroke: 4,2 mm (.165)

Maximum stroke: 5,2 mm (.205)

Spring force at switch point: 0,9 N (3.2oz)

Spring force at working stroke: 2,3 N (8.3oz)

Materials

Plunger: BeCu, gold-plated (or gold-plated with insulator cap)

Barrel: Brass, gold-plated

Spring: Steel, gold-plated

Receptacle: Brass, gold-plated

Electrical data

Current rating: 5 A (see page 100)

Operating temperature

Standard: -40° up to +80° C

Available tip styles

Material	Tip style	Plating	Further versions	
			∅	∅ (inch)
0 02		A	5,00 2,30	(.197) (.091)
3 02		A		
3 02		A		
3 03		A		
3 06		A		
3 06		A		
3 06		A	4,00	(.157)
3 19		A		
3 53*		A		
3 56*		A		
3 56*		A		
3 56*		A		

* Tip length 9,5 mm (.374)
Total length 6,5 mm (.256) longer as standard

Mounting hole size

with receptacle: ∅ 2,98 - 2,99 mm (.1173 - .1177)

without receptacle: ∅ 2,65 mm (.1043)

Collar height and installation height

To adjust the installation height (dimension without KS) test probes with different collar heights are available.

Note:

The receptacle can be used from grid size 4,50 mm (180 Mil) upwards.

Screw-in version:

see SKS-465 MF and SKS-465 SF shown on page 110 and 112. The KS-415 S receptacle enables easy changing of the SKS-415 ... 02 E switching probe without removing the wiring connection.

Ordering example

Series	Tip material	Tip style	Tip diameter (1/100 mm)	Plating	Spring force at working stroke (dN)	Collar height (mm)	Type (alternative E)
0 = Delrin 3 = BeCu				A = Gold			

Test probe:

S K S 4 1 5 3 0 6 2 3 0 A 2 3 0 2 2

Receptacle:

K S - 1 1 3 2 3 K S - 4 1 5 S

Lamellar plugs:

S E - 4 1 5 S E - 5 0 2 S E - 4 1 5 K S

Grid:
 ≥ 3,50 mm
 ≥ 140 Mil

Installation height with KS: 13,2 mm (.520)
Switch path: 2,4 mm (.094)

Mounting and functional dimensions

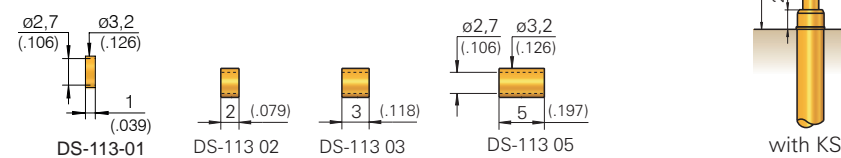
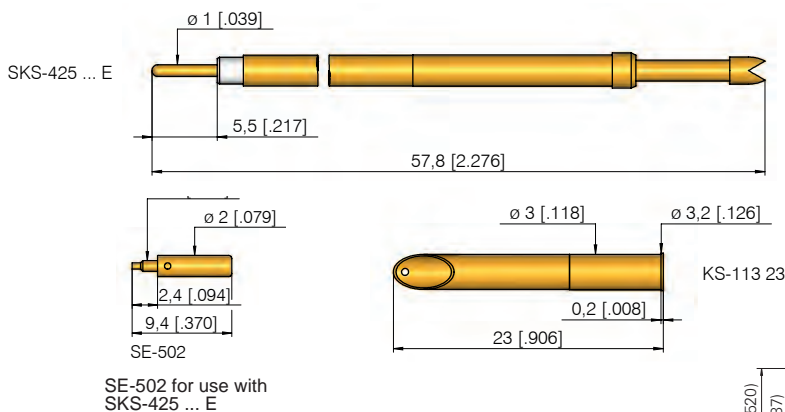
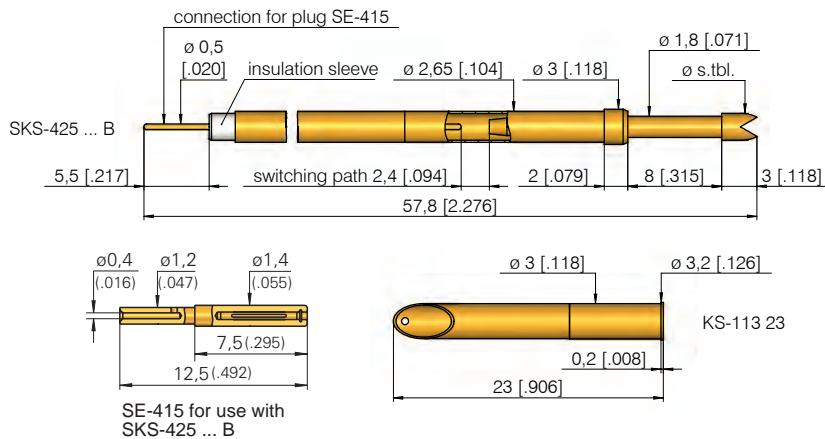

Available tip styles

Material	Tip style	Plating	Further versions	
			Ø	Ø (inch)
0 02		A	5,00	(.197)
3 04		A		
3 06		A	4,00	(.157)

Collar height and installation height

The installation height of the tip (dimension without KS) is determined by the collar height.

Collar height	Installation height without receptacle
02	13,0 mm (.512)

Mechanical data

Switch path: 2,4 mm (.094) ± 0,2 (.008)
Recomm. working stroke: 6,4 mm (.252)
Maximum stroke: 8,0 mm (.315)
Spring force at switch point: 0,9 N (3.2oz)
Spring force at working stroke: 2,5 N (9.0oz)

Materials

Plunger: BeCu, gold-plated (or gold-plated with insulator cap)
Barrel: Brass, gold-plated
Spring: Steel, gold-plated
Receptacle: Brass, gold-plated

Note:

The receptacle can be used from grid size 4,5 mm (180 Mil) upward.

Electrical data

Current rating: 5 A
 (see page 100)

Mounting hole size

with receptacle: Ø 2,98 - 2,99 mm (.1173 - .1177)
without receptacle: Ø 2,65 mm (.1043)

Operating temperature

Standard: -40° up to +80° C

Ordering example

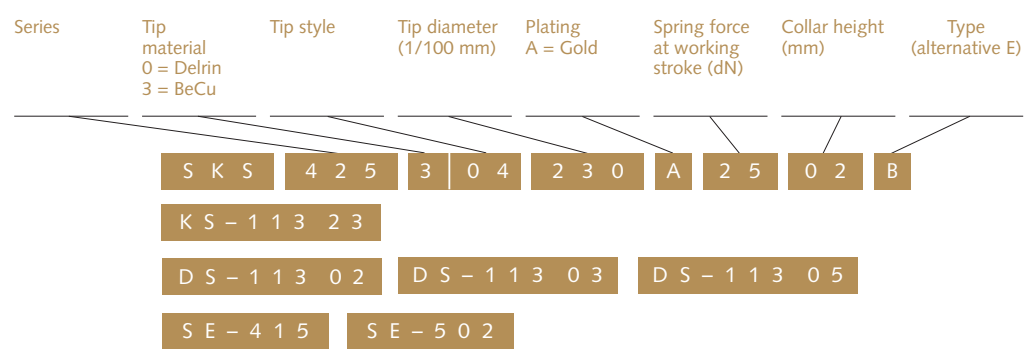

SKS 419 / 429

Switching Probe with Long Stroke - High Stability
Closing version (NO)

Grid:

≥ 7,5/10,0 mm

≥ 300/400 Mil

Installation height with KS: 27,3 / 27,4 mm (1.075 / 1.079)

Switch path: 2,0 mm (.079)

Mounting and functional dimensions

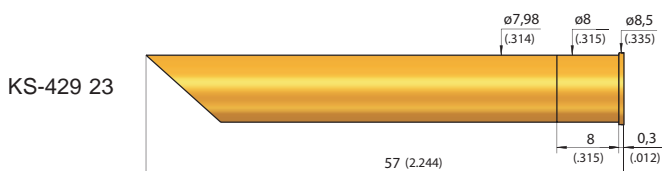
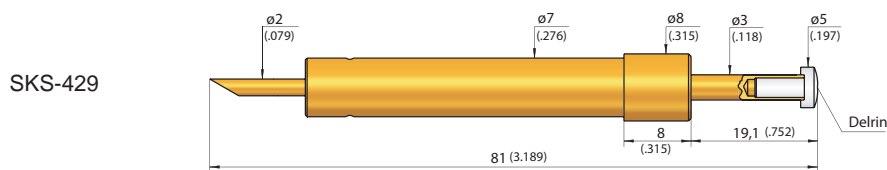
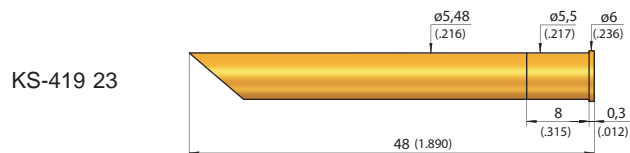
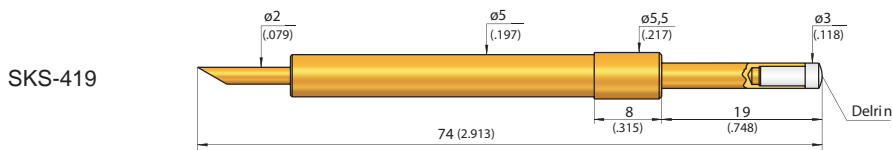

SKS 419	
Mechanical data	
Switch path:	2,0 mm (.079) ± 0,2 (.008)
Maximum stroke:	14,0 mm (.551)
Spring force at switch.point:	2,6 N (9.4oz)
Spring force 80% stroke:	5,2 N (18.8oz)
Spring force max. stroke:	6,5 N (26.0oz)

Electrical data	
Current rating:	5 A
(see page 100)	

Operating temperature	
Standard:	-40° up to +80° C

Mounting hole size	
with receptacle:	∅ 5,49 mm (.216)
without receptacle:	∅ 5,00 mm (.197)

Materials	
Plunger:	BeCu, gold-plated with insulator cap (Delrin)
Barrel:	Brass, gold-plated
Spring:	Steel, gold-plated
Receptacle:	Brass, gold-plated

SKS 429	
Mechanical data	
Switch path:	2,0 mm (.079) ± 0,2 (.008)
Maximum stroke:	16,0 mm (.630)
Spring force at switch.point:	2,9N (10.5oz)
Spring force 80% stroke:	6,4 N (23.2oz)
Spring force max. stroke:	8,0 N (31.0oz)

Electrical data	
Current rating:	5 A
(see page 100)	

Operating temperature	
Standard:	-40° up to +80° C

Mounting hole size	
with receptacle:	∅ 7,99 mm (.315)
without receptacle:	∅ 7,00 mm (.276)

Materials	
Plunger:	BeCu, gold-plated with insulator cap (Delrin)
Barrel:	Brass, gold-plated
Spring:	Steel, gold-plated
Receptacle:	Brass, gold-plated

Ordering example

Series	Tip material 0 = Delrin	Tip style	Tip diameter (1/100 mm)	Plating A = Gold	Spring force at max. stroke (dN)	Collar height (mm)
--------	----------------------------	-----------	----------------------------	---------------------	--	-----------------------

Test probe:	S	K	S	4	1	9	0	0	5	3	0	0	A	6	5	0	8
Test probe:	S	K	S	4	2	9	0	0	5	5	0	0	A	8	0	0	8
Receptacle for SKS-419:	K	S	-	4	1	9	2	3									
Receptacle for SKS-429:	K	S	-	4	2	9	2	3									

SKS 215 M / 215 MF

Screw-in Switching Probe
Closing version (NO)

Grid:
≥ 2,54 mm
≥ 100 Mil

Installation height with KS: 10,2 - 20,0 mm (.402 - .787)
Switch path: 1,5 mm (.059)

SKS-215 ... M

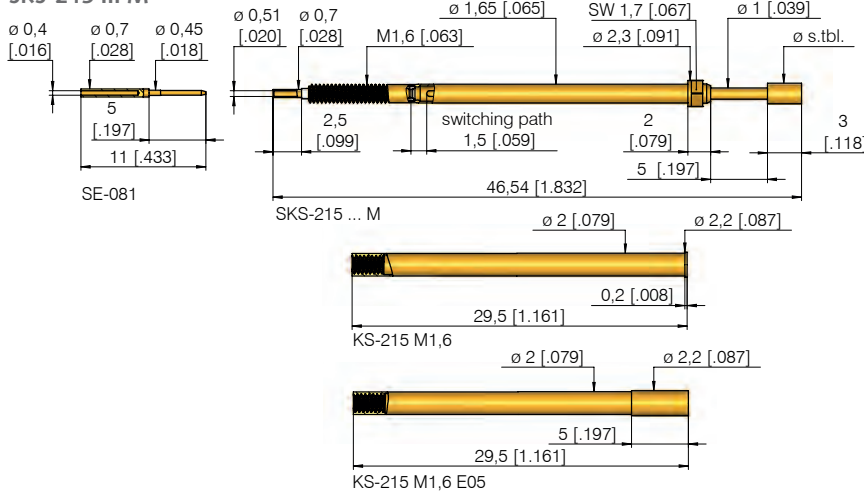

Quick-exchange system

SKS-215 ... MF

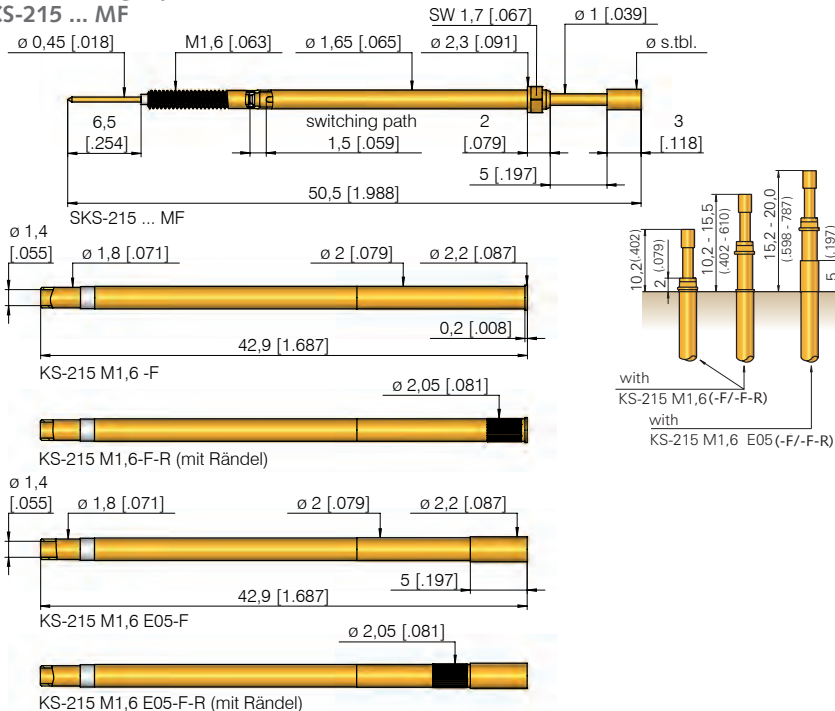

Available tip styles

Material	Tip style	Plating	Further versions	
			Ø	Ø (inch)
0 02		A		
3 02		A	1,00	(.039)
3 03		A		
3 05		A	0,80	(.030)
3 05		A		
3 06		N	1,50 2,00 2,30	(.059) (.079) (.091)
3 19		A		

Collar height and installation height

Crimps in the receptacle prevent the test probe from rotating. Different installation heights can be variably achieved with different receptacles.

Designation	Install. heights
KS-215 M1,6 (-F/-F-R)	10,2 - 15,5 mm (.402 - .610)
KS-215 M1,6 E05 (-F/-F-R)	15,2 - 20,0 mm (.598 - .787)

Note:

SKS-215 ... M is screwed into KS-215 ... M using specialised tools (shown on page 196).
Recommended screw-in torque:
Min.: 3 cNm / Max.: 5 cNm

Quick-exchange receptacles:

Receptacles with end designation "-F" are quick-exchange receptacles. The two wires are soldered to the outside surface of the receptacle and the central terminal point after assembling the receptacle in the mounting hole. The switching probe can now be inserted or changed without any further soldering work.

The quick-exchange system "F" is not compatible with the previous version "S", which is still available upon request.

Mechanical data

Switch path: 1,5 mm (.059)
± 0,2 mm (.008)
Working stroke: 4,0 mm (.160)
Maximum stroke: 5,0 mm (.197)
Force at switching point: 0,23 N (.8 oz);
0,45 N (1.6 oz); 0,9 N (3.2 oz)
Force at working stroke: 0,80 N (2.9 oz);
1,50 N (5.4 oz); 3,0 N (10.7 oz)

Electrical data

Current rating: 3 A
(see page 100)

Operating temperature

Standard: -40° up to +80° C

Materials

Plunger: BeCu, gold- or nickel-plated
(or gold-plated with insulator cap)
Barrel: Brass, gold-plated
Spring: Steel, gold-plated
Receptacle: Brass, gold-plated

Mounting hole size

KS without knurl
in CEM1: Ø 1,97 - 1,99 mm (.0776 - .0783)
in FR4: Ø 1,98 - 2,00 mm (.0780 - .0787)
KS with knurl
in CEM1 and FR4: Ø 2,00 - 2,02 mm (.0787 - .0795)

Ordering example

Series	Tip material	Tip style	Tip diameter (1/100 mm)	Plating	Spring force at working stroke (dN)	Collar height (mm)	Type (alternative "MF")
	0 = Delrin 3 = BeCu			A = Gold N = Nickel			

Test probe:

SKS 215 3 02 180 A 30 02 M

Receptacles:

KS-215 M1,6 (-F/-F-R) KS-215 M1,6 E05 (-F/-F-R)

Plug:

SE-081

All specifications are subject to change without prior notification

SKS 465 MF

Screw-in Switching Probe
Closing version (NO)

Grid:

≥ 3,50 mm

≥ 140 Mil

Installation height with KS: 10,4 - 26,7 mm (.409 - 1.051)

Switch path: 1,7 mm (.067)

Mounting and functional dimensions

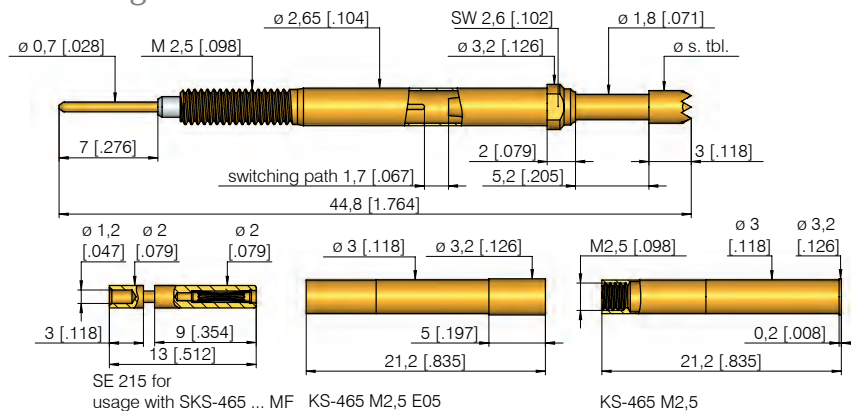

Quick-exchange system

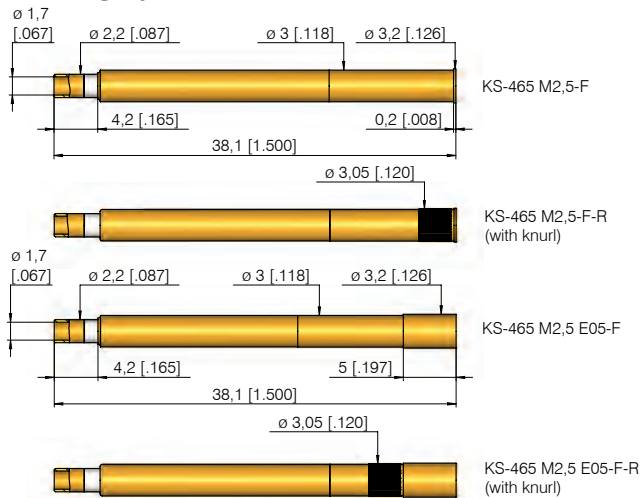

Collar height and installation height

Crimps in the receptacle prevent the test probe from rotating. Different installation heights can be variably achieved with different receptacles.

Receptacle designation	Install. heights with tips 02/03/06/19	Install. height with tips 53/56
KS-465 M2,5 (-F/-F-R)	10,4 - 15,4 mm (.413 - .610)	16,9 - 21,9 mm (.669 - .866)
KS-465 M2,5 E05 (-F/-F-R)	15,2 - 20,2 mm (.598 - .787)	21,7 - 26,7 mm (.854 - 1.043)

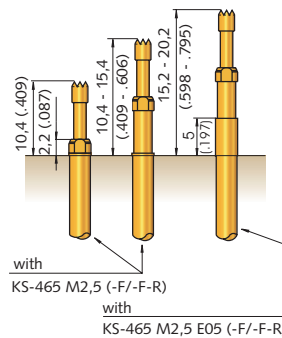

Mechanical data

Switch path: 1,7 mm (.067) ± 0,3 mm (.012)
Recomm. work. stroke: 4,2 mm (.165)
Maximum stroke: 5,2 mm (.205)
Force at
 1,8 N (6.5oz); 4,5 N (15oz)
Force at work. stroke: 2,0 N (7.2oz); 3,5 N (12.7oz); 9,0 N (32.5oz)

Electrical data

Current rating: 3 A (see page 100)
Operating temperature Standard: -40° up to +80° C

Materials

Plunger: BeCu, gold-plated with or without insulator cap
Barrel: Brass, gold-plated
Spring: Stainless steel
Receptacle: Brass, gold-plated
Insulation: Teflon

Mounting hole size

KS without knurl in CEM1 and FR4: Ø 2,98 - 2,99 mm (.117 - .118)
KS without knurl in CEM1 and FR4: Ø 3,00 - 3,02 mm (.118 - .119)

Available tip styles

Material	Tip style	Plating	Further versions	
			Ø	Ø (inch)
0 02		A	5,00 2,30	(.197) (.091)
3 02		A		
3 02		A		
3 03		A		
3 06		A		
3 06		A		
3 06		A	4,00	(.157)
3 19		A		
3 53*		A		
3 56*		A		
3 56*		A		
3 56*		A		

* tip length 9,5 mm (.374)
total length 6,5 mm (.256) longer than standard

Quick-exchange receptacles:

Receptacles with end designation "-F" are quick-exchange receptacles. The two wires are soldered to the outside surface of the receptacle and the central terminal point after assembling the receptacle in the mounting hole. The switching probe can now be inserted or changed without any further soldering work.

The quick-exchange system "F" is not compatible with the previous version "S", which is still available upon request.

Note:

Probes with tip diameter ≤ 3,0 are screwed into KS-465...M using tools, see page 198. SKS-465...MF test probes with tip diameter > 3,0 mm are screwed in using specialised tools (upon request). Recommended screw-in torque: Min.: 3 cNm / Max.: 5 cNm

Ordering example

Test probe:

Receptacles:

Lamellar plug:

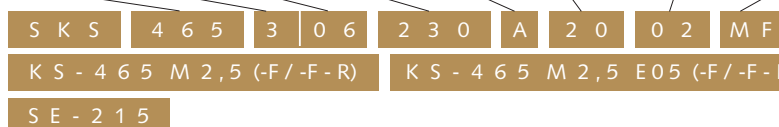

NEW

SKS 463 MF

Screw-in Switching Probe
Opening version (NC)

Grid:
≥ 3,50 mm
≥ 140 Mil

Installation height with KS: 10,4 - 26,7 mm (.409 - 1.051)
Switch path: 1,7 mm (.067)

Mounting and functional dimensions

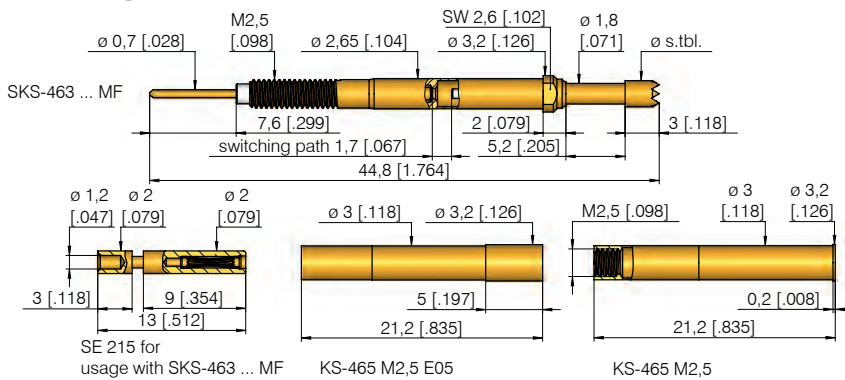

Quick-exchange system

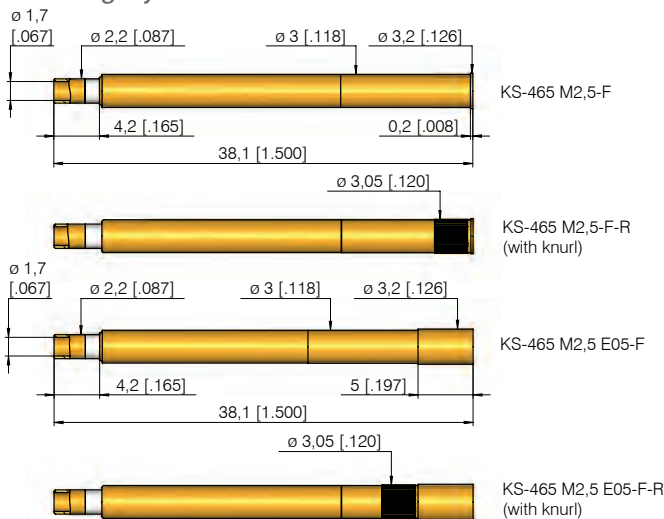

Collar height and Installation height

Crimps in the receptacle prevent the test probe from rotating. Different installation heights can be variably achieved with different receptacles.

Receptacle designation	Install. heights with tips 02/03/06	Install. height with tip 56
KS-465 M2,5 (-F/-F-R)	10,4 - 15,4 mm (.409 - .606)	16,9 - 21,9 mm (.665 - .862)
KS-465 M2,5 E05 (-F/-F-R)	15,2 - 20,2 mm (.598 - .795)	21,7 - 26,7 mm (.854 - 1.051)

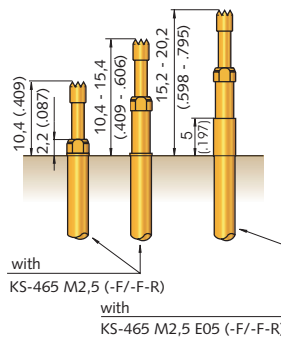

Mechanical data

Switch path: 1,7 mm (.067) ± 0,2 mm (.008)
Recomm. work. stroke: 4,0 mm (.157)
Maximum stroke: 5,0 mm (.197)
Force at switching point: 0,65 N (2.34oz); (.026)
Force at work. stroke: 2,2 N (7.91oz); (.087)

Materials

Plunger: BeCu, gold-plated with or without insulator cap
Barrel: Brass, gold-plated
Spring: Stainless steel
Receptacle: Brass, gold-plated
Insulation: Teflon

Electrical data

Current rating: 3 A (see page 100)

Operating temperature

Standard: -40° up to +80° C

Mounting hole size

KS without knurl in CEM1 and FR4: ϕ 2,98 - 2,99 mm (.117 - .118)
KS with knurl in CEM1 and FR4: ϕ 3,00 - 3,02 mm (.118 - .119)

Available tip styles

Material	Tip style	Plating	Further versions	
			ϕ	ϕ (inch)
0 02		A	3,00	(.118)
3 02		A	3,00	(.118)
3 03		A		
3 06		A		
3 56*		A		

* tip length 9,5 mm (.374)
total length 6,5 mm (.256) longer than standard

Quick-exchange receptacles:

Receptacles with end designation "-F" are quick-exchange receptacles. The two wires are soldered to the outside surface of the receptacle and the central terminal point after assembling the receptacle in the mounting hole. The switching probe can now be inserted or changed without any further soldering work.

The quick-exchange system "F" is not compatible with the previous version "S", which is still available upon request.

Recommended screw-in torque:
Min.: 3 cNm / Max.: 5 cNm

Ordering example

Test probe:

S K S 4 6 3 3 0 6 2 3 0 A 2 2 0 2 M F

Receptacles:

K S - 4 6 5 M 2,5 (-F/-F-R) K S - 4 6 5 M 2,5 E05 (-F/-F-R)

Lamellar plug:

S E - 2 1 5

All specifications are subject to change without prior notification

SKS 465 SF

Screw-in Switching Probe
Closing version (NO)

Grid:

≥ 3,50 mm
≥ 140 Mil

Installation height with KS: 10,4 - 26,7 mm (.409 - 1.051)
Switch path: 1,7 mm (.067)

Mounting and functional dimensions

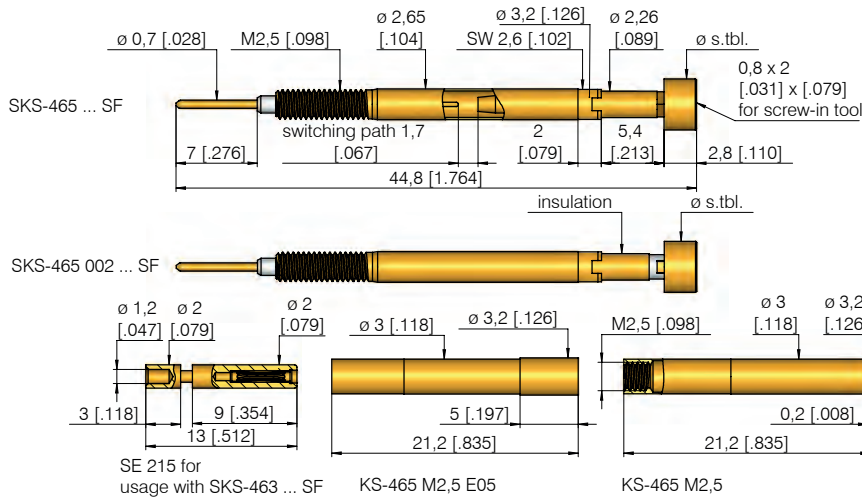

Available tip styles

Material	Tip style for SKS-465 302 / 352 ... S	Plating	Further versions	
			∅	∅ (inch)
3 02		A	3,50	(.138)
			4,00	(.157)
3 02		A	5,00	(.197)
			5,50	(.217)
3 52*		A	3,50	(.138)

* 6,5 mm (.256) longer

Available tip styles

Material	Tip style for SKS-465 002 ... S with insulated tip	Plating	Further versions	
			∅	∅ (inch)
0 02		A	3,50	(.138)
			4,00	(.157)
0 02		A	5,00	(.197)
			5,90	(.232)

Quick-exchange system

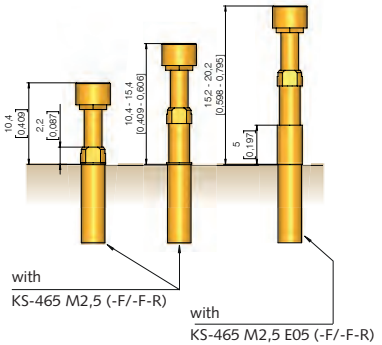
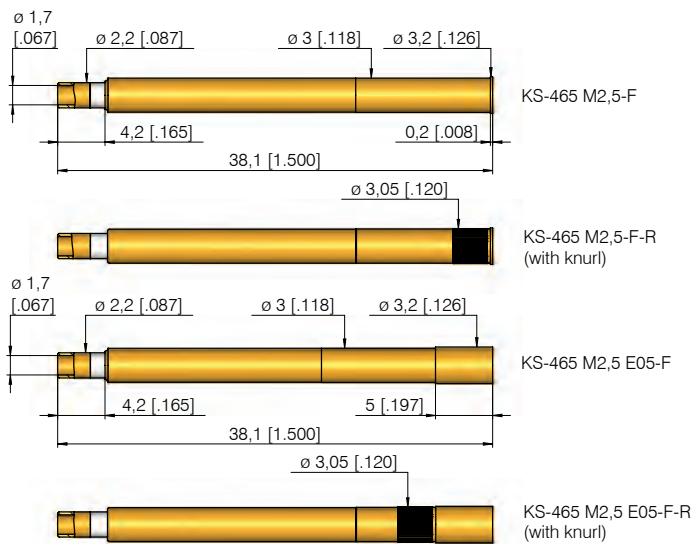

Collar height and installation height

Crimps in the receptacle prevent the test probe from rotating. Different installation heights can be variably achieved with different receptacles.

Receptacle designation	Installation heights with tip style 02	Installation height with tip style 52
KS-465 M2,5 (-F/-F-R)	10,4 - 15,4 mm (.409-.606)	16,9 - 21,9 mm (.665-.862)
KS-465 M2,5 E05 (-F/-F-R)	15,2 - 20,2 mm (.598-.795)	21,7 - 26,7 mm (.854-1.051)

Mechanical data

Switch path: 1,7 mm (.067) ± 0,3 mm (.012)
 Recomm. work. stroke: 4,2 mm (.165)
 Maximum stroke: 4,5 mm (.177)
 Force at switching point: 0,7 N (2.5oz);
 1,8 N (6.5oz); 4,5 N (15oz)
 Force at work. stroke: 2,0 N (7.2oz);
 3,5 N (12.7oz); 9,0 N (32.5oz)

Materials

Plunger: BeCu or brass, gold-plated
 Barrel: Brass, gold-plated
 Spring: Steel, gold-plated or stainless steel
 Receptacle: Brass, gold-plated
 Insulation: Teflon (on tip 002: PEEK)

Electrical data

Current rating: 3 A
 (see page 100)
 Operating temperature
 Standard: -40° up to +80° C

Mounting hole size

KS without knurl ∅ 2,98 - 2,99 mm (.117 - .118)
 in CEM1 and FR4:
 KS without knurl ∅ 3,00 - 3,02 mm (.118 - .119)
 in CEM1 and FR4:

Quick-exchange receptacles:

Receptacles with end designation "-F" are quick-exchange receptacles. The two wires are soldered to the outside surface of the receptacle and the central terminal point after assembling the receptacle in the mounting hole. The switching probe can now be inserted or changed without any further soldering work.

The quick-exchange system "F" is not compatible with the previous version "S", which is still available upon request.

Recommended screw-in torque:
 Min.: 3 cNm / Max.: 5 cNm

Ordering example

Series	Tip material	Tip style	Tip diameter (1/100 mm)	Plating	Spring force at working stroke (dN)	Collar height (mm)	Type
SKS	0 = Peek 3 = BeCu			A = Gold			

Test probe:

SKS 465 3 02 4 50 A 2 0 0 2 SF

Receptacles:

KS-465 M2,5 (-F/-F-R) KS-465 M2,5 E05 (-F/-F-R)

Lamellar plug:

SE-215

Grid:
≥ 4,00 mm
≥ 157 Mil

Installation height with KS: 9,2 mm (.362)
Switch path: 1,7 mm (.067)

Mounting and functional dimensions

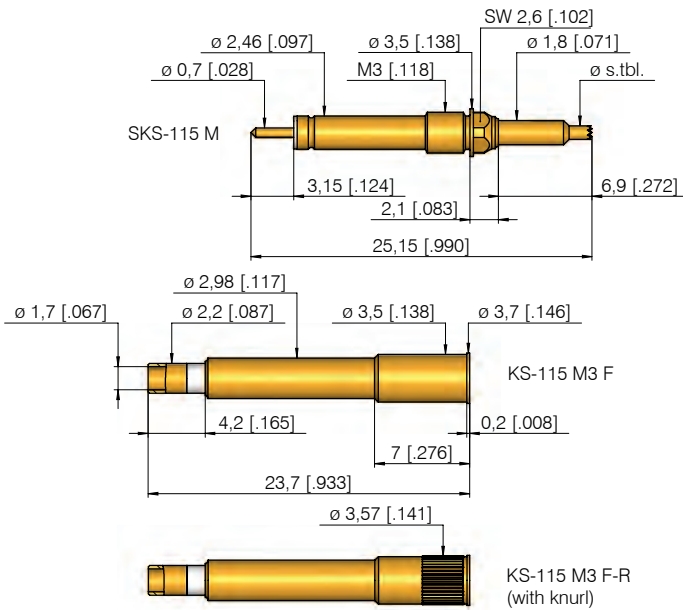

Available tip styles

Material	Tip-style	Standard Plating	further versions	
			ϕ	ϕ (inch)
0 02		A	3,0	A
3 02		A		
3 02		A	3,0	A
3 06		A		
3 06		A	3,0	A

Mechanical data

Switch path: 1,7 mm (.067) ± 0,2 (.008)
 Recomm. work. stroke: 4,0 mm (.157)
 Maximum stroke: 5,0 mm (.197)
 Spring force at switch point: 0,5 N (1.8oz)
 0,7 N (2.5oz); 1,0 N (3.6oz)
 Spring force at work stroke: 1,5 N (5.4oz)
 2,0 N (7.2oz); 3,0 N (10.79oz)

Electrical data

Current rating: 3 A
 (see page 100)

Operating temperature

Standard: -40° up to +80° C

Materials

Plunger: BeCu, gold-plated
 (or gold-plated with insulator cap)
 Barrel: Brass, gold-plated
 Spring: Steel, gold-plated
 Receptacle: Brass, gold-plated

Mounting hole size

KS without knurl: ϕ 3,48 - 3,49 mm (.137 - .137)
 KS without knurl in CEM1 and FR4: ϕ 3,50 - 3,52 mm (.138 - .139)

Quick-exchange receptacles:

The two wires are soldered to the outside surface of the receptacle and the central terminal point after assembling the receptacle in the mounting hole. The switching probe can now be inserted or changed without any further soldering work.

Recommended screw-in torque:
 Min.: 3 cNm / Max.: 5 cNm

Ordering example

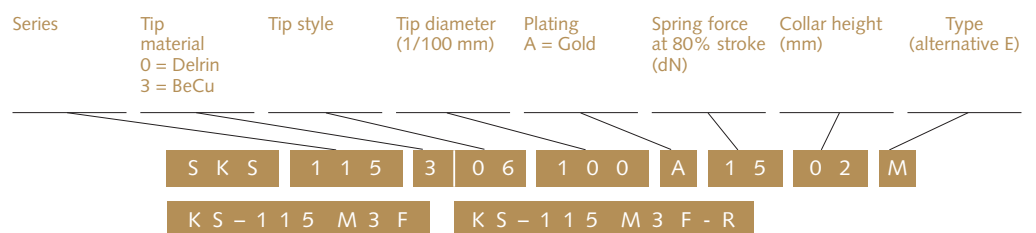

SKS 435 M

Screw-in Switching Probe
Closing version (NO)

Grid:

≥ 4,50 mm

≥ 177 Mil

Installation height: 20,8 mm (.819)

Switch path: 6,0 mm (.236)

Mounting and functional dimensions

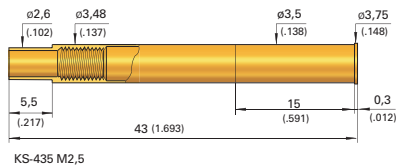
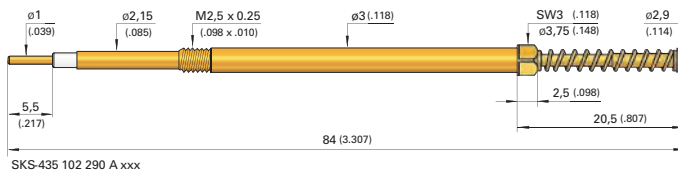

Available tip styles

Material	Tip style	Plating	Further versions	
			∅	∅ (inch)
1 02		∅ 2,90 (.114)	A	

Collar height and installation height

The installation height of the tip is always 20,8 mm (.819) (dimensions with receptacle). Test probe can only be used with receptacle.

Mechanical data

Switch path: 6,0 mm (.236)
± 0,2 mm (.008)
Recomm. working stroke: 7,0 mm (.275)
Maximum stroke: 8,0 mm (.315)
Force at switching point: 13,5 N (48.6oz);
18,5 N (66.6oz); 23,5 N (84.6oz)
Force at working stroke: 13,5 N (48.6oz);
18,5 N (66.6oz); 23,5 N (84.6oz)

Electrical data

Current rating: 3 A
(see page 100)

Operating temperature

Standard: -40° up to +80° C

Materials

Plunger: Brass, gold-plated
Barrel: Brass, gold-plated
Spring: Steel, gold-plated or stainless steel
Receptacle: Brass, gold-plated
Insulation: Teflon

Recommended screw-in torque:
Min.: 10 cNm / Max.: 20 cNm

Mounting hole size

in CEM1 and FR4: ∅ 3,48 - 3,49 mm
(.1370 - .1374)

Ordering example

Series	Tip material 1 = Brass	Tip style	Tip diameter (1/100 mm)	Plating A = Gold	Spring force (dN)	Type
--------	---------------------------	-----------	----------------------------	---------------------	----------------------	------

Test probe:

S K S 4 3 5 1 0 2 2 9 0 A 1 3 5 M

Receptacle:

K S - 4 3 5 M 2 . 5

Sealed with **EXCELLENCE.**

INGUN offers an unbeatable range of over **20,000 versions** and **400 series** **standard** and **customised test probes**:

- Bead probes
- Rotating probes
- E-type
- Fine pitch
- Flying probes
- Int. standard test probes
- Metric test probes



ICT/FCT
Test Probes

www.ingun.com

Screw-in Test Probes Cable Harnesses and Plug Connection

Screw-in test probes are often used to contact cable harnesses and plug connectors. They remain securely positioned in the receptacle even under challenging test conditions with vibrations or axial force. Screw-in test probes with thread have the designation 'M' at the end of the part number.

Cable harnesses are the central connection elements between various components in the automobile industry and mechanical engineering and supply these with either power or signals. To guarantee uninterrupted operation, high demands are placed on the cable harness as well as the plug connector used.

The cable harness has to pass various tests before it is fitted, these include: connection test, position test, push-back test, and function test.

A further area of application for screw-in probes is the contacting of plug connectors on various electronic devices, such as car radios, control units, PCs, smart devices, and many more.

Assorted applications of screw-in test probes

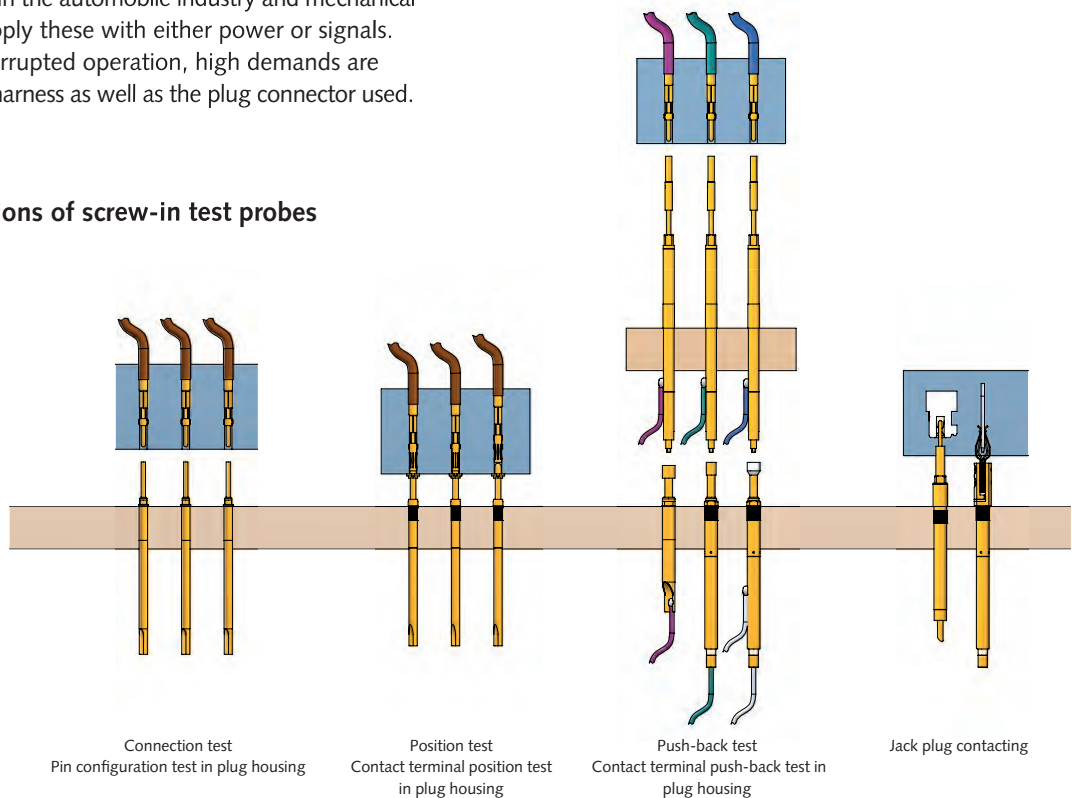

Grid size / series	Screw-in probes	Step probes	Push-back probes in combination with test probe (GKS) or switching probe (SKS)	Non-rotating test probes
≥ 1.27 mm (≥ 50 Mil)	GKS-087 M GKS-050 M	-	-	-
≥ 1.91 mm (≥ 75 Mil)	GKS-075 M	-	-	-
≥ 2.54 mm (≥ 100 Mil)	GKS-112 M / GKS-204 M GKS-427 M / GKS-899 M GKS-212 M	T-899 M T-112 M / T-912 M	VF 25 VF 3	GKS-710 GKS-746 M
≥ 4.00 mm (≥ 160 Mil)	GKS-113 M GKS-913 M	T-113 M / T-888 M	-	NEW (KK-541 / VK-541)
≥ 4.5 mm (≥ 177 Mil)	GKS-500 M GKS-313 M	NEW T-785 M	-	GKS-803 M GKS-747 M
≥ 5.08 mm (≥ 200 Mil)	GKS-854 M	-	VF 4 VF 5	GKS-714 GKS-098 / GKS-098 M NEW (HKF-617)
Page(s)	120 - 134	135 - 140	142 - 145	146 - 151 (93-95)

Many press-in test probes offered by INGUN are also available as a **screw-in version**. Thus, a secure hold during testing is guaranteed. Screw-in probes are especially recommended for applications with possible vibrations or unwanted side forces and axial forces.

Step probes are inserted in the plug housings to test the correct position of the contact terminals (contact sheets). Contact will only occur when the pin of the step probe is correctly positioned. INGUN offers a wide variety of step probes with tip dimensions, stop collar (disk) dimensions, and pin length.

When finally plugging the plug connectors together, it is important that the contact terminals (contact sheets) remain in the correct position, and cannot be pushed back. For this test, **push-back probes** with a spring force of up to 34 N are used.

For testing flat connector blades or jacks which can only be contacted in one position, **non-rotating probes** are used. These probes are already aligned in the correct position during assembly.

Screw-in Test Probes

Screw-in test probes	120 - 134
Step probes	135 - 140
Push-back probes	142 - 145
Non-rotating test probes	146 - 151 (93 - 95)

Note:

See High Current Probes chapter for all screw-in HSS (series ending with "M").

See Switching Probes chapter for all screw-in SKS (series ending with "M").

Note:

See next page for overview and comparison table.

Screw-in Test Probes

Overview and Comparison

Test probe version	Series	Grid size (≥ mm)	Working stroke (mm)	Max. stroke (mm)	Current rating (A)	Spring forces (N)		Installation height with receptacle (mm)		Shortest probe (mm)	Page
						min.	max.	min.	max.		
Screw-in test probes	GKS-087 M	1.27	4	5	2 – 3	0.5	0.8	7.2	8.2	28	120
	GKS-050 M	1.27	4.3	6.35	2 – 3	1	2	10.5	12.5	47.3	121
	GKS-075 M	1.91	4.3	6.35	3 – 4	0.6	2.8	10.5	-	35.9	122
	GKS-427 M	2.54	3.5	4.5	5 – 8	0.8	2.5	8.7	-	19.5	123
	GKS-899 M	2.54	3.5	4.4	3 – 5	0.7	3	12.8	-	27.9	124
	GKS-112 M	2.54	4	5.3 / 8	5 – 8	0.6	5	10.5	19	35.8	125
	GKS-204 M	2.54	8	10	5 – 8	0.8	3	16	23	47.9	126
	GKS-913 M	4	2.8	3.5	5 – 8	0.8	2.5	7.3	8.9	17.1	127
	GKS-113 M	4	4	5.3	5 – 8	0.3	5	10.5	-	28.3	128
	GKS-103 M	4	4.8	6	5 – 8	0.8	5	12.55	-	32	129
	GKS-503 M	4	5.6	7	5 – 15	1.5	5	13.25	-	38	130
	GKS-500 M	4.5	5.6	7	5 – 15	1.5	5	13.25	-	38	131
	GKS-854 M	5.08	4.4	5.5	10 – 12	3	5	10.8	-	43.1	132
	GKS-212 M	2.54	12	14.5	2 – 3	3	-	25.2	-	67.5	133
GKS-313 M	4.5	12	14.3	3 – 5	1.5	3	19.5	25	57.3	134	
Step probes	T-899 M	2.54	3.5	4.4	3 – 5	0.7	3	12	14.8	27.1	135
	T-112 M	2.54	4	5	5 – 8	0.6	5	9.2	12.7	34.5	136
	T-912 M	2.54	4	5	5 – 8	1.5	5	8.9	13.7	34.2	137
	T-113 M	4	4	5	5 – 8	0.3	5	9.5	14.3	27.3	138
	T-888 M	4	4	5	5 – 8	1.5	3	9.5	14.3	27.3	139
Push-back probes	NEW T-785 M	4.5	4	5.3	16	10		14.3	15.3	52.1	140
	VF 25	2.54	5	6	5	10	15	40.5	-	69.5	142
	VF 3	3	5	5.5	8	5	15	40.5	46.5	69.7	143
	VF 4	5	5.5	7	8	15	25	40.5	46.5	69.5	144
Non-rotating test probes	VF 5	5	9.5	12	10	15	34	36.7	-	96	145
	GKS-710	2.54	4	5	5 – 8	1.5	5	13.2	18.2	35.1	146
	GKS-746 M	2.54	4	4.4	5 – 8	1.5	3	10.5	-	40.2	147
	GKS-747 M	4.5	4	5	8	1.5	3	16.2	20.2	36	148
	GKS-803 M	4.5	6.4	8	5 – 15	1.5	5	18.3	-	48	149
	GKS-714	5.08	4/6	5/7	8 – 10	1.5	5	15	22.2	29.8	150
	GKS-098	5.08	4	5	8 – 10	1.5	5	15.75	-	28.5	150
	GKS-098 M	5.08	4	5	8 – 10	1.5	3	15.3	-	40	151
	NEW VK-541	3.5	3.5	6.5	10	-	-	19.1	-	53.4	93
NEW HKF-617	5.5	4.4	5.5	20/40	10		27.9		57.9	94	
NEW KK-541	3.5	3.5	6.5	20	-	-	16.35	16.55	34.35	95	

Screw-in Test Probes Step Probes

Many press-in test probes offered by INGUN are also available as a **screw-in** version. Thus, a secure hold during testing is guaranteed.

Screw-in probes are especially recommended for applications with possible vibrations or unwanted side forces and axial forces (loosening of probe is avoided).

The test probes are screwed into the receptacle using the appropriate tools. The required screw-in torque is achieved by the spanner flat on the barrel.

The electrical connection is made via the receptacle using a solder cup or wire-wrap. Receptacles also sometimes feature an axial bore hole for leakage tests, or are designed to be vacuum sealed.

Step probes are inserted in the plug housings to test the correct position of the contact terminals (contact sheets). Contact will only occur when the pin of the step probe is correctly positioned. INGUN offers a wide variety of step probes with tip dimensions, stop collar (disk) dimensions and pin length.

The step probes are screwed into the receptacle using the spanner flat on the barrel, or a positive-locking connection on the tip of the plunger.

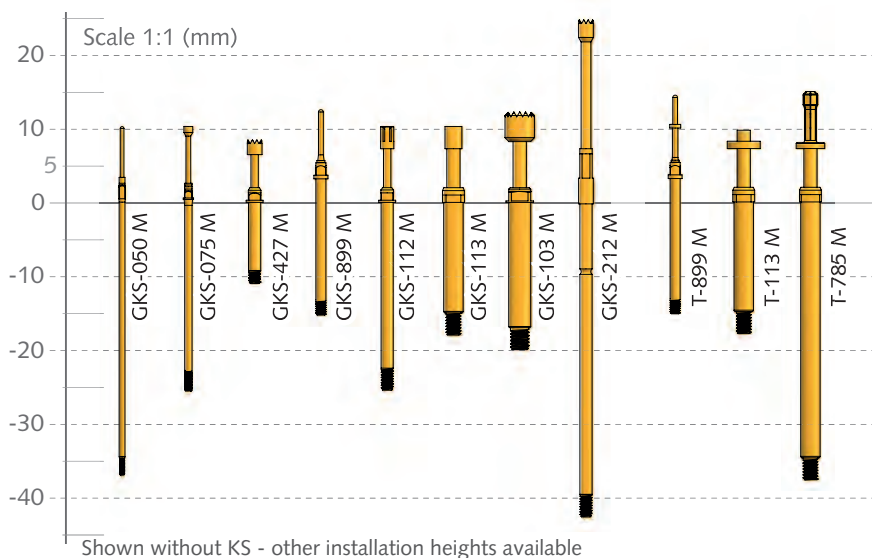

Screw-in Test Probes

GKS-087 M	120
GKS-050 M	121
GKS-075 M	122
GKS-427 M	123
GKS-899 M	124
GKS-112 M	125
GKS-204 M	126
GKS-913 M	127
GKS-113 M	128
GKS-103 M	129
GKS-503 M	130
GKS-500 M	131
GKS-854 M	132
GKS-212 M	133
GKS-313 M	134

Step Probes

T-899 M	135
T-112 M	136
T-912 M	137
T-113 M	138
T-888 M	139
T-785 M NEW	140

Note:
See page 118 for overview and comparison table.

GKS 087 M

Screw-in Test Probe

Grid:

≥ 1,27 mm

≥ 50 Mil

Installation height with KS: 7,2 / 8,2 mm (.283 / .323)

Recommended stroke: 4,0 mm (.157)

Mounting and functional dimensions

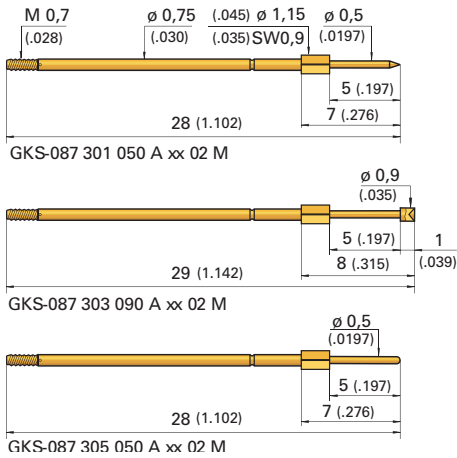

Available tip styles

Material	Tip style	Plating	Further versions	
			∅	∅ (inch)
3 01		A	∅ 0,50 (.020)	
3 03		A	∅ 0,90 (.035)	
3 05		A	∅ 0,50 (.020)	

Receptacles

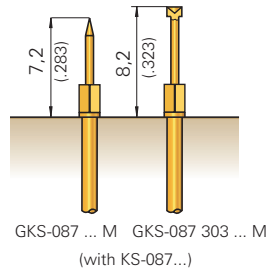
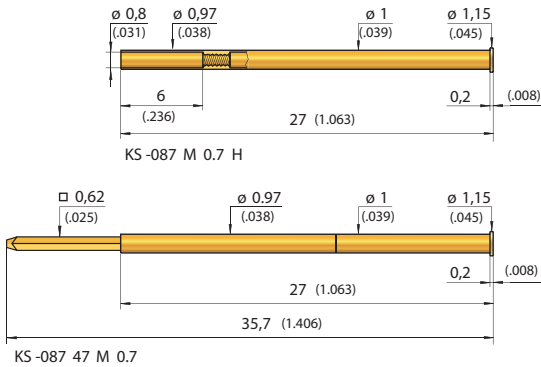

Collar height and installation height

The installation height of the tip (dimension with receptacle) is determined by the collar height and the tip style. The collar height of the GKS-087 series is always 02.

Collar height	Tip style	Diameter	Installation height
02 M	01	0,50 (.020)	7,2 mm (.283)
02 M	03	0,90 (.035)	8,2 mm (.323)
02 M	05	0,50 (.020)	7,2 mm (.283)

Mechanical data

Working stroke: 4,0 mm (.157)
Maximum stroke: 5,0 mm (.197)
Spring force at work. stroke: 0,5 N (1.8oz)
Alternative: 0,8 N (2.9oz)

Materials

Plunger: BeCu, gold-plated
Barrel: Brass, gold-plated
Spring: Steel, gold-plated
Receptacle: Brass, gold-plated

Recommended screw-in torque:
 Min.: 0,5 cNm / Max.: 1 cNm

Electrical data

Current rating: 2 - 3 A
R_i typical: < 20 mΩ

Mounting hole size

in CEM1: ∅1,00 - 1,02 mm (.0394-.0401)
in FR4: ∅1,01 - 1,03 mm (.0398-.0405)

Operating temperature

Standard: -40° up to +80° C

Ordering example

Series	Tip material	Tip style	Tip diameter (1/100 mm)	Plating	Spring force (dN)	Collar height (mm)	Special designation
3	BeCu			A = Gold			

Test probe:

G K S 0 8 7 3 0 5 0 5 0 A 0 5 0 2 M

Receptacles:

K S - 0 8 7 M 0,7 H K S - 0 8 7 4 7 M 0,7

Grid:
 ≥ 1,27 mm
 ≥ 50 Mil

Installation height with KS: 10,5 / 12,5 mm (.413 - .492)
Recommended stroke: 4,3 mm (.169)

Mounting and functional dimensions

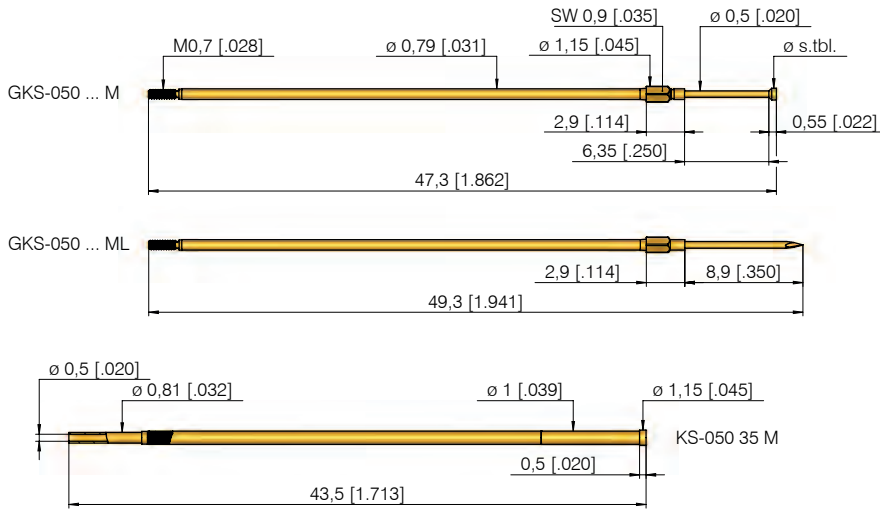

Collar height and installation height

The installation height of the tip (measured with the receptacle) is determined by the collar height of the receptacle.

Collar height	Installation height
03 M	10,5 mm (.413)
03 ML	12,5 mm (.492)

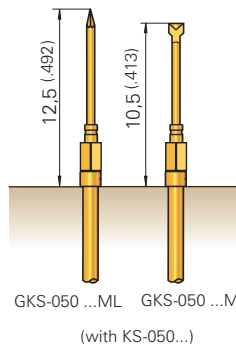

Mechanical data

Working stroke: 4,3 mm (.169)
Maximum stroke: 6,35 mm (.250)
Spring force at work. stroke: 1,5 N (5.4oz)
Alternative: 1,0 N (3.6oz); 2,0 N (7.2oz)

Electrical data

Current rating: 2 - 3 A
R_i typical: < 20 mΩ (** < 100 mΩ)

Operating temperature

Standard: -40° up to +80° C
****with spec. designation "MC", "MLC":** -100° up to +200° C (2,0 N)

Materials

Plunger: BeCu or steel, gold-plated
Barrel: Brass, gold-plated
Spring: Steel, gold-plated or stainless steel** (MC)
Receptacle: Brass, gold-plated

Mounting hole size

in CEM1: ø1,00 - 1,02 mm (.0394-.0401)
in FR4: ø1,01 - 1,03 mm (.0398-.0405)

Available tip styles version GKS-050 ... M

Material	Tip style	Plating	Further versions	
			ø	ø (inch)
2 01		A	ø 0,50 (.020)	
3 02		A	ø 0,60 (.023)	
3 03		A	ø 0,50 (.020)	0,90 (.035)
3 05		A	ø 0,50 (.020)	
3 06		A	ø 0,90 (.035)	
3 07		A	ø 0,50 (.020)	0,90 (.035)
2 14		A	ø 0,50 (.020)	
3 19		A	ø 0,90 (.035)	
2 22*		A	ø 0,40 (.020)	
2 31		A	ø 0,50 (.020)	
2 38		A	ø 0,50 (.020)	
2 77		A	ø 0,50 (.020)	
2 91		A	ø 0,50 (.020)	
2 97		A	ø 0,50 (.020)	

* conical down to ø 0,50 mm

Available tip styles special version GKS-050 ... ML

Material	Tip style	Plating	Further versions	
			ø	ø (inch)
2 91		A	ø 0,50 (.020)	

Total length 49,3 mm (1.941), special designation "ML"

Recommended screw-in torque:
 Min.: 0,5 cNm / Max.: 1 cNm

Note:

The KS-050 ... M receptacle is available pre-wired with 1 m AWG 30 wire (see ordering example). Minimal recommended bending radius: 10 mm (.394).

Ordering example

Series	Tip material 2 = Steel 3 = BeCu	Tip style	Tip diameter (1/100 mm)	Plating A = Gold	Spring force (dN)	Collar height (mm)	Special designation "M", "MC" "ML", "MLC"
--------	---------------------------------------	-----------	----------------------------	---------------------	----------------------	-----------------------	---

Test probe with Total length 47,3 mm (1.862):

G K S 0 5 0 2 9 1 0 5 0 A 1 5 0 3 M

Test probe with Total length 49,3 mm (1.941):

G K S 0 5 0 2 9 1 0 5 0 A 1 5 0 3 M L

Receptacles:

K S - 0 5 0 3 5 M K S - 0 5 0 3 5 M - V - 30

Insertion tool for KS-050 ... M:

S W - K S - 0 8 0

GKS 075 M

Screw-in Test Probe

Grid:

≥ 1,91 mm

≥ 75 Mil

Installation height with KS: 10,5 mm (.413)

Recommended stroke: 4,3 mm (.169)

Mounting and functional dimensions

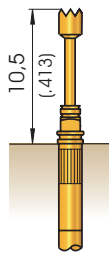
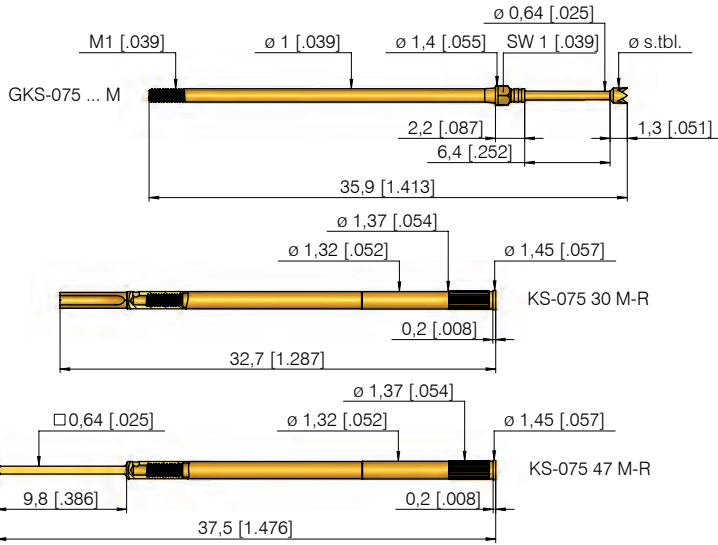

Collar height and installation height

The installation height of the tip is 10,5 mm (.413). The test probe can only be used with a receptacle.

Mechanical data

Working stroke: 4,3 mm (.169)
Maximum stroke: 6,35 mm (.250)
Spring force at work. stroke: 2,0 N (7.2oz)
Alternative: 0,6 N (2.2oz); 1,0 N (3.6oz); 1,5 N (5.4oz); 2,8 N (10.1oz)

Electrical data

Current rating: 3 - 4 A
R_i typical: < 20 mΩ (** < 100 mΩ)

Operating temperature

Standard: -40° up to +80° C
****with spec. desig. "MC":** -100° up to +200° C (2,0 N; 2,8 N)

Materials

Plunger: BeCu or steel, gold-plated
Barrel: Brass, gold-plated
Spring: Steel, gold-plated or stainless steel
 ** (MC)

Mounting hole size

in CEM1 and FR4: ø 1,32 - 1,34 mm (.0520 - .0528)

Recommended screw-in torque:
 Min.: 0,5 cNm / Max.: 1 cNm

Available tip styles

Material	Tip style	Plating	Further versions	
			ø	ø (inch)
0 06*		A		
2 01		A		
3 02		A		
3 03		A		
2 04		A		
3 05		A		
3 05		A		
3 06		A	1,20	(.047)
2 07		A	1,00 1,20	(.039) (.047)
2 09		A		
3 13		A		
2 14		A	0,64 0,80 1,00	(.025) (.031) (.039)
2 17		A		
3 19		A	1,50	(.059)
2 24 ***		A		
2 25		A	1,30	(.051)
2 31		A		
2 77		A		
2 91		A		
2 97		A	0,80	(.031)
2 98		A		

* Tip height: 2,8 mm (.110), total length GKS 1,5 mm (.059) longer than standard
 Further tip styles see GKS-075, shown on page 26/27
 *** higher middle tip plus 0,2 mm

Ordering example

	Series	Tip material 2 = Steel 3 = BeCu	Tip style	Tip diameter (1/100 mm)	Plating A = Gold	Spring force (dN)	Collar height (mm)	Special designation alternative "MC"
Test probe:	G K S	0 7 5	2 0 1	0 6 4	A	1 5	0 2	M
Receptacles:	K S - 0 7 5 3 0 M - R		K S - 0 7 5 4 7 M - R					

Grid:
 ≥ 2,54 mm
 ≥ 100 Mil

Installation height with KS: 8,7 mm (.343)
Recommended stroke: 3,5 mm (.138)

Mounting and functional dimensions

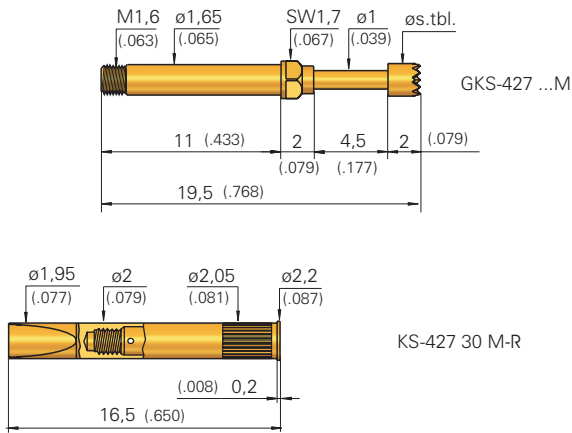

Available tip styles					
Material	Tip style	Plating	Further versions		
			ϕ	ϕ (inch)	
2	01	A	$\phi 1,00$ (.039)		
NEW	3	03	$\phi 2,00$ (.079)		
NEW	3	05	$\phi 0,64$ (.025)	0,80	A
NEW	3	05	$\phi 1,00$ (.039)		
3	06	A	$\phi 2,00$ (.079)	1,30	A
NEW	3	13	$\phi 1,00$ (.039)		
NEW	3	17	$\phi 2,00$ (.079)		

Mechanical data
Working stroke: 3,5 mm (.138)
Maximum stroke: 4,5 mm (.177)
Spring force at work. stroke: 1,5 N (5.4oz)
Alternative: 0,8 N (7.2oz); 2,5 N (9.0oz)

Materials
Plunger: BeCu or steel, gold-plated
Barrel: Brass, gold-plated
Spring: Stainless steel (*MC) or steel, gold-plated
Receptacle: Brass, gold-plated

Recommended screw-in torque:
 Min.: 3 cNm / Max.: 5 cNm

Electrical data
Current rating: 5 - 8 A
R_i typical: < 20 m Ω

Mounting hole size
for KS-427 30 M-R $\phi 2,00 - 2,02$ mm
in CEM1 and FR4: (.0787 - .0795)

Operating temperature
Standard: -40° up to +80° C
*** with special designation "MC":**
 -100° up to +200° C
 1,5 N (5.4oz); 2,5 N (9.0oz)

Ordering example

Series	Tip material 2 = Steel 3 = BeCu	Tip style	Tip diameter (1/100 mm)	Plating A = Gold	Spring force (dN)	Collar height (mm)	Type alternative "MC"
G K S	4 2 7	3	0 6	2 0 0	A	1 5	0 2 M
K S - 4 2 7 3 0 M - R							

Test probe:

Receptacle:

GKS 899 M

Screw-in Step Probes

Grid:

≥ 2,54 mm

≥ 100 Mil

Installation height with KS: 12,8 (.504)

Recommended stroke: 3,5 mm (.138)

Mounting and functional dimensions

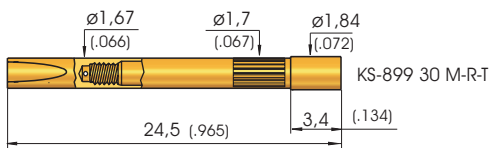
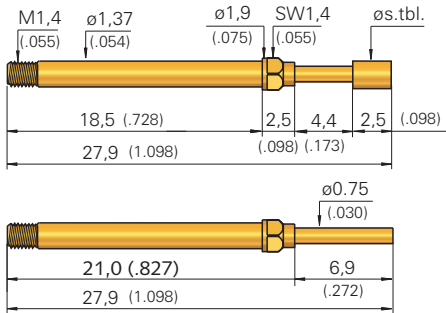

** axially positioned bore hole for leakage test.
Attention: when not assembled correctly, solder can flow inside the receptacle.

Available tip styles

Material	Tip style	Plating	Further versions	
			∅	∅ (inch)
2	01	A		
3	02	A	0,65	(.026)
3	02	A		
3	03	A		
3	05	A	0,65	(.026)
3	06	A	1,00 1,80	(.039) (.071)
3	13	A		

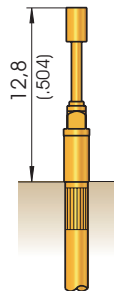

Collar height and installation height

The installation height of the tip is always 12,8 mm (.504). The test probe can only be used with a receptacle.

Mechanical data

Working stroke: 3,5 mm (.138)

Maximum stroke: 4,4 mm (.173)

Spring force at work. stroke: 1,5 N (5.4oz)

Alternative: 0,7 N (2.5oz); 2,5 N (9.0oz)
3,0 N (10.8oz)

Electrical data

Current rating: 3 - 5 A

R_i typical: < 20 mΩ

Operating temperature

Standard: -40° up to +80° C

Materials

Plunger: BeCu or steel, gold-plated

Barrel: Brass, gold-plated

Spring: Steel, gold-plated

Receptacle: Brass, gold-plated

Recommended screw-in torque:
Min.: 2 cNm / Max.: 3 cNm

Mounting hole size

in CEM1 and FR4: ∅ 1,67 - 1,68 mm
(.0657 - .0661)

Ordering example

Series	Tip material 2 = Steel 3 = BeCu	Tip style	Tip diameter (1/100 mm)	Plating A = Gold	Spring force (dN)	Collar height (mm)	Type
--------	---------------------------------------	-----------	----------------------------	---------------------	----------------------	-----------------------	------

Test probe:

G K S 8 9 9 3 0 6 1 3 0 A 1 5 0 2 M

Receptacle for GKS-899 ... M:

K S - 8 9 9 3 0 M - R - T

Receptacle for leakage test **:

K S - 8 9 9 3 0 M - R

Grid:
 ≥ 2,54 mm
 ≥ 100 Mil

Installation height with KS: 10,5/13,6/19,0 mm (.413/.535/.748)
Recommended stroke: 4,0 / 6,4 mm (.157/.252)

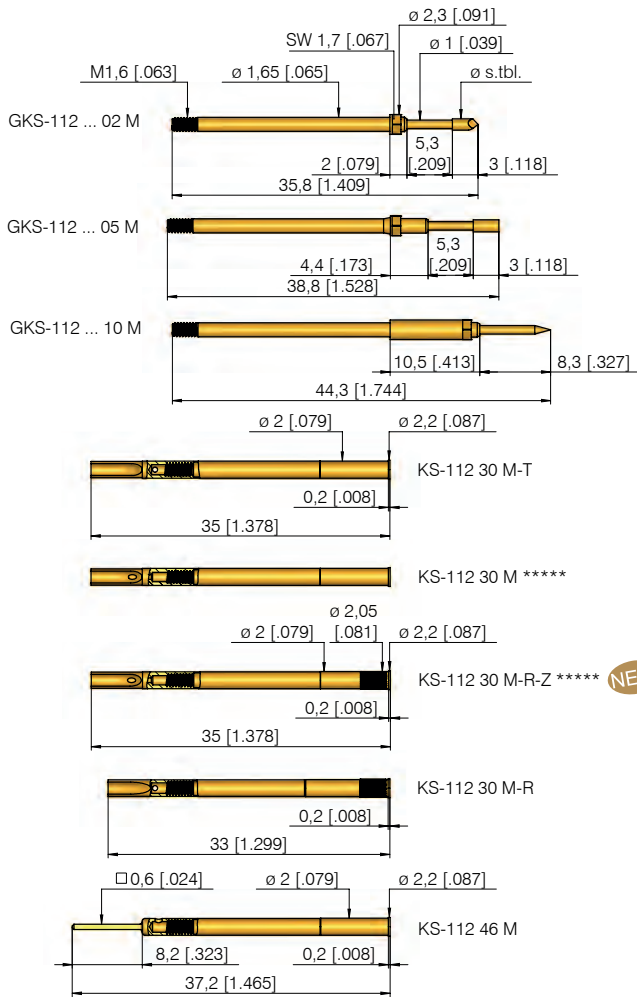

***** axially positioned through-hole for leakage test. Attention: when not assembled correctly, then solder can flow inside the receptacle.

Plug VS-112 M is used instead of a test probe to prevent receptacles being used unnecessarily during maintenance.

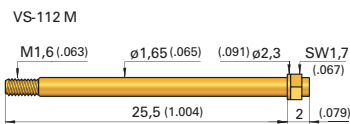

Mechanical data

Working stroke: 4,0 mm (.157)
Maximum stroke: 5,3 mm (.209)
Spring force at work. stroke: 1,5 N (5.4oz)
Alternative: 0,6 (2.1oz); 0,8 (2.9oz); 2,25 (8.1oz); 3,0 (10.8oz); 5,0 N (18.1oz)

Test probes with tip diameter ≤ 1,0 mm (.039) have a maximum stroke of 8,0 mm (.315)
 Exception: 5,0 N-spring (18.1oz): max. stroke is always 5,3 mm (.209)

Operating temperature

Standard: -40° up to +80° C
with spec. design. "MC": -100° up to +200° C (0,8; 1,5; 2,25; 3,0 N)

Collar height	Install. height with KS
02	10,5 mm (.413)
05	13,6 mm (.535)
10	19,0 mm (.748)

Materials

Plunger: BeCu or steel, gold-, rhodium or chemically nickel-plated
Barrel: Brass, gold-plated
Spring: Steel, gold-plated or stainless steel (MC)
Receptacle: Brass, gold-plated

Mounting hole size

for KS-112 xx M and KS-112 xx M-T in CEM1 and FR4: ø 1,98 - 1,99 mm (.0780 - .0783)

for KS-112 xx M-R / M-R-Z in CEM1 and FR4: ø 2,00 - 2,02 mm (.0787 - .0795)

Electrical data

Current rating: 5 - 8 A
R_i typical: < 20 mΩ (with spec. design. "MC" < 100 mΩ)

Available tip styles

Material	Tip style	Plating	Further versions	
			ø	ø (inch)
2	01	R A	ø 1,00 (.039)	0,80 (.031)
3	02 **	A	ø 0,64 (.025)	
3	02	A	ø 0,64 (.025)	
3	02	A	ø 0,80 (.031)	
3	02	A	ø 2,00 (.079)	1,00 (.039) 1,50 (.059)
3	03	A	ø 2,00 (.079)	1,40 (.055) 1,80 (.071)
2	04	R	ø 2,00 (.079)	1,30 (.051)
3	05 **	A	ø 0,63 (.025)	
3	05 **	A	ø 0,64 (.025)	
3	05	A	ø 0,64 (.025)	0,80 (.031)
3	05	A	ø 2,00 (.079)	1,00 (.039) 1,40 (.055) 2,30 (.091)
0	06*	A	ø 2,30 (.091)	
3	06	A	ø 2,00 (.079)	
3	06	R	ø 2,00 (.079)	1,30 (.051) 1,50 (.059) 1,80 (.071) 2,50 (.098)
2	07	R A	ø 2,00 (.079)	1,30 A (.051)
2	09 ***	N	ø 0,60 (.024)	
2	14	A	ø 1,30 (.051)	1,30 R (.051)
2	17	N	ø 1,75 (.069)	2,00 R (.079)
3	19	A	ø 1,80 (.071)	2,00 (.079)

* also available as tip style 0 02 and 0 03
 Installation height plus 0,8 mm (.031)

** plunger with defined wobble, spec. designation... MT

*** pressed-in steel point in base plunger made of brass

**** tip style with special designation "M-30"

Collar height and installation height

The installation height of the tip (measured with the receptacle) is determined by the collar height. The test probe can only be used with a receptacle.

Recommended screw-in torque:
 Min.: 3 cNm / Max.: 5 cNm

Ordering example

Series	Tip material	Tip style	Tip diameter (1/100 mm)	Plating	Spring force (dN)	Collar height (mm)	Special designation alternative
M1	0 = Delrin 2 = Steel 3 = BeCu			A = Gold N = Nickel R = Rhodium			"MC", "MT", "M-30" (see ****)

Test probe:

G K S 1 1 2 2 0 4 1 3 0 R 1 5 0 2 M 30

Plug:

V S 1 1 2 M

All specifications are subject to change without prior notification

GKS 204 M

Long-stroke Test Probe for Dual-stage Fixture

Grid:

≥ 2,54 mm

≥ 100 Mil

Installation height with KS: 23,2 mm (.913)

Recommended stroke: 8,0 mm (.315)

Mounting and functional dimensions

GKS-204 ... M

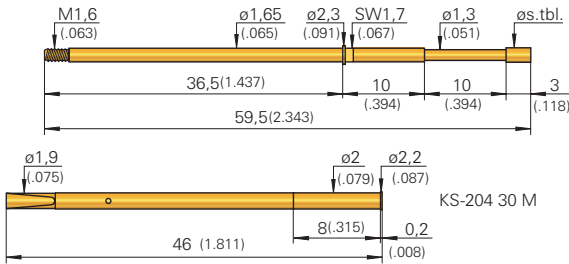

Collar height and installation height

To adjust the installation height of the tip (dimension without receptacle), use test probes with alternative collar heights.

Collar height	Installation height without receptacle
10 M	23,0 mm (.906)

Mechanical data

Working stroke: 8,0 mm (.315)

Maximum stroke: 10,0 mm (.394)

Spring force at work. stroke: 1,5 N (5.4oz)

Alternative: 0,8 N (2.9oz); 3,0 N (10.8oz)

Materials

Plunger: BeCu or steel, gold-plated, rhodium- or chemically nickel-plated

Barrel: Nickel-silver or Brass, gold-plated

Spring: Steel, gold-plated

Receptacle: Brass, gold-plated

Electrical data

Current rating: 5 - 8 A

R_i typical: < 20 mΩ

Mounting hole size

for KS-204 30 M: ∅ 1,99 mm (.0783)

Operating temperature

Standard: -40° up to +80° C

Available tip styles

Material	Tip style	Plating	Further versions	
			∅	∅ (inch)
2	01	R	∅ 1,30 (.051)	
3	02	A	∅ 1,80 (.071)	
3	03	A	∅ 1,80 (.071)	
2	04	A	∅ 1,30 (.051)	
3	05	A	∅ 1,30 (.051)	
2	06	R	∅ 1,80 (.071)	
2	07	A	∅ 1,30 (.051)	
2	09*	N	∅ 0,70 (.028)	0,70 G (.028)
2	14	A	∅ 1,30 (.051)	
2	15*	A	∅ 1,80 (.071)	
2	24	R	∅ 2,00 (.079)	
2	91	N	∅ 1,30 (.051)	1,30 (.051)
2	93	A	∅ 1,60 (.063)	

* pressed-in steel tip in base plunger made of brass

Recommended screw-in torque:
Min.: 3 cNm / Max.: 5 cNm

Ordering example

	Series	Tip material 2 = Steel 3 = BeCu	Tip style	Tip diameter (1/100 mm)	Plating A = Gold R = Rhodium N = Nickel	Spring force (dN)	Collar height (mm)	Type "M"
Test probe:	G K S	2	0 4	1 3 0	A	1 5	1 0	M
Receptacle:	K S - 2 0 4 3 0 M							

Grid:
 ≥ 4,00 mm
 ≥ 160 Mil

Installation height: 7,3 / 8,9 mm (.287 / .350)
Recommended stroke: 2,8 mm (.110)

Mounting and functional dimensions

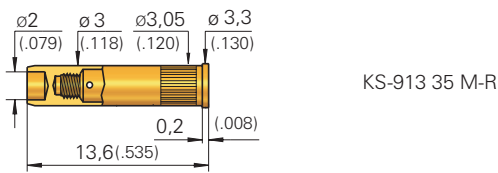
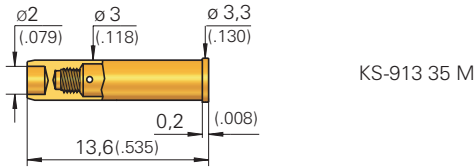
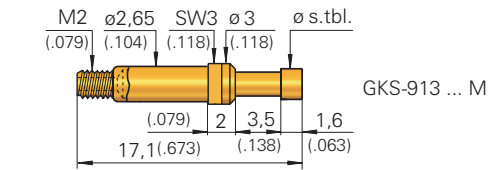

Available tip styles

Material	Tip style	Plating	Further versions	
			∅	∅ (inch)
1 02		A	3,50	(.138)
3 03		A		
3 05		A		
3 06*		A		
3 06		A	3,50 R 2,30 R	(.138) (.091)
3 08		R		
3 58**		R		

* see table collar height and installation height
 ** see table collar height and installation height

Collar height and installation height

The installation height of the tip is determined by the collar height.

Collar height	Tip style	Install. height without KS	max. stroke
02	02/05/06/08	7,1 mm (.280)	3,5 mm (.138)
02	06 180*	7,1 mm (.280)	3,2 mm (.126)
02	58**	8,7 mm (.343)	3,3 mm (.130)

Mechanical data

Working stroke: 2,8 mm (.110)
Maximum stroke: see table
Spring force at work. stroke: 1,5 N (5.4oz)
Alternative: 0,8 N (2.9oz); 2,5 N (9.0oz)

Electrical data

Current rating: 5 - 8 A
R_i typical: < 20 mΩ (***)
 *** Spring force < 1,5 N not recommended for high-current applications

Operating temperature

Standard: -40° up to +80° C
 *** with spec. design. "C": -100° up to +200° C (1,5 N)

Materials

Plunger: Brass or BeCu, gold- or rhodium-plated
Barrel: Brass, gold-plated
Spring: Steel, gold-plated or stainless steel*** (C)
Receptacle: Brass, gold-plated

Mounting hole size

in CEM1 and FR4:
with KS-913 35 M: ∅ 2,98 - 2,99 mm (.1173 - .1177)
for KS-913 35 M-R in CEM1 and FR4: ∅ 3,00 - 3,02 mm (.1181 - .1189)

For applications up to 30 A:
 see HSS-520 (M) shown on page 87

Recommended screw-in torque:
 Min.: 5 cNm / Max.: 10 cNm

Ordering example

Series	Tip material	Tip style	Tip diameter (1/100 mm)	Plating	Spring force (dN)	Collar height (mm)	Type
	1 = Brass 3 = BeCu			A = Gold R = Rhodium			M, MC

Test probe:

G K S 9 1 3 3 0 8 2 3 0 R 1 5 0 2 M

Receptacle:

K S - 9 1 3 3 5 M K S - 9 1 3 3 5 M - R

GKS 113 M

Screw-in Test Probes

Grid:

≥ 4,0 mm

≥ 160 Mil

Installation height with KS: 10,5 mm (.413)

Recommended stroke: 4,0 mm (.157)

Mounting and functional dimensions

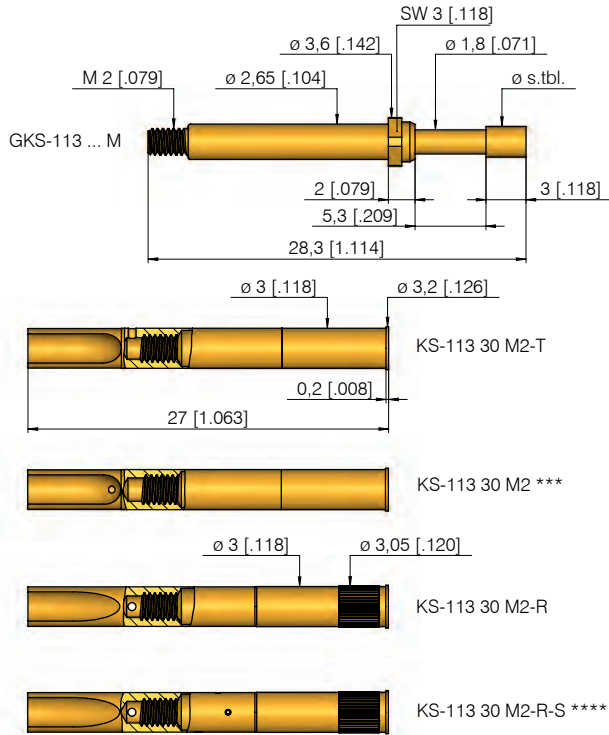

*** axially positioned through-hole for leakage test.
Attention: when not assembled correctly, solder can flow inside the receptacle.

**** Additional crimping points for self locking

Collar height and installation height

The installation height of the tip is always 10,5 mm (.413). The test probe can only be used with a receptacle.

Mechanical data

Working stroke: 4,0 mm (.157)
Maximum stroke: 5,3 mm (.209)
Spring force at work. stroke: 1,5 N (5.4oz)
Alternative: 0,3 N (1.1oz); 0,6 N (2.2oz);
 1,0 N (3.6oz); 2,25 (8.1oz); 3,0 N (10.8oz);
 5,0 N (18.1oz)

Electrical data

Current rating: 5 - 8 A
R_i typical: < 30 mΩ
 (** < 100 mΩ)

Operating temperature

Standard: -40° up to +80° C
****with spec. design. "MC":**
 -100° up to +200° C
 (1,5 N; 2,25 N; 3,0 N)

Recommended screw-in torque:
 Min.: 10 cNm / Max.: 20 cNm

Materials

Plunger: BeCu or Steel, gold-, rhodium or chemically nickel-plated
Barrel: Brass, gold-plated
Spring: Steel, gold-plated or stainless steel** (MC)
Receptacle: Brass, gold-plated

Mounting hole size

for KS-113 30 M2 and KS-113 30 M2-T
 in CEM1: ø 2,98 - 3,00 mm (.1173 - .1181)
 in FR4: ø 2,99 - 3,01 mm (.1177 - .1185)
for KS-113 30 M2-R and KS-113 M2-R-S
 in CEM1 and FR4: ø 3,00 - 3,02 mm (.1181 - .1189)

Available tip styles

Material	Tip style	Plating	Further versions	
			ø	ø (inch)
2	01	R	ø 1,80 (.071)	
3	02	A	ø 1,40 (.055) ø 2,30 (.091)	0,80 (.031) 1,00 (.039) 1,80 (.071) 3,00 (.118) 4,00 (.157)
2	03	A	ø 3,00 (.118)	
3	03	A	ø 2,30 (.091)	4,00 R (.157)
2	04	R	ø 2,30 (.091)	1,80 A (.071) 3,00 (.118)
3	05	A	ø 2,30 (.091)	0,80 (.031) 1,40 (.055) 3,00 R (.118)
3	55	R	ø 3,00 (.118)	
	Tip 4 mm (.157) longer			
3	06	A	ø 3,00 (.118)	1,60 (.063) 2,30 (.091) 4,00 (.157) 8,00 (.315)
3	06	R	ø 2,30 (.091)	2,50 (.098) 3,00 (.118) 3,50 (.138) 4,00 (.157) 6,00 (.236)
2	07	A	ø 3,00 (.118)	
3	07	R	ø 4,20 (.165)	
3	12	A	ø 1,80 (.071)	
3	13	R	ø 1,80 (.071)	
2	14	R	ø 1,40 (.055)	
2	15*	A	ø 1,00 (.039)	
	Tip 2,5 mm (.098) longer			
2	17	R	ø 2,30 (.091)	1,80 (.071) 3,00 A (.118)
3	19	A	ø 4,00 (.157)	3,00 (.118)
3	72	A	ø 1,80 (.071)	
2	87	N	ø 2,60 (.102)	4,00 (.157)
2	88	A	ø 2,30 (.091)	

* pressed-in steel tip in base plunger made of brass

Ordering example

Series	Tip material	Tip style	Tip diameter (1/100 mm)	Plating	Spring force (dN)	Collar height (mm)	Special designation alternative "MC"
	2 = Steel 3 = BeCu			A = Gold N = Nickel R = Rhodium			

Test probe:

G K S 1 1 3 3 0 6 2 3 0 R 1 5 0 2 M

Receptacles for GKS-113 ... M:

K S - 1 1 3 3 0 M 2 - R K S - 1 1 3 3 0 M 2 - T

Receptacles for leakage test***:

K S - 1 1 3 3 0 M 2

Grid:
 ≥ 4,00 mm
 ≥ 160 Mil

Installation height with KS: 12,5 mm (.492)
Recommended stroke: 4,8 mm (.189)

Mounting and functional dimensions

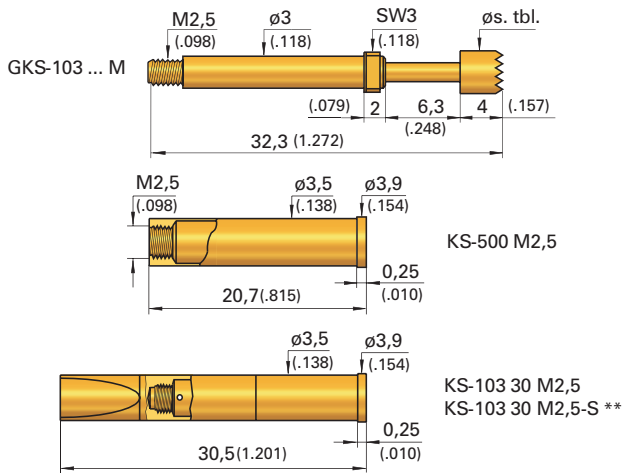

Available tip styles

Material	Tip style	Plating	Further versions	
			∅	∅ (inch)
2 01		A		
1 02		A	4,00	(.157)
2 02		A		
1 03		A	4,00	(.157)
2 04		A	4,00	(.157)
1 05		A	4,00	(.157)
2 06		A	4,00 6,50 9,00	(.157) (.256) (.354)

Collar height and installation height

The installation height of the tip is determined by the collar height.

Collar height	Installation height without receptacle
02	12,3 mm (.484)

Mechanical data

Working stroke: 4,8 mm (.189)
Maximum stroke: 6,0 mm (.236)
Spring force at work. stroke: 1,5 N (5.4oz)
Alternative: 0,8 N (2.9oz); 3,0 N (10.8oz), 5,0 N (18.1oz)

Electrical data

Current rating: 5 - 8 A
R_i typical: < 30 mΩ (* < 100 mΩ)

Operating temperature

Standard: -40° bis +80° C
***with spec. designation "C":**
 -100° up to +200° C (1,5 N; 3,0 N; 5,0 N)

Materials

Plunger: Steel or Brass, gold-plated
Barrel: Brass, gold-plated
Spring: Steel, gold-plated or stainless steel* (C)
Receptacle: Brass, gold-plated

Mounting hole size

with receptacle: ∅ 3,48 - 3,49 mm (.1370 - .1374)
without receptacle: ∅ 3,00 mm (.1181)

Note:

The receptacle can be used from grid size 4,50 mm (177 Mil) upwards.

** KS-103 30 M2,5-S:

The test probes is secured in the receptacle by means of a crimp.

Recommended screw-in torque:
 Min.: 10 cNm / Max.: 20 cNm

Ordering example

Series	Tip material 1 = Brass 2 = Steel	Tip style	Tip diameter (1/100 mm)	Plating A = Gold	Spring force (dN)	Collar height (mm)	Type alternative "M" "MC"
Test probe:	G K S	1 0 3	2 0 1	1 8 0	A	1 5	0 2 M
Receptacles:	K S - 1 0 3 3 0 M 2.5		K S - 1 0 3 3 0 M 2.5 - S		K S - 5 0 0 M 2.5		

GKS 503 M

Test Probe with Continuous Plunger

Grid:

≥ 4,00 mm

≥ 160 Mil

Installation height with KS: 13,2 mm (.520)

Recommended stroke: 5,6 mm (.220)

Mounting and functional dimensions

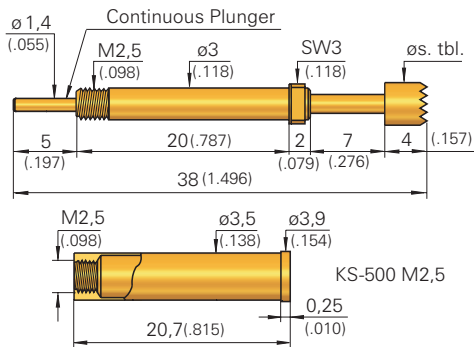

Available tip styles

Material	Tip style	Plating	Further versions	
			∅	∅ (inch)
2	01	R		
3	03	A		
3	04	R		
2	05	R		
3	06	R A	3,00 R	(.118)
2	06	R		

Collar height and installation height

The installation height of the tip is determined by the collar height.

Collar height	Installation height without receptacle
02	13,0 mm (.512)

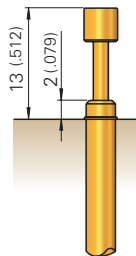

Mechanical data

Working stroke: 5,6 mm (.220)
Maximum stroke: 7,0 mm (.276)
Spring force at work. stroke: 1,5 N (5.4oz)
Alternative: 3,0 N (10.8oz), 5,0 N (** (18.1oz))

Electrical data

Current rating, conn. to plunger: 12-15 A
Current rating, connection to KS: 5 - 8 A
R_i typical, connection to plunger: < 10 mΩ
R_i typical, connection to KS: < 30 mΩ
 (** < 100 mΩ)

Operating temperature

Standard: -40° up to +80° C
**** with 5,0 N spring:** -100° up to +200° C

Materials

Plunger: BeCu or Steel, gold-, or rhodium-plated
Barrel: Brass, gold-plated
Spring: Steel, gold-plated or stainless steel**
Receptacle: Brass, gold-plated

Mounting hole size

with receptacle: ∅ 3,48 - 3,49 mm (.1370 - .1374)
without receptacle: ∅ 3,00 mm (.1181)

Note:

The receptacle can be used from grid size 4,50 mm (180 Mil) upwards.

Recommended screw-in torque:
 Min.: 10 cNm / Max.: 20 cNm

Ordering example

Series	Tip material	Tip style	Tip diameter (1/100 mm)	Plating	Spring force (dN)	Collar height (mm)	Type "M"
	2 = Steel 3 = BeCu			A = Gold R = Rhodium			

Test probe:

G K S 5 0 3 2 0 1 1 8 0 R 1 5 0 2 M

Receptacles:

K S - 5 0 0 M 2.5

Lamellar plug:

(for plugging onto the end of the plunger)

S E - 5 0 3

Grid:
 ≥ 4,50 mm
 ≥ 177 Mil

Installation height with KS: 13,2 mm (.520)
Recommended stroke: 5,6 mm (.220)

Mounting and functional dimensions

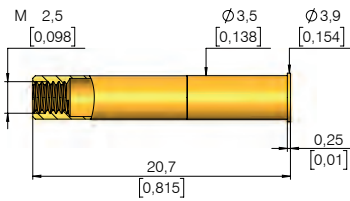
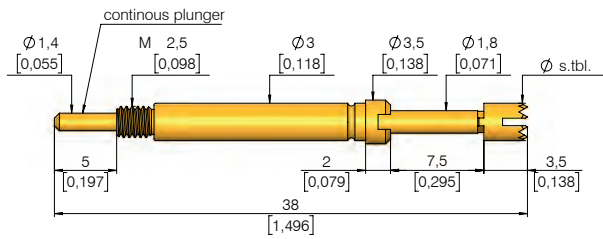

Available tip styles

Material	Tip style	Plating	Further versions	
			∅	∅ (inch)
3	06	A	4,00 (.157)	A

Collar height and installation height

The installation height of the tip is always 13,0 mm (.512). The test probe can only be used with a receptacle.

Collar height	Installation height without KS
02	13,0 mm (.512)

Mechanical data

Working stroke: 5,6 mm (.220)
Maximum stroke: 7,0 mm (.276)
Spring force at work. stroke: 1,5 N (5.4oz)
Alternative: 3,0 N (10.8oz); 5,0 N (18.1oz)

Materials

Plunger: BeCu, gold-plated
Barrel: Brass, gold-plated
Spring: Steel, gold-plated
Receptacle: Brass, gold-plated

Recommended screw-in torque:
 Min.: 10 cNm / Max.: 20 cNm

Electrical data

Current rating
Connection to plunger: 12 - 15 A
Connection to KS: 5 - 8 A
R_j typical:
Connection to plunger: < 10 mΩ
Connection to KS: < 30 mΩ

Mounting hole size

in CEM1 and FR4: ∅ 3,48 - 3,49 mm (.1370 - .1374)

Operating temperature

Standard: -40° up to +80° C

Ordering example

Series	Tip material 3 = BeCu	Tip style	Tip diameter (1/100 mm)	Plating A = Gold	Spring force (dN)	Collar height (mm)	Type
--------	--------------------------	-----------	----------------------------	---------------------	----------------------	-----------------------	------

Test probe:

G K S 5 0 0 3 0 6 3 0 0 A 1 5 0 2 M

Receptacle:

K S - 5 0 0 M 2,5

GKS 854 M

Screw-in Test Probe

Grid:

≥ 5,08 mm

≥ 200 Mil

Installation height with KS: 10,8 mm (.425)

Recommended stroke: 4,0 mm (.157)

Mounting and functional dimensions

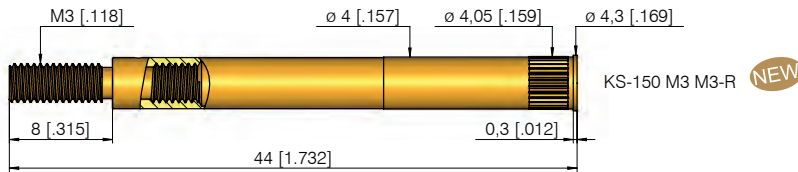
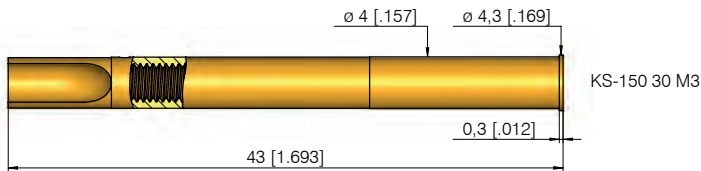
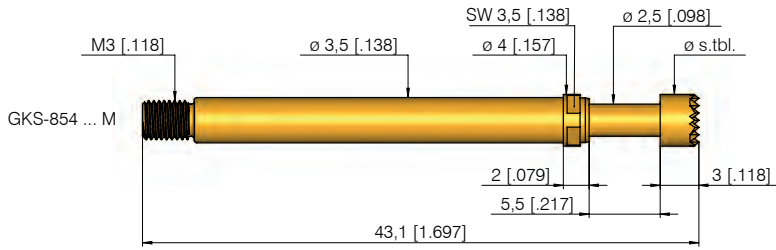

Available tip styles

Material	Tip style	Plating	Further versions	
			∅	∅ (inch)
3 19		A		
3 06		A		

Collar height and installation height

The installation height of the tip (measured with the receptacle) is determined by the collar height. The test probe can only be used with a receptacle.

Collar height	Installation height with receptacle
02	10,8 mm

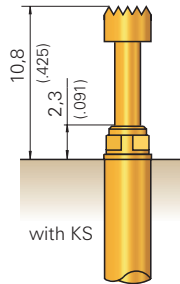

Mechanical data

Working stroke: 4,4 mm (.173)
Maximum stroke: 5,5 mm (.217)
Spring forces at work. Str.: 3,0 N (10.8oz)
Alternative: 5,0 N (18.1oz)

Electrical data

Current rating: 10 - 12 A
R_i typical: < 20 mΩ
 (* < 100 mΩ)

Operating temperature

Standard: -40° up to +80° C
***with spec. design. "C":** -100° up to +200° C (1,5; 5,0 N)

Materials

Plunger: BeCu, gold-plated
Barrel: Brass, gold-plated
Spring: Steel, gold-plated or stainless steel * (C)
Receptacle: Brass, gold-plated

Recommended screw-in torque:
 Min.: 10 cNm / Max.: 20 cNm

Mounting hole size

for KS-150 30 M3 in CEM1 and FR4: ∅ 3,99 mm (.1571)
for KS-150 30 M3-R + KS-150 M3 M3-R in CEM1 and FR4: ∅ 4,00 - 4,02 mm (.1575 - .1583)

Ordering example

Series	Tip material 3 = BeCu	Tip style	Tip diameter (1/100 mm)	Plating A = Gold	Spring force (dN)	Collar height (mm)	Special designation "M", "MC"
--------	--------------------------	-----------	----------------------------	---------------------	----------------------	-----------------------	----------------------------------

Test probe:

G K S 8 5 4 3 1 9 4 0 0 A 3 0 0 2 M

Receptacles:

K S - 1 5 0 3 0 M 3 K S - 1 5 0 3 0 M 3 - R K S - 1 5 0 M 3 M 3 - R

Grid:
 ≥ 2,54 mm
 ≥ 100 Mil

Installation height with KS: 25,2 mm (.992)
 Recommended stroke: 12,0 mm (.472)

Mounting and functional dimensions

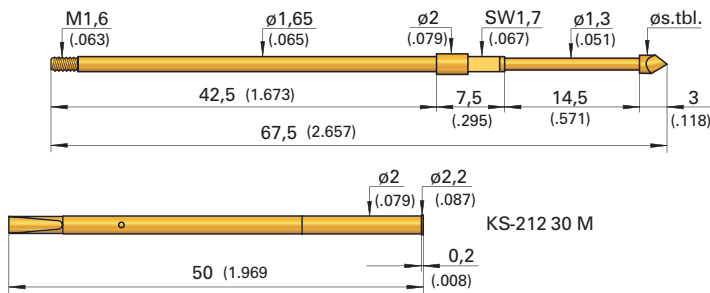

		Available tip styles			
Material	Tip style	Plating	Further versions		
			∅	∅ (inch)	
3	06	A	∅ 2,00 (.079)		
3	07	A	∅ 2,00 (.079)	1,50 (.059)	

Collar height and installation height

The installation height of the tip (measured with the receptacle) is determined by the collar height. The test probe can only be used with a receptacle.

Collar height	Installation height without KS
07	25 mm (.984)

Mechanical data

Working stroke: 12 mm (.472)
Maximum stroke: 14,5 mm (.571)
Spring force at work. stroke: 3 N (10.8oz)

Materials

Plunger: BeCu, gold-plated
Barrel: Brass, gold-plated
Spring: Steel, gold-plated
Receptacle: Brass, gold-plated

Recommended screw-in torque:
 Min.: 3 cNm / Max.: 5 cNm

Electrical data

Current rating: 2 - 3 A
R_i typical: < 20 mΩ

Mounting hole size

in CEM1 and FR4: ∅ 1,99 mm (.0783)

Operating temperature

Standard: -40° up to +80° C

Ordering example

Series	Tip material	Tip style	Tip diameter (1/100 mm)	Plating	Spring force (dN)	Collar height (mm)	Special designation
	3 = BeCu			A = Gold			

Test probe:

G K S | 2 1 2 | 3 | 0 7 | 2 0 0 | A | 3 0 | 0 7 | M

Receptacle:

K S - 2 1 2 3 0 M

GKS 313 M

Screw-in Test Probe

Grid:

≥ 4,50 mm

≥ 177 Mil

Installation height with KS: 19,5 / 25,0 mm (.768 / .984)

Recommended stroke: 12,0 mm (.472)

Mounting and functional dimensions

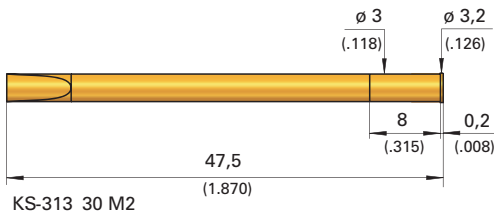
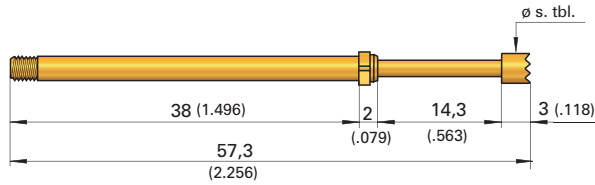
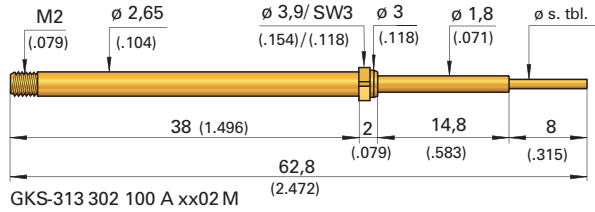

Available tip styles

Material	Tip style	Plating	Further versions	
			∅	∅ (inch)
3	02	A	∅ 1,00 (.039)	
3	06	A	∅ 3,00 (.118)	
3	17	R	∅ 2,00 (.079)	

Collar height and installation height

The installation height of the tip (measured with the receptacle) is determined by the collar height. The test probe can only be used with a receptacle.

Collar height	Tip style	Installation height with KS
02	02	25,0 mm (.984)
02	06 / 17	19,5 mm (.768)

Mechanical data

Working stroke: 12 mm (.472)
Maximum stroke: 14,3 mm (.563)
Spring forces at work. stroke: 1,5 N (5.4oz)
Alternative: 3,0 N (10.8oz)

Materials

Plunger: BeCu, gold- or rhodium-plated
Barrel: Brass, gold-plated
Spring: Steel, gold-plated
Receptacle: Brass, gold-plated

Recommended screw-in torque:
 Min.: 10 cNm / Max.: 20 cNm

Electrical data

Current rating: 3 - 5 A
R_i typical: < 30 mΩ

Mounting hole size

in CEM1 and FR4: ∅ 2,99 mm (.1177)

Operating temperature

Standard: -40° up to +80° C

Ordering example

Series	Tip material	Tip style	Tip diameter (1/100 mm)	Plating	Spring force (dN)	Collar height (mm)	Special designation
	3 = BeCu			A = Gold			

Test probe:

G K S 3 1 3 3 0 2 1 0 0 A 3 0 0 2 M

Receptacle:

K S - 3 1 3 3 0 M 2

Grid:
 ≥ 2,54 mm
 ≥ 100 Mil

Installation height with KS: see table
Recommended stroke: 3,5 mm (.138)

Mounting and functional dimensions

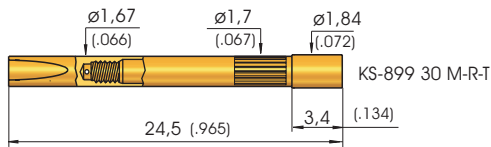
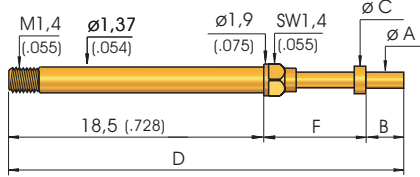

** axially positioned through-hole for leakage test. Attention: when not assembled correctly, then solder can flow inside the receptacle.

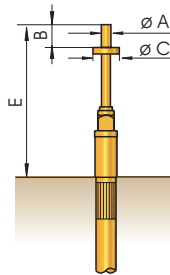

Collar height and installation height
 Installation height shown in table below.
 The test probe can only be used with a receptacle.

Material		Tip style	Plating	Further versions	
				Ø	Ø (inch)
3	02		Ø s. table	A	
3	05		Ø s. table	A	
3	05 G *		Ø s. table	A	

* special designation "G" at the end of part number

Part No.	A Tip-Ø mm	B Tip length mm	C Disk-Ø mm	D Total length mm	E Install.height with KS mm	F Disk height without KS mm	Working stroke mm	Max. stroke mm	* Tools (insertion bits)
T-899 302 065 210 150 A 1502 M	0,65 (.026)	2,1 (.083)	1,5 (.059)	28,0 (1.102)	12,9 (.508)	7,4 (.291)	3,5 (.138)	4,4 (.173)	BIT-GKS-899 M-B
T-899 305 065 280 150 A 1502 M	0,65 (.026)	2,8 (.110)	1,5 (.059)	28,7 (1.130)	13,6 (.535)	7,4 (.291)	3,5 (.138)	4,4 (.173)	BIT-GKS-899 M-B
T-899 305 065 400 150 A 1502 M	0,65 (.026)	4,0 (.158)	1,5 (.059)	29,9 (1.177)	14,8 (.583)	7,4 (.291)	3,5 (.138)	4,4 (.173)	BIT-GKS-899 M-B
T-899 305 070 400 150 A 1502 M	0,70 (.028)	4,0 (.158)	1,5 (.059)	29,9 (1.177)	14,8 (.583)	7,4 (.291)	3,5 (.138)	4,4 (.173)	BIT-GKS-899 M-B
T-899 305 065 270 150 A 1502 MG	0,65 (.026)	2,7 (.106)	1,5 (.059)	27,1 (1.067)	12,0 (.472)	5,9 (.232)	2,0 (.079)	2,75 (.110)	BIT-GKS-899 M-B
T-899 305 065 340 150 A 1502 MG	0,65 (.026)	3,4 (.134)	1,5 (.059)	27,8 (1.095)	12,7 (.500)	5,9 (.232)	2,0 (.079)	2,75 (.110)	BIT-GKS-899 M-B

Mechanical data
Working stroke: 3,5 mm (.138)
Maximum stroke: 4,4 mm (.173)
Spring force at work. stroke: 1,5 N (5.4oz)
Alternative: 0,7 N (2.5oz); 3,0 N (10.8oz)

Materials
Plunger: Steel or BeCu, gold-plated
Barrel: Brass, gold-plated
Spring: Steel, gold-plated
Receptacle: Brass, gold-plated

Recommended screw-in torque: *
 Min.: 2 cNm / Max.: 3 cNm

Electrical data
Current rating: 3 - 5 A
R_i typical: < 20 mΩ

Mounting hole size
in CEM1 and FR4: ø 1,67 - 1,68 mm (.0657 - .0661)

Operating temperature
Standard: -40° up to +80° C

Ordering example

Series	Tip materials	Tip style	Tip-Ø (1/100 mm) (A)	Tip length (1/100 mm) (B)	Disk-Ø (1/100 mm) (C)	Plating A = Gold	Spring force (dN)	Collar height (mm)	Special designation alternative "MG"
3	BeCu								

Test probe: **T 899 3 02 065 210 150 A 15 02 M**
 Receptacle for T-899 ... M: **KS - 899 30 M - R - T**
 Receptacle for leakage test **: **KS - 899 30 M - R**

T-112 M / T-912 M

Screw-in Step Probes

Grid:

≥ 2,54 mm (dependent on max. tip diameter)

≥ 100 Mil (dependent on max. tip diameter)

Installation height with KS: see table

Recommended stroke: 4,0 mm (.157)

Mounting and functional dimensions

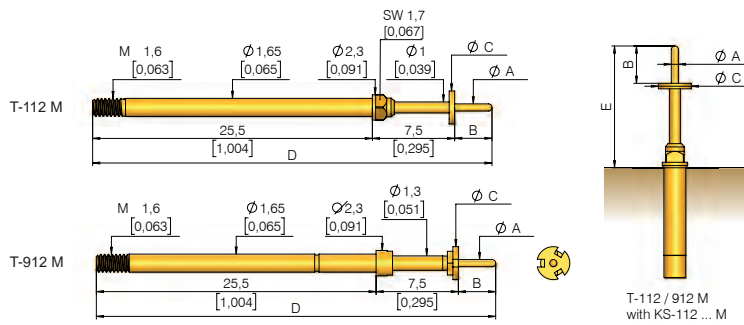

Available tip styles T-112 M

Material	Tip style	Plating	Further versions	
			Ø	Ø (inch)
3 02		A		
3 05		A		
3 05 G*		A		

* Special designation "G" at end of part number

Mechanical data

Working stroke: 4,0 mm (.157)

Maximum stroke: 5,0 mm (.197)

Spring force at work. stroke: 1,5 N (5.4oz)

Alternative: 0,6 N (2.1oz); 0,8 N (2.9oz);
2,25 N (8.1oz); 3,0 N (10.8oz);
5,0 N (18.1oz)

Materials

Plunger: BeCu, gold-plated

Barrel: Brass, gold-plated

Spring: Steel, gold-plated
or stainless steel (MC on request)

Note:

The T-112 M / T-912 M is screwed into KS-112 M, see page 125.

Operating temperature

Standard: -40° up to +80° C

Electrical data

Current rating: 5 - 8 A

R_i typical: < 20 mΩ

Recommended screw-in torque:*

Min.: 3 cNm / Max.: 5 cNm

Available tip styles T-912 M

Material	Tip style	Plating	Further versions	
			Ø	Ø (inch)
3 02		A		
3 05		A		

Part number	A Tip-Ø mm (inch)	B Tip length mm (inch)	C Disk-Ø mm (inch)	D Total length mm (inch)	E Install. height with KS mm (inch)	* Tool (insertion bits)
T-912 302 050 150 210 A 1502 M	0,5 (.020)	1,5 (.059)	2,1 (.083)	34,5 (1.358)	9,2 (.362)	BIT-T-912 M
T-112 302 065 300 100 A 1502 M	0,65 (.026)	3,0 (.118)	1,0 (.039)	36,0 (1.417)	10,7 (.421)	BIT-GKS-112 M-B
T-912 302 070 150 210 A 1502 M	0,7 (.028)	1,5 (.059)	2,1 (.083)	34,5 (1.358)	9,2 (.362)	BIT-T-912 M
T-112 302 070 200 180 A 1502 M	0,7 (.028)	2,0 (.079)	1,8 (.071)	35,0 (1.378)	9,7 (.382)	BIT-GKS-112 M-B
T-912 302 070 200 210 A 1502 M	0,7 (.028)	2,0 (.079)	2,1 (.083)	35,0 (1.378)	9,7 (.382)	BIT-T-912 M
T-112 302 080 320 180 A 1502 M	0,8 (.031)	3,2 (.126)	1,8 (.071)	36,2 (1.425)	10,9 (.429)	BIT-GKS-112 M-B
T-912 302 080 320 210 A 1502 M	0,8 (.031)	3,2 (.126)	2,1 (.083)	36,2 (1.425)	10,9 (.429)	BIT-T-912 M
T-912 302 100 170 250 A 1502 M	1,0 (.039)	1,7 (.067)	2,5 (.098)	34,7 (1.366)	9,4 (.370)	BIT-T-912 M
T-912 302 100 180 250 A 1502 M	1,0 (.039)	1,8 (.071)	2,5 (.098)	34,8 (1.370)	9,5 (.374)	BIT-T-912 M
T-912 302 100 200 210 A 1502 M	1,0 (.039)	2,0 (.079)	2,1 (.083)	35,0 (1.378)	9,7 (.382)	BIT-T-912 M
T-912 302 100 200 250 A 1502 M	1,0 (.039)	2,0 (.079)	2,5 (.098)	35,0 (1.378)	9,7 (.382)	BIT-T-912 M
T-112 302 100 250 180 A 1502 M	1,0 (.039)	2,5 (.098)	1,8 (.071)	35,5 (1.398)	10,2 (.402)	BIT-GKS-112 M-B
T-912 302 100 250 210 A 1502 M	1,0 (.039)	2,5 (.098)	2,1 (.083)	35,5 (1.398)	10,2 (.402)	BIT-T-912 M
T-112 302 100 300 180 A 1502 M	1,0 (.039)	3,0 (.118)	1,8 (.071)	36,0 (1.417)	10,7 (.421)	BIT-GKS-112 M-B
T-912 302 100 300 210 A 1502 M	1,0 (.039)	3,0 (.118)	2,1 (.083)	36,0 (1.417)	10,7 (.421)	BIT-T-912 M
T-912 302 100 300 250 A 1502 M	1,0 (.039)	3,0 (.118)	2,5 (.098)	36,0 (1.417)	10,7 (.421)	BIT-T-912 M
T-112 302 100 320 200 A 1502 M	1,0 (.039)	3,2 (.126)	2,0 (.079)	36,2 (1.425)	10,9 (.429)	BIT-GKS-112 M-B
T-112 302 100 330 230 A 1502 M	1,0 (.039)	3,3 (.130)	2,3 (.091)	36,3 (1.429)	11,0 (.433)	BIT-GKS-112 M
T-912 302 100 330 230 A 1502 M	1,0 (.039)	3,3 (.130)	2,3 (.091)	36,3 (1.429)	11,0 (.433)	BIT-T-912 M
T-112 302 100 350 250 A 1502 M	1,0 (.039)	3,5 (.138)	2,5 (.098)	36,5 (1.437)	11,2 (.441)	BIT-GKS-112 M
T-912 302 100 350 250 A 1502 M	1,0 (.039)	3,5 (.138)	2,5 (.098)	36,5 (1.437)	11,2 (.441)	BIT-T-912 M
T-112 302 102 318 245 A 1502 M	1,02 (.039)	3,18 (.126)	2,45 (.098)	36,18 (1.425)	10,88 (.429)	BIT-GKS-112 M
T-912 302 120 120 250 A 1502 M	1,2 (.047)	1,2 (.047)	2,5 (.098)	34,2 (1.347)	8,9 (.350)	BIT-T-912 M
T-112 302 120 200 190 A 1502 M	1,2 (.047)	2,0 (.079)	1,9 (.075)	35,0 (1.378)	9,7 (.382)	BIT-GKS-112 M-B
T-912 302 120 200 210 A 1502 M	1,2 (.047)	2,0 (.079)	2,1 (.083)	35,0 (1.378)	9,7 (.392)	BIT-T-912 M
T-912 302 130 210 250 A 1502 M	1,3 (.051)	2,1 (.083)	2,5 (.098)	35,1 (1.382)	9,8 (.386)	BIT-T-912 M
T-112 302 130 300 250 A 1502 M	1,3 (.051)	3,0 (.118)	2,5 (.098)	36,0 (1.417)	10,7 (.421)	BIT-GKS-112 M
T-912 302 130 300 250 A 1502 M	1,3 (.051)	3,0 (.118)	2,5 (.098)	36,0 (1.417)	10,7 (.421)	BIT-T-912 M
T-912 302 140 160 350 A 3002 M	1,4 (.055)	1,6 (.063)	3,5 (.138)	34,6 (1.362)	9,3 (.366)	BIT-T-912 M
T-912 302 150 200 350 A 1502 M	1,5 (.059)	2,0 (.079)	3,5 (.138)	35,0 (1.378)	9,7 (.382)	BIT-T-912 M

Further versions available upon request

Part number	A Tip-Ø mm (inch)	B Tip length mm (inch)	C Disk-Ø mm (inch)	D Total length mm (inch)	E Install. height with KS mm (inch)	* Tool (insertion bit)
T-112 302 150 250 300 A 1502 M	1,5 (.059)	2,5 (.098)	3,0 (.118)	35,5 (1.398)	10,2 (.402)	BIT-GKS-112 M
T-912 302 150 250 350 A 1502 M	1,5 (.059)	2,5 (.098)	3,5 (.135)	35,5 (1.398)	10,2 (.402)	BIT-T-912 M
T-112 305 064 150 150 A 1502 M	0,64 (.024)	1,5 (.059)	1,5 (.059)	34,5 (1.358)	9,2 (.362)	BIT-GKS-112 M-B
T-112 305 064 250 150 A 1502 M	0,64 (.024)	2,5 (.098)	1,5 (.059)	35,5 (1.398)	10,2 (.402)	BIT-GKS-112 M-B
T-912 305 064 250 250 A 1502 M	0,64 (.024)	2,5 (.098)	2,5 (.098)	35,5 (1.398)	10,2 (.402)	BIT-T-912 M
T-112 305 064 300 150 A 1502 M	0,64 (.024)	3,0 (.118)	1,5 (.059)	36,0 (1.417)	10,7 (.421)	BIT-GKS-112 M-B
T-112 305 064 460 180 A 1502 M	0,64 (.024)	4,6 (.181)	1,8 (.071)	37,6 (1.480)	12,3 (.484)	BIT-GKS-112 M-B
T-112 305 065 200 180 A 3002 M	0,65 (.026)	2,0 (.079)	1,8 (.071)	35,0 (1.378)	9,7 (.382)	BIT-GKS-112 M-B
T-912 305 065 200 210 A 1502 M	0,65 (.026)	2,0 (.079)	2,1 (.083)	35 (1.378)	9,7 (.382)	BIT-T-912 M
T-912 305 065 230 250 A 1502 M	0,65 (.026)	2,3 (.091)	2,5 (.098)	35,3 (1.390)	10,0 (.394)	BIT-T-912 M
T-112 305 065 250 180 A 1502 M	0,65 (.026)	2,5 (.098)	1,8 (.071)	35,5 (1.398)	10,2 (.402)	BIT-GKS-112 M-B
T-912 305 065 250 210 A 1502 M	0,65 (.026)	2,5 (.098)	2,1 (.083)	35,5 (1.398)	10,2 (.402)	BIT-T-912 M
T-112 305 065 270 150 A 1502 M	0,65 (.026)	2,7 (.106)	1,5 (.059)	35,7 (1.406)	10,4 (.409)	BIT-GKS-112 M-B
T-112 305 065 270 150 A 1502 MG	0,65 (.026)	2,7 (.106)	1,5 (.059)	35,7 (1.406)	10,4 (.409)	BIT-GKS-112 M-B
T-912 305 065 300 210 A 1502 M	0,65 (.026)	3,0 (.118)	2,1 (.083)	36,0 (1.417)	10,7 (.421)	BIT-T-912 M
T-112 305 065 340 180 A 1502 M	0,65 (.026)	3,4 (.134)	1,8 (.071)	36,4 (1.433)	11,1 (.437)	BIT-GKS-112 M-B
T-112 305 065 340 210 A 1502 M	0,65 (.026)	3,4 (.134)	2,1 (.083)	36,4 (1.433)	11,1 (.437)	BIT-T-912 M
T-112 305 065 340 300 A 1502 M	0,65 (.026)	3,4 (.134)	3,0 (.118)	36,4 (1.433)	11,1 (.437)	BIT-GKS -112 M
T-912 305 065 340 300 A 1502 M	0,65 (.026)	3,4 (.134)	3,0 (.118)	36,4 (1.433)	11,1 (.437)	BIT-T-912 M
T-112 305 065 360 180 A 1502 M	0,65 (.026)	3,6 (.142)	1,8 (.071)	36,6 (1.457)	11,3 (.445)	BIT-GKS-112 M-B
T-912 305 065 360 210 A 1502 M	0,65 (.026)	3,6 (.142)	2,1 (.083)	36,6 (1.457)	11,3 (.445)	BIT-T-912 M
T-112 305 065 430 150 A 1502 M	0,65 (.026)	4,3 (.169)	1,5 (.059)	37,3 (1.479)	12,0 (.472)	BIT-GKS-112 M-B
T-112 305 065 500 150 A 1502 M	0,65 (.026)	5,0 (.197)	1,5 (.059)	38,0 (1.496)	12,7 (.500)	BIT-GKS-112 M-B
T-912 305 080 200 250 A 1502 M	0,8 (.032)	2,0 (.079)	2,5 (.098)	35,0 (1.378)	9,7 (.382)	BIT-T-912 M
T-912 305 080 230 250 A 1502 M	0,8 (.032)	2,3 (.091)	2,5 (.098)	35,3 (1.390)	10,0 (.394)	BIT-T-912 M
T-112 305 080 280 180 A 1502 M	0,8 (.032)	2,8 (.110)	1,8 (.071)	35,8 (1.409)	10,5 (.413)	BIT-GKS-112 M-B
T-112 305 080 280 195 A 1502 M	0,8 (.032)	2,8 (.110)	1,95 (.079)	35,8 (1.409)	10,5 (.413)	BIT-GKS-112 M-B
T-912 305 080 280 210 A 1502 M	0,8 (.032)	2,8 (.110)	2,1 (.083)	35,8 (1.409)	10,5 (.413)	BIT-T-912 M
T-112 305 080 280 250 A 1502 M	0,8 (.032)	2,8 (.110)	2,5 (.098)	35,8 (1.409)	10,5 (.413)	BIT-GKS-112 M
T-912 305 080 280 250 A 1502 M	0,8 (.032)	2,8 (.110)	2,5 (.098)	35,8 (1.409)	10,5 (.413)	BIT-T-912 M
T-112 305 080 320 230 A 1502 M	0,8 (.032)	3,2 (.126)	2,3 (.091)	36,2 (1.425)	10,9 (.429)	BIT-GKS-112 M
T-912 305 080 320 230 A 1502 M	0,8 (.032)	3,2 (.126)	2,3 (.091)	36,2 (1.425)	10,9 (.429)	BIT-T-912 M
T-112 305 080 320 350 A 1502 M	0,8 (.032)	3,2 (.126)	3,5 (.138)	36,2 (1.425)	10,9 (.429)	BIT-GKS-112 M
T-912 305 080 320 350 A 1502 M	0,8 (.032)	3,2 (.126)	3,5 (.138)	36,2 (1.425)	10,9 (.429)	BIT-T-912 M
T-112 305 080 400 180 A 1502 M	0,8 (.032)	4,0 (.158)	1,8 (.071)	37,0 (1.457)	11,7 (.461)	BIT-GKS-112 M-B
T-912 305 080 400 210 A 1502 M	0,8 (.032)	4,0 (.158)	2,1 (.083)	37,0 (1.457)	11,7 (.461)	BIT-T-912 M
T-112 305 080 400 250 A 1502 M	0,8 (.032)	4,0 (.158)	2,5 (.098)	37,0 (1.457)	11,7 (.461)	BIT-GKS-112 M
T-912 305 080 400 250 A 1502 M	0,8 (.032)	4,0 (.158)	2,5 (.098)	37,0 (1.457)	11,7 (.461)	BIT-T-912 M
T-112 305 080 460 250 A 1502 M	0,8 (.032)	4,6 (.181)	2,5 (.098)	37,6 (1.480)	12,3 (.484)	BIT-GKS-112 M
T-912 305 080 460 250 A 1502 M	0,8 (.032)	4,6 (.181)	2,5 (.098)	37,6 (1.480)	12,3 (.484)	BIT-T-912 M
T-912 305 080 530 280 A 1502 M	0,8 (.032)	5,3 (.209)	2,8 (.110)	38,3 (1.508)	13,0 (.512)	BIT-T-912 M
T-112 305 100 200 180 A 1502 M	1,0 (.039)	2,0 (.079)	1,8 (.071)	35,0 (1.378)	9,7 (.382)	BIT-GKS-112 M-B
T-912 305 100 200 210 A 1502 M	1,0 (.039)	2,0 (.079)	2,1 (.083)	35,0 (1.378)	9,7 (.382)	BIT-T-912 M
T-912 305 100 250 300 A 1502 M	1,0 (.039)	2,5 (.098)	3,0 (.118)	35,5 (1.398)	10,2 (.402)	BIT-T-912 M
T-912 305 100 260 210 A 1502 M	1,0 (.039)	2,6 (.102)	2,1 (.083)	35,6 (1.402)	10,3 (.406)	BIT-T-912 M
T-912 305 100 260 230 A 1502 M	1,0 (.039)	2,6 (.102)	2,3 (.091)	35,6 (1.402)	10,3 (.406)	BIT-T-912 M
T-112 305 100 260 250 A 1502 M	1,0 (.039)	2,6 (.102)	2,5 (.098)	35,6 (1.402)	10,3 (.406)	BIT-GKS-112 M
T-912 305 100 260 250 A 1502 M	1,0 (.039)	2,6 (.102)	2,5 (.098)	35,6 (1.402)	10,3 (.406)	BIT-T-912 M
T-912 305 100 350 250 A 1502 M	1,0 (.039)	3,5 (.138)	2,5 (.098)	36,5 (1.402)	11,2 (.441)	BIT-T-912 M
T-112 305 100 420 180 A 1502 M	1,0 (.039)	4,2 (.165)	1,8 (.071)	37,2 (1.465)	11,9 (.496)	BIT-GKS-112 M-B
T-912 305 100 420 210 A 1502 M	1,0 (.039)	4,2 (.165)	2,1 (.083)	37,2 (1.465)	11,9 (.496)	BIT-T-912 M
T-112 305 100 490 180 A 1502 M	1,0 (.039)	4,9 (.193)	1,8 (.071)	37,9 (1.492)	12,6 (.496)	BIT-GKS-112 M-B
T-912 305 100 490 210 A 1502 M	1,0 (.039)	4,9 (.193)	2,1 (.083)	37,9 (1.492)	12,6 (.496)	BIT-T-912 M
T-912 305 100 600 250 A 1502 M	1,0 (.039)	6,0 (.236)	2,5 (.098)	39,0 (1.535)	13,7 (.539)	BIT-T-912 M
T-912 305 120 220 250 A 3002 M	1,2 (.047)	2,2 (.087)	2,5 (.098)	35,2 (1.386)	9,9 (.390)	BIT-T-912 M
T-912 305 120 250 250A 1502 M	1,2 (.047)	2,5 (.098)	2,5 (.098)	35,5 (1.398)	10,2 (.402)	BIT-T-912 M
T-912 305 140 160 320 A 1502 M	1,4 (.055)	1,6 (.063)	3,2 (.126)	34,6 (1.362)	9,3 (.366)	BIT-T-912 M
T-912 305 140 350 250 A 3002 M	1,4 (.055)	3,5 (.138)	2,5 (.098)	36,5 (1.437)	11,2 (.441)	BIT-T-912 M
T-912 305 140 350 280 A 3002 M	1,4 (.055)	3,5 (.138)	2,8 (.110)	36,5 (1.437)	11,2 (.441)	BIT-T-912 M
T-912 305 150 250 300 A 1502 M	1,5 (.059)	2,5 (.098)	3,0 (.118)	35,5 (1.398)	10,2 (.402)	BIT-T-912 M

T-113 M / T-888 M

Screw-in Step Probes

Grid:

≥ 4,00 mm (dependent on max. tip diameter)

≥ 160 Mil (dependent on max. tip diameter)

Installation height with KS: see table

Recommended stroke: 4,0 mm (.157)

Mounting and functional dimensions

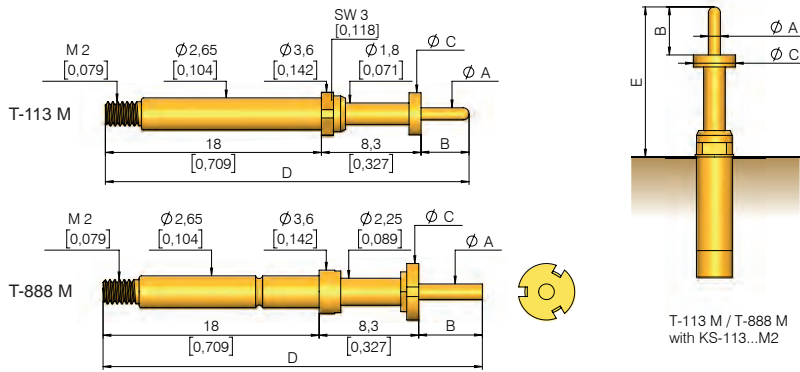

Mechanical data

Working stroke: 4,0 mm (.158)
Maximum stroke: 5,0 mm (.197)
Spring forces at work. str.: 1,5 N (5,4oz)
altern. T-113 M: 0,3 N (1.1oz); 0,6 N (2.2oz); 1,0 N (3.6 oz); 2,25 N (8.1oz); 3,0 N (10.8oz); 5,0 N (18.1oz)
altern. T-888 M: 3,0 N (10.8oz)

Materials

Plunger: BeCu, gold-plated
Barrel: Brass, gold-plated
Spring: Steel, gold-plated or stainless steel (MC on request)

Note:

The T-113 M / T-888 M is screwed into KS-113 M, see page 128.

Electrical data

Current rating: 5 - 8 A
R_i typical: < 30 mΩ

Operating temperature

Standard: -40° up to +80° C

Recommended screw-in torque:***
 Min.: 10 cNm / Max.: 20 cNm

Available tip style T-113 M

Material	Tip style	Plating	Further versions	
			Ø	Ø (inch)
3 02		A	Ø s. tbl.	
3 05		A	Ø s. tbl.	

Available tip style T-888 M

Material	Tip style	Plating	Further versions	
			Ø	Ø (inch)
3 02*		A	Ø s. tbl.	
3 02**		A	Ø s. tbl.	
3 05		A	Ø s. tbl.	

* Ø A ≤ 2,5 mm

** Ø A ≥ 3,5 mm (screw-in only with tool BIT-T-912 M)

*** See table below

Part number	A Tip-Ø mm (inch)	B Tip length mm (inch)	C Disk-Ø mm (inch)	D Total length mm (inch)	E Install. height with KS mm (inch)	*** Tool (insertion bit)
T-113 302 100 300 350 A 1502 M	1,0 (.039)	3,0 (.118)	3,5 (.138)	29,3 (1.154)	11,5 (.453)	BIT-GKS-113 M
T-888 302 100 300 350 A 1502 M	1,0 (.039)	3,0 (.118)	3,5 (.138)	29,3 (1.154)	11,5 (.453)	BIT-T-888 M-3
T-113 302 130 270 470 A 1502 M	1,3 (.051)	2,7 (.106)	4,7 (.185)	29,0 (1.142)	11,2 (.441)	BIT-T-113 M
T-888 302 130 270 470 A 1502 M	1,3 (.051)	2,7 (.106)	4,7 (.185)	29,0 (1.142)	11,2 (.441)	BIT-T-888 M
T-888 302 130 300 470 A 1502 M	1,3 (.051)	3,0 (.118)	4,7 (.185)	29,3 (1.154)	11,5 (.453)	BIT-T-888 M
T-113 302 130 360 470 A 1502 M	1,3 (.051)	3,6 (.142)	4,7 (.185)	29,9 (1.177)	12,1 (.476)	BIT-T-113 M
T-888 302 130 360 470 A 1502 M	1,3 (.051)	3,6 (.142)	4,7 (.185)	29,9 (1.177)	12,1 (.476)	BIT-T-888 M
T-113 302 130 530 470 A 1502 M	1,3 (.051)	5,3 (.209)	4,7 (.185)	31,6 (1.244)	13,8 (.543)	BIT-T-113 M
T-888 302 130 530 470 A 1502 M	1,3 (.051)	5,3 (.209)	4,7 (.185)	31,5 (1.240)	13,7 (.539)	BIT-T-888 M
T-113 302 130 580 470 A 1502 M	1,3 (.051)	5,8 (.228)	4,7 (.185)	32,1 (1.264)	14,3 (.563)	BIT-T-113 M
T-888 302 130 580 470 A 1502 M	1,3 (.051)	5,8 (.228)	4,7 (.185)	32,0 (1.260)	14,2 (.559)	BIT-T-888 M
T-113 302 140 100 350 A 1502 M	1,4 (.055)	1,0 (.039)	3,5 (.138)	27,3 (1.074)	9,5 (.374)	BIT-GKS-113 M
T-888 302 140 100 350 A 1502 M	1,4 (.055)	1,0 (.039)	3,5 (.138)	27,3 (1.074)	9,5 (.374)	BIT-T-888 M
T-113 302 140 170 350 A 1502 M	1,4 (.055)	1,7 (.067)	3,5 (.138)	28,0 (1.102)	10,2 (.402)	BIT-GKS-113 M
T-888 302 140 170 350 A 1502 M	1,4 (.055)	1,7 (.067)	3,5 (.138)	28,0 (1.102)	10,2 (.402)	BIT-T-888 M
T-113 302 140 200 350 A 1502 M	1,4 (.055)	2,0 (.079)	3,5 (.138)	28,3 (1.114)	10,5 (.413)	BIT-GKS-113 M
T-888 302 140 200 350 A 1502 M	1,4 (.055)	2,0 (.079)	3,5 (.138)	28,3 (1.114)	10,5 (.413)	BIT-T-888 M-3
T-113 302 140 240 350 A 1502 M	1,4 (.055)	2,4 (.095)	3,5 (.138)	28,7 (1.130)	10,9 (.429)	BIT-GKS-113 M
T-888 302 140 240 350 A 1502 M	1,4 (.055)	2,4 (.095)	3,5 (.138)	28,7 (1.130)	10,9 (.429)	BIT-T-888 M
T-113 302 140 300 350 A 1502 M	1,4 (.055)	3,0 (.118)	3,5 (.138)	29,3 (1.154)	11,5 (.453)	BIT-GKS-113 M
T-888 302 140 300 350 A 1502 M	1,4 (.055)	3,0 (.118)	3,5 (.138)	29,3 (1.154)	11,5 (.453)	BIT-T-888 M
T-113 302 140 320 250 A 1502 M	1,4 (.055)	3,2 (.126)	2,5 (.098)	29,5 (1.161)	11,7 (.461)	BIT-GKS-113 M-B
T-113 302 170 220 300 A 1502 M	1,7 (.067)	2,2 (.087)	3,0 (.118)	28,5 (1.122)	10,7 (.421)	BIT-GKS-113 M-B
T-113 302 170 220 350 A 1502 M	1,7 (.067)	2,2 (.087)	3,5 (.138)	28,5 (1.122)	10,7 (.421)	BIT-GKS-113 M
T-888 302 170 220 350 A 1502 M	1,7 (.067)	2,2 (.087)	3,5 (.138)	28,5 (1.122)	10,7 (.421)	BIT-T-888 M
T-888 302 180 140 450 A 1502 M	1,8 (.071)	1,4 (.055)	4,5 (.177)	27,7 (1.091)	9,9 (.390)	BIT-T-888 M
T-113 302 180 150 450 A 1502 M	1,8 (.071)	1,5 (.059)	4,5 (.177)	27,8 (1.095)	10,0 (.394)	BIT-T-113 M
T-888 302 180 150 450 A 1502 M	1,8 (.071)	1,5 (.059)	4,5 (.177)	27,8 (1.095)	10,0 (.394)	BIT-T-888 M
T-113 302 180 160 350 A 1502 M	1,8 (.071)	1,6 (.063)	3,5 (.138)	27,9 (1.098)	10,1 (.398)	BIT-GKS-113 M
T-888 302 180 160 350 A 1502 M	1,8 (.071)	1,6 (.063)	3,5 (.138)	27,9 (1.098)	10,1 (.398)	BIT-T-888 M-3
T-888 302 180 200 470 A 1502 M	1,8 (.071)	2,0 (.079)	4,7 (.185)	28,3 (1.114)	10,5 (.413)	BIT-T-888 M
T-888 302 180 220 350 A 1502 M	1,8 (.071)	2,2 (.087)	3,5 (.138)	28,5 (1.122)	10,7 (.421)	BIT-T-888 M-3

Part number	A Tip-Ø mm (inch)	B Tip length mm (inch)	C Disk-Ø mm (inch)	D Total length mm (inch)	E Install. height with KS mm (inch)	*** Tool (insertion bit)
T-888 302 180 420 470 A 1502 M	1,8 (.071)	4,2 (.165)	4,7 (.185)	30,5 (1.201)	12,7 (.500)	BIT-T-888 M
T-888 302 180 500 470 A 1502 M	1,8 (.071)	5,0 (.197)	4,7 (.185)	31,3 (1.232)	13,5 (.532)	BIT-T-888 M
T-113 302 180 580 470 A 1502 M	1,8 (.071)	5,8 (.228)	4,7 (.185)	32,1 (1.264)	14,3 (.563)	BIT-T-113 M
T-888 302 180 580 470 A 1502 M	1,8 (.071)	5,8 (.228)	4,7 (.185)	32,1 (1.264)	14,3 (.563)	BIT-T-888 M
T-888 302 220 180 350 A 1502 M	2,2 (.087)	1,8 (.071)	3,5 (.138)	28,1 (1.106)	10,3 (.406)	BIT-T-888 M-3
T-888 302 220 200 350 A 1502 M	2,2 (.087)	2,0 (.079)	3,5 (.138)	28,3 (1.114)	10,5 (.413)	BIT-T-888 M-3
T-113 302 230 180 350 A 1502 M	2,3 (.091)	1,8 (.071)	3,5 (.138)	28,1 (1.106)	10,3 (.406)	BIT-GKS-113 M
T-113 302 230 200 350 A 1502 M	2,3 (.091)	2,0 (.079)	3,5 (.138)	28,3 (1.114)	10,5 (.413)	BIT-GKS-113 M
T-888 302 250 120 470 A 1502 M	2,5 (.098)	1,2 (.048)	4,7 (.185)	27,5 (1.083)	9,7 (.382)	BIT-T-888 M
T-888 302 250 200 470 A 1502 M	2,5 (.098)	2,0 (.079)	4,7 (.185)	28,3 (1.114)	10,5 (.413)	BIT-T-888 M
T-888 302 250 220 470 A 1502 M	2,5 (.098)	2,2 (.087)	4,7 (.185)	28,5 (1.122)	10,7 (.421)	BIT-T-888 M
T-888 302 250 300 470 A 1502 M	2,5 (.098)	3,0 (.118)	4,7 (.185)	29,3 (1.154)	11,5 (.453)	BIT-T-888 M
T-888 302 370 350 500 A 1502 M	3,7 (.146)	3,5 (.138)	5,0 (.197)	29,8 (1.173)	12,0 (.472)	BIT-T-912 M
T-888 302 370 550 500 A 1502 M	3,7 (.146)	5,5 (.217)	5,0 (.197)	31,8 (1.252)	14,0 (.551)	BIT-T-912 M
T-888 302 400 100 500 A 1502 M	4,0 (.158)	1,0 (.039)	5,0 (.197)	27,3 (1.075)	9,5 (.374)	BIT-T-912 M
T-888 302 400 130 500 A 1502 M	4,0 (.158)	1,3 (.051)	5,0 (.197)	27,6 (1.087)	9,8 (.386)	BIT-T-912 M
T-888 302 400 170 500 A 1502 M	4,0 (.158)	1,7 (.067)	5,0 (.197)	28,0 (1.102)	10,2 (.402)	BIT-T-912 M
T-113 302 400 200 500 A 1502 M	4,0 (.158)	2,0 (.079)	5,0 (.197)	28,3 (1.114)	10,5 (.413)	BIT-T-113 M
T-888 302 400 200 500 A 1502 M	4,0 (.158)	2,0 (.079)	5,0 (.197)	28,3 (1.114)	10,5 (.413)	BIT-T-912 M
T-113 305 080 150 300 A 1502 M	0,8 (.032)	1,5 (.059)	3,0 (.118)	27,8 (1.095)	10,0 (.394)	BIT-GKS-113 M-B
T-888 305 080 150 300 A 1502 M	0,8 (.032)	1,5 (.059)	3,0 (.118)	27,8 (1.095)	10,0 (.394)	BIT-T-888 M-3
T-113 305 080 250 300 A 1502 M	0,8 (.032)	2,5 (.098)	3,0 (.118)	28,8 (1.134)	11,0 (.433)	BIT-GKS-113 M-B
T-888 305 080 250 300 A 1502 M	0,8 (.032)	2,5 (.098)	3,0 (.118)	28,8 (1.134)	11,0 (.433)	BIT-T-888 M-3
T-113 305 080 280 300 A 1502 M	0,8 (.032)	2,8 (.110)	3,0 (.118)	29,1 (1.146)	11,3 (.445)	BIT-GKS-113 M-B
T-888 305 080 280 300 A 1502 M	0,8 (.032)	2,8 (.110)	3,0 (.118)	29,1 (1.146)	11,3 (.445)	BIT-T-888 M-3
T-113 305 080 300 300 A 1502 M	0,8 (.032)	3,0 (.118)	3,0 (.118)	29,3 (1.154)	11,5 (.445)	BIT-GKS-113 M-B
T-888 305 080 300 300 A 1502 M	0,8 (.032)	3,0 (.118)	3,0 (.118)	29,3 (1.154)	11,5 (.445)	BIT-T-888 M-3
T-113 305 100 280 350 A 1502 M	1,0 (.039)	2,8 (.110)	3,5 (.138)	29,1 (1.146)	11,3 (.445)	BIT-GKS-113 M
T-888 305 100 280 350 A 1502 M	1,0 (.039)	2,8 (.110)	3,5 (.138)	29,1 (1.146)	11,3 (.445)	BIT-T-888 M-3
T-113 305 100 400 350 A 1502 M	1,0 (.039)	4,0 (.158)	3,5 (.138)	30,3 (1.193)	12,5 (.492)	BIT-GKS-113 M
T-888 305 100 400 350 A 1502 M	1,0 (.039)	4,0 (.158)	3,5 (.138)	30,3 (1.193)	12,5 (.492)	BIT-T-888 M-3
T-113 305 140 100 350 A 1502 M	1,4 (.055)	1,0 (.039)	3,5 (.138)	27,3 (1.075)	9,5 (.374)	BIT-GKS-113 M
T-888 305 140 100 350 A 1502 M	1,4 (.055)	1,0 (.039)	3,5 (.138)	27,3 (1.075)	9,5 (.374)	BIT-T-888 M-3
T-113 305 140 170 320 A 1502 M	1,4 (.055)	1,7 (.067)	3,2 (.126)	28,0 (1.102)	10,2 (.402)	BIT-GKS-113 M
T-888 305 140 170 320 A 1502 M	1,4 (.055)	1,7 (.067)	3,2 (.126)	28,0 (1.102)	10,2 (.402)	BIT-T-888 M-3
T-888 305 140 200 350 A 1502 M	1,4 (.055)	2,0 (.079)	3,5 (.138)	28,3 (1.114)	10,5 (.413)	BIT-T-888 M-3
T-113 305 140 240 350 A 1502 M	1,4 (.055)	2,4 (.095)	3,5 (.138)	28,7 (1.130)	10,9 (.429)	BIT-GKS-113 M
T-888 305 140 240 350 A 1502 M	1,4 (.055)	2,4 (.095)	3,5 (.138)	28,7 (1.130)	10,9 (.429)	BIT-T-888 M-3
T-888 305 140 270 350 A 1502 M	1,4 (.055)	2,7 (.106)	3,5 (.138)	29,0 (1.142)	11,2 (.441)	BIT-T-888 M-3
T-113 305 140 320 350 A 1502 M	1,4 (.055)	3,2 (.126)	3,5 (.138)	29,5 (1.161)	10,7 (.421)	BIT-GKS-113 M
T-888 305 140 320 350 A 1502 M	1,4 (.055)	3,2 (.126)	3,5 (.138)	29,5 (1.161)	11,7 (.461)	BIT-T-888 M-3
T-113 305 140 330 350 A 1502 M	1,4 (.055)	3,3 (.130)	3,5 (.138)	29,6 (1.165)	11,8 (.465)	BIT-GKS-113 M
T-888 305 140 330 350 A 1502 M	1,4 (.055)	3,3 (.130)	3,5 (.138)	29,6 (1.165)	11,8 (.465)	BIT-T-888 M-3
T-113 305 140 400 350 A 1502 M	1,4 (.055)	4,0 (.158)	3,5 (.138)	30,3 (1.193)	12,5 (.492)	BIT-GKS-113 M
T-888 305 140 400 350 A 1502 M	1,4 (.055)	4,0 (.158)	3,5 (.138)	30,3 (1.193)	12,5 (.492)	BIT-T-888 M-3
T-113 305 150 400 350 A 1502 M	1,5 (.059)	4,0 (.158)	3,5 (.138)	30,3 (1.193)	12,5 (.492)	BIT-GKS-113 M
T-888 305 150 400 350 A 1502 M	1,5 (.059)	4,0 (.158)	3,5 (.138)	30,3 (1.193)	12,5 (.492)	BIT-T-888 M-3
T-113 305 170 220 330 A 1502 M	1,7 (.067)	2,2 (.087)	3,3 (.130)	28,5 (1.120)	10,7 (.421)	BIT-GKS-113 M
T-888 305 170 220 330 A 1502 M	1,7 (.067)	2,2 (.087)	3,3 (.130)	28,5 (1.120)	10,7 (.421)	BIT-T-888 M-3
T-113 305 180 140 400 A 1502 M	1,8 (.071)	1,4 (.055)	4,0 (.158)	27,7 (1.091)	9,9 (.390)	BIT-GKS-113 M
T-888 305 180 140 400 A 1502 M	1,8 (.071)	1,4 (.055)	4,0 (.158)	27,7 (1.091)	9,9 (.390)	BIT-T-888 M-3
T-113 305 180 300 400 A 1502 M	1,8 (.071)	3,0 (.118)	4,0 (.158)	29,3 (1.154)	11,5 (.453)	BIT-GKS-113 M
T-888 305 180 300 400 A 1502 M	1,8 (.071)	3,0 (.118)	4,0 (.158)	29,3 (1.154)	11,5 (.453)	BIT-T-888 M-3

T-785 M

Innovative Contacting of Clips and Jacks Using Splayed Tip

NEW

Grid:
 ≥ 4,50 mm
 ≥ 177 Mil

Installation height with KS: 14,3 / 15,3 mm (.768 / .984)
 Recommended stroke: 12,0 mm (.472)

Mounting and functional dimensions



T-785 367 200 700 400 A 9902 M
 (Opening 2,1 to 2,4 mm)

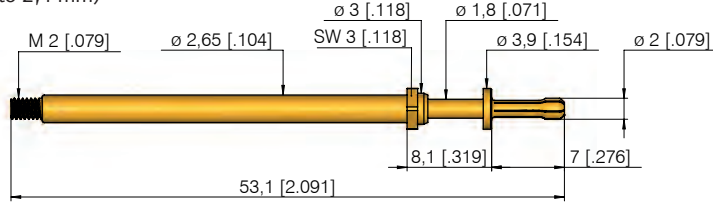

T-785 367 260 600 400 A 9902 M
 (Opening 2,7 to 3,0 mm)

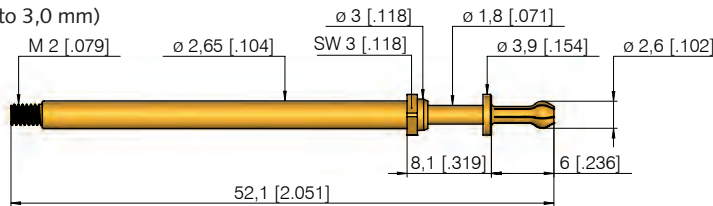

T-785 367 300 600 500 A 9902 M
 (Opening 3,1 to 3,4 mm)

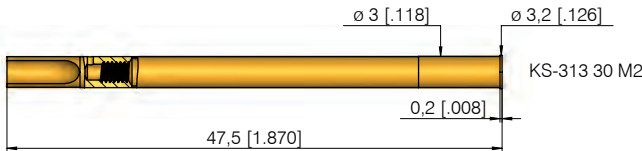
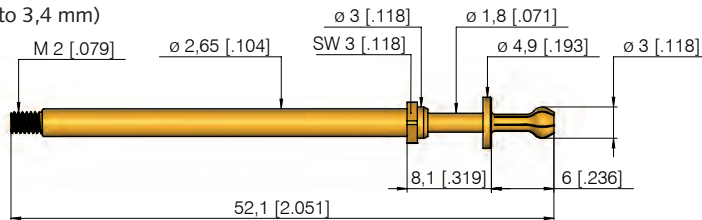

Available tip style

Material	Tip style	Plating	Further versions	
			∅	∅ (inch)
3 67		A	2,60	(.102)
3 67		A		

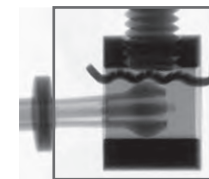

Example: Contacting of a print clip with T-785 M

Note:

The wear-free contacting is achieved via the outer wall of the contacting cage and the splayed tip. The splayed tip opens as soon as the collar of the probe rests against the casing of the clip. Different versions are available for round and square cross-sections, depending on the shape of the opening to be contacted.

Note:

T-785 ... M is screwed into KS-313 30 M2.

Recommended screw-in torque:
 Min.: 10 cNm / Max.: 20 cNm

Mechanical data

Working stroke: 4,0 mm (.157)
 Maximum stroke: 5,3 mm (.209)
 Spring force at work. stroke: 10 N (35.9oz)

Materials

Plunger: BeCu, gold-plated
 Barrel: Brass, gold-plated
 Spring: Steel, gold-plated
 Receptacle: Brass, gold-plated

Electrical data

Current rating: 16 A
 R_i typical: < 20 mΩ

Mounting hole size

in CEM1 and FR4: ∅ 2,99 mm (.1177)

Operating temperature

Standard: -40° up to +80° C

To contacting clamp

Min. opening depth 6,5 mm (.256)

Ordering example

Test probe (opening 2,1 to 2,4 mm):

T 7 8 5 3 6 7 2 0 0 7 0 0 4 0 0 A 9 9 0 2 M

Test probe (opening 2,7 to 3,0 mm):

T 7 8 5 3 6 7 2 6 0 6 0 0 4 0 0 A 9 9 0 2 M

Test probe (opening 3,1 to 3,4 mm):

T 7 8 5 3 6 7 3 0 0 6 0 0 5 0 0 A 9 9 0 2 M

Receptacle:

K S - 3 1 3 3 0 M 2

Push-back Test Probes

Non-rotating Test Probes

When finally plugging the plug connectors together, it is important that the contact terminals (contact sheets) remain in the correct position and cannot be pushed back. For this test, **push-back probes** with a spring force of up to 34 N are used.

Push-back probes are usually installed in test modules in cable test benches. The probes are designed with a continuous plunger. During the test, the push-back probe is pressed against the contact sheet. If the contact sheet stays in the correct position, the plunger makes a downwards stroke movement. This achieves contact with the test probe or switching probe which is installed below which can, in turn, confirm the correct position of the contact sheet.

In combination with switching probes featuring plastic tip styles, voltage-free tests are possible.

For testing flat connector blades or jacks which can only be contacted in one position, **non-rotating probes** are used. Only this enables tests be performed without damaging the plug connector components. During assembly, these probes are mounted in the correct position. Non-rotating test probes are designed to have forcibly-guided plungers, which make rotation impossible.

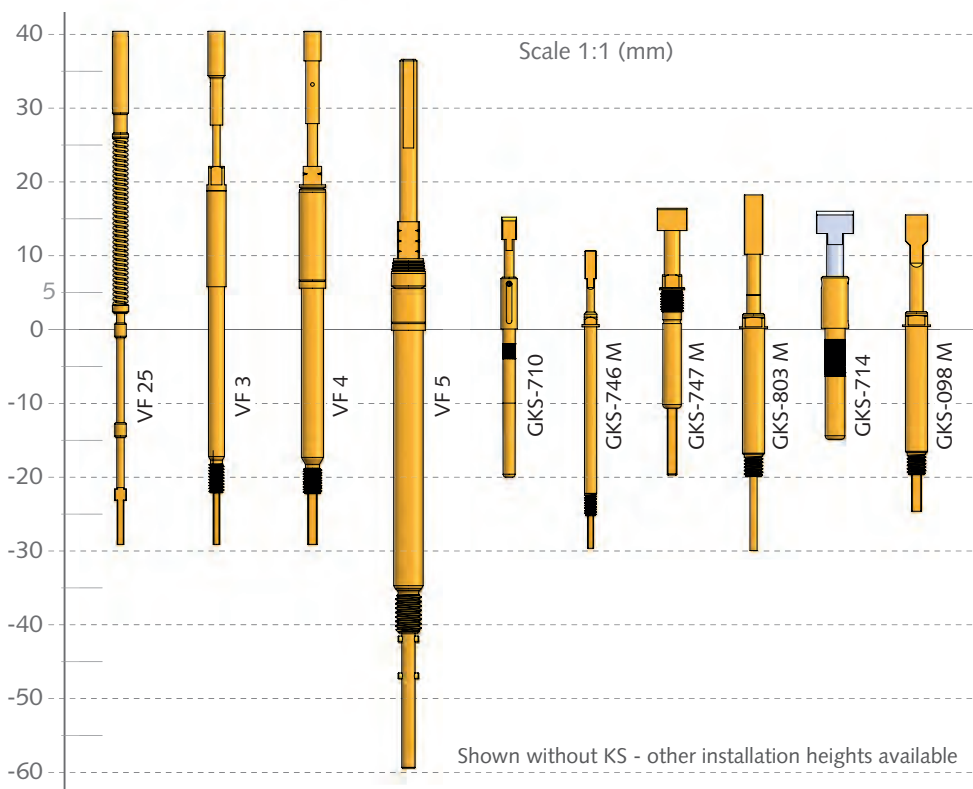

Push-back Probes

VF 25	142
VF 3	143
VF 4	144
VF 5	145

Non-rotating Probes

GKS-710	146
GKS-746 M	147
GKS-747 M	148
GKS-803 M	149
GKS-714	150
GKS-098	150
GKS-098 M	151
VK-541 NEW	93
HKF-617 NEW	94
KK-541 NEW	95

Note:

See page 118 for overview and comparison table.

VF 25

Push-back Probe

Grid:

≥ 2,54 mm

≥ 100 Mil

Installation height with KS: 40,5 mm (1.594)

Recommended stroke: 5,0 mm (.197)

Mounting and functional dimensions

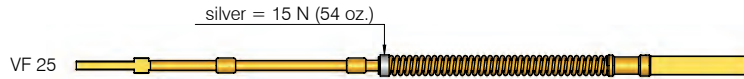
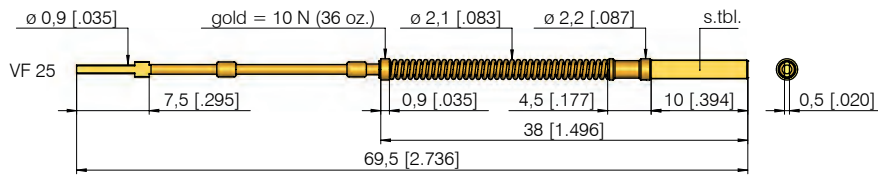

KS-VF 25
also available pre-wired with wire
AWG 34 (0,2m): KS-VF 25 V, minimal
recommended bending radius: 10 mm (.394)

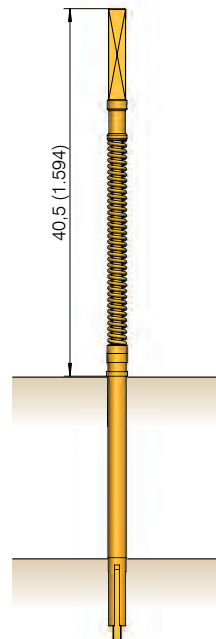
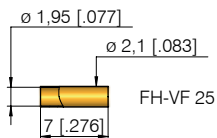

Available tip styles

Material	Tip style	Plating	Further versions	
			∅	∅ (inch)
2	03	∅ 2,20 (.087)	A	
2	29 *	258	A	
2	29 *	193	A	

Installation height
Installation height: 40,5 mm (1.594)

Mechanical data
Working stroke: 5,0 mm (.197)
Maximum stroke: 6,0 mm (.236)
Spring force at work. stroke: 10 N (36oz); 15 N (54oz)
Interchangeable stroke: > 6,0 mm (.236)

Electrical data
Current rating: 5 A
R_j typical: < 50 mΩ

Operating temperature
Standard: -40° up to +80° C

Materials
Plunger: Steel, gold-plated
Spring: Steel, gold-plated
Receptacle: Bronze, gold-plated

Mounting hole size
in CEM1 and FR4: ∅ 2,00 mm (.0787)

Note:*

The flat surface on the plunger tip is aligned with the flat surface on the rear of the plunger.

Assembly Notice:**

The patented design allows the test probe (consisting of plunger and spring) to be easily exchanged when necessary, as follows:

- press the plunger into the receptacle until it reaches its limit
- turn the plunger 90°
- release the plunger

In order to stabilise the test probe and to avoid damage to the receptacle during mounting and dismounting, we recommend that either an additional guide plate be inserted underneath, or that the guide bush FH-VF 25 be attached to the end of the receptacle after mounting, and subsequently soldered to secure it.

Ordering example

	Series	Tip material 2 = Steel	Tip style	Tip Diameter (1/100 mm) (spade width)	Plating A = Gold	Spring force (N)
Test probe:	V F 2 5	2	2 9	1 9 3	A	1 5 0
Receptacle:	K S - V F 2 5					
Receptacle (pre-wired with 0,2 m wire AWG 34):	K S - V F 2 5 V					
Guide bush:**	F H - V F 2 5					

Grid:
 ≥ 3,00 mm
 ≥ 120 Mil

Install. height with KS: 40,5/44,5/46,5 mm (1.595/1.752/1.831)
Recommended stroke: 5,0 mm (.197)

Mounting and functional dimensions

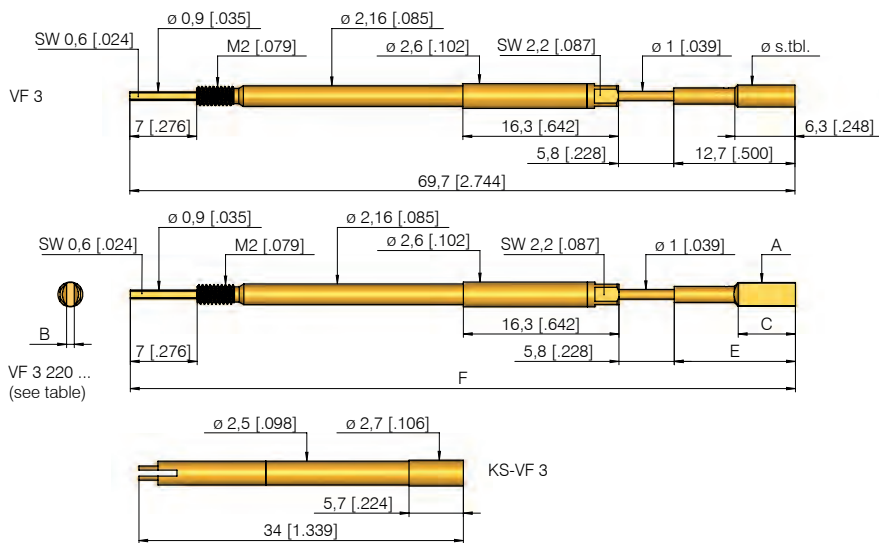

Material		Tip style	Plating	Further versions	
				∅	∅ (inch)
2	02		A	1,50 1,80 3,00	(.059) (.071) (.118)
	03		A	2,20 3,00	(.087) (.118)
2	05		A	1,70	(.067)
2	06		A	2,70 3,00	(.106) (.118)
2	20*		A		

Part No.	A Tip-∅ mm (inch)	B Width of spade in mm (inch)	C Length of spade in mm (inch)	D Installation height with KS in mm (inch)	E Tip height in mm (inch)	F Total length mm (inch)
VF3 220 250 080 A 405 xx	2,5 (.098)	0,8 (.031)	6,0 (.236)	40,5 (1.594)	12,7 (.500)	69,7 (2.744)
VF3 220 250 050 A 405 xx	2,5 (.098)	0,5 (.020)	6,0 (.236)	40,5 (1.594)	12,7 (.500)	69,7 (2.744)
VF3 220 250 150 A 405 xx	2,5 (.098)	1,5 (.059)	6,0 (.236)	40,5 (1.594)	12,7 (.500)	69,7 (2.744)
VF3 220 190 050 A 405 xx	1,9 (.075)	0,5 (.020)	6,0 (.236)	40,5 (1.594)	12,7 (.500)	69,7 (2.744)
VF3 220 190 050 A 465 xx	1,9 (.075)	0,5 (.020)	12,0 (.472)	46,5 (1.831)	18,7 (.736)	75,7 (2.980)
VF3 220 190 080 A 405 xx	1,9 (.075)	0,8 (.031)	6,0 (.236)	40,5 (1.594)	12,7 (.500)	69,7 (2.744)
VF3 220 400 060 A 445 xx	4,0 (.160)	0,6 (.024)	10,0 (.394)	44,5 (1.752)	16,7 (.657)	73,7 (2.902)
VF3 220 220 120 A 405 xx	2,2 (.087)	1,2 (.047)	6,0 (.236)	40,5 (1.594)	12,7 (.500)	69,7 (2.744)
VF3 220 270 080 A 405 xx	2,7 (.106)	0,8 (.031)	6,0 (.236)	40,5 (1.594)	12,7 (.500)	69,7 (2.744)
VF3 220 250 080 A 465 xx	2,5 (.098)	0,8 (.031)	12,0 (.472)	46,5 (1.831)	18,7 (.736)	75,7 (2.980)

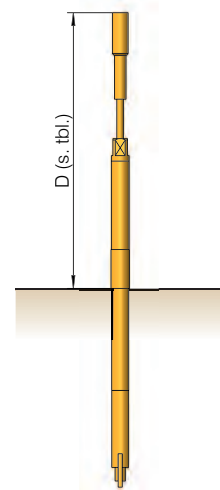

Installation height
 Installation height with KS: see table

Note:*
 The flat surface on the plunger tip is aligned with the flat surface on the rear of the plunger.

Recommended screw-in torque:
 Min.: 3 cNm / Max.: 5 cNm

Mechanical data

Working stroke: 5,0 mm (.197)
Maximum stroke: 5,5 mm (.217)
Spring force at work. stroke: 5,0 N (18oz); 10,0 N (34.6oz); 15,0 N (54oz)

Materials

Plunger: Steel, gold-plated
Barrel: Brass, gold-plated
Spring: Steel, gold-plated
Receptacle: Brass, gold-plated

Electrical data

Current rating: 8 A
R_i typical: < 30 mΩ

Mounting hole size

in CEM1 and FR4: ∅ 2,5 mm (.098)

Operating temperature

Standard: -40° up to +80° C

Ordering example

Series	Tip material	Tip style	Tip diameter (A) (1/100 mm)	Spade width (B) (1/100 mm)	Plating	Installation height (D) (1/10 mm)	Spring force (N)
--------	--------------	-----------	-----------------------------	----------------------------	---------	-----------------------------------	------------------

Test probe with tip style 220:

V F 3 2 2 0 2 5 0 0 8 0 A 4 0 5 0 5

Test probe:

V F 3 2 0 2 2 3 0 A 1 5

Receptacle:

K S - V F 3

VF 4

Push-back Probe

Grid:

≥ 4,00 mm

≥ 157 Mil

Installation height with KS: 40,5 / 46,5 mm (1.594 / .1.831)

Recommended stroke: 5,0 mm (.197)

Mounting and functional dimensions

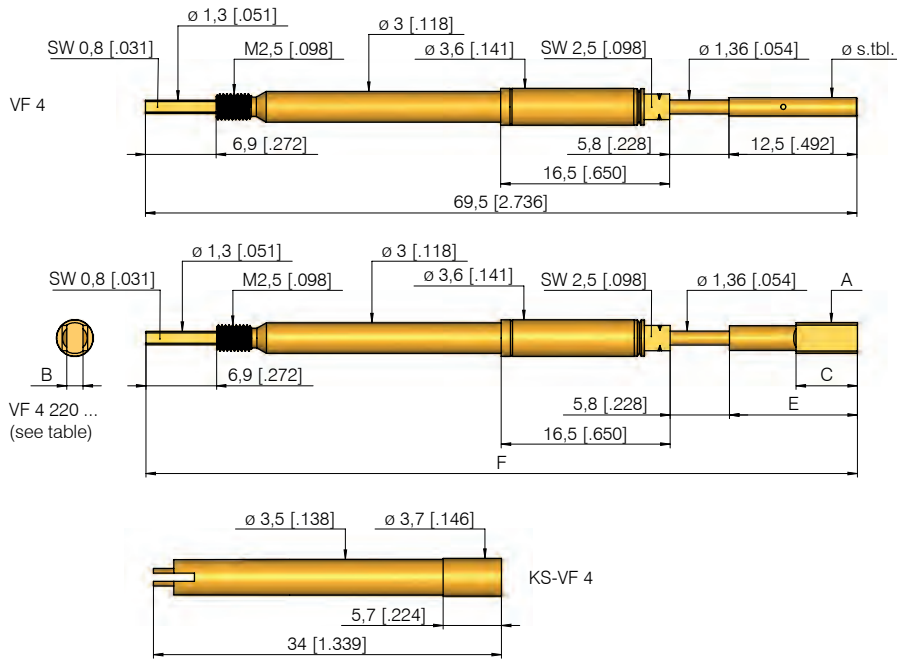

Available tip styles

Material	Tip style	Plating	Further versions	
			\varnothing	\varnothing (inch)
2 02		A	2,00	(.079)
2 02		A		
2 03		A	4,00	(.157)
2 06		A	4,00	(.157)
2 20*		A		
2 21*		A	0,80	(.031)
2 23*		A	1,60	(.063)

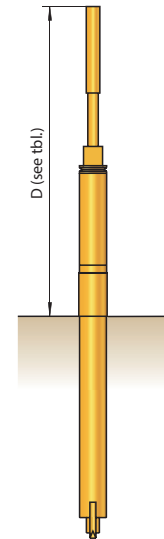

Part No.	A Tip- \varnothing mm (inch)	B Width of spade in mm (inch)	C Length of spade in mm (inch)	D Installation height with KS in mm (inch)	E Tip height in mm (inch)	F Total length mm (inch)
VF4 220 220 130 A 405 15	2,2 (.087)	1,3 (.051)	6,0 (.236)	40,5 (1.594)	12,5 (.492)	69,5 (2.736)
VF4 220 250 080 A 405 15	2,5 (.098)	0,8 (.031)	12,0 (.472)	46,5 (1.831)	18,5 (.728)	75,5 (2.972)
VF4 220 300 160 A 405 15	3,0 (.118)	1,6 (.063)	6,0 (.236)	40,5 (1.594)	12,5 (.492)	69,5 (2.736)

Installation height

Installation height with KS: see table

Mechanical data

Working stroke: 5,0 mm (.197)

Maximum stroke: 5,5 mm (.220)

Spring force at work. stroke: 15 N (54oz)

Alternative: 20 N (72oz); 25 N (90oz)

Materials

Barrel: Brass, gold-plated

Plunger: Steel, gold-plated

Spring: Steel, gold-plated

Receptacle: Bronze, gold-plated

Electrical data

Current rating: 8 A

R_i typical: < 30 m Ω

Mounting hole size

in CEM1 and FR4: $\varnothing 3,50$ mm (.1378)

Note:

Further tip styles are available upon request.

* Note:

The flat surface on the plunger tip is aligned with the flat surface on the rear of the plunger.

Recommended screw-in torque:

Min.: 3 cNm / Max.: 5 cNm

Ordering example

Series	Tip material 2 = Steel	Tip style	Tip diameter (A) (1/100 mm)	Width of spade (B) (1/100 mm)	Plating A = Gold	Installation height (D) (1/10 mm)	Spring force (N)
--------	---------------------------	-----------	-----------------------------------	-------------------------------------	---------------------	---	------------------------

Test probe with tip style 220:

V F 4 2 2 0 2 5 0 0 8 0 A 4 6 5 1 5

Test probe:

V F 4 2 0 2 1 8 0 A 1 5

Receptacle:

K S - V F 4

Grid:
 ≥ 5,08 mm
 ≥ 200 Mil

Installation height with KS: 36,7 mm (1.445)
Recommended stroke: 5,0 / 9,5 mm (.197 / .374)

Mounting and functional dimensions

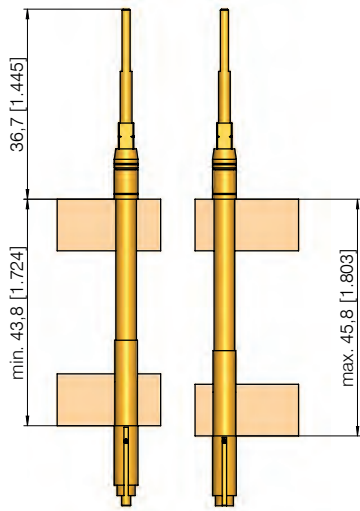
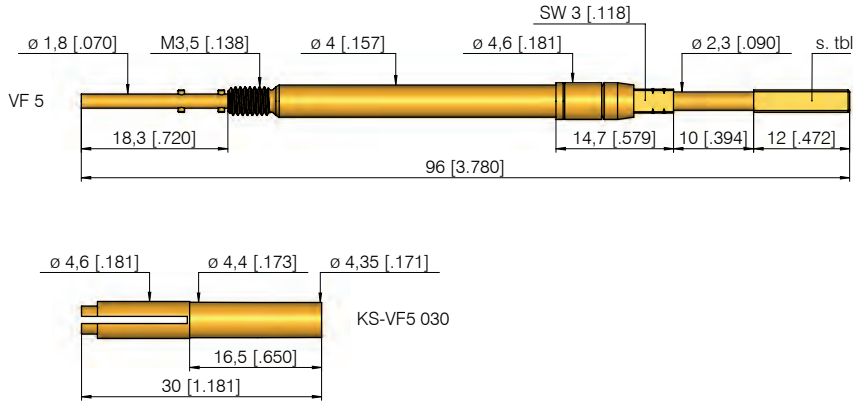

The VF 5 is mounted in the KS-VF5 030 which is pressed into a second plate to fix the receptacle securely and prevent rotation. The distance between the plates is 44.8 mm +/- 1 mm.

Available tip styles

Material	Tip style	Plating	Further versions	
			∅	∅ (inch)
3 20		A	1,40 (.055)	
3 20*		A	1,50* (.059)	
3 20		A	1,60 (.063)	
3 20		A	1,80 (.071)	

Note:

* Maximum stroke of VF5-320 150 A 096 with 15 N and 20 N = 10,0 mm (.394)

Note:

The flat surface on the plunger tip is aligned with the flat surface on the rear of the plunger.

Note:

To identify the spring force, the flat areas for the spanner are marked with notches:

- 1 notch 15 N (54oz)
- 2 notches 20 N (72oz)
- 3 notches 34 N (122oz)

Note:

The test probes are screwed in with specialised tools, shown on page 196.

Recommended screw-in torque:
 Min.: 10 cNm / Max.: 20 cNm

Mechanical data

Spring force at work. stroke	Pre-load	Working stroke in mm (inch)	Maximum stroke in mm (inch)
15 N (54oz)	2,7 N (10oz)	9,5 (.374)	10* (.394)/12 (.472)
20 N (72oz)	3,6 N (13oz)	9,5 (.374)	10* (.394)/12 (.472)
34 N (122oz)	10,0 N (36oz)	5,0 (.197)	6,5 (.256)

Materials

Barrel: Brass, gold-plated
Plunger: BeCu, gold-plated
Spring: Steel, gold-plated
Receptacle: Brass, gold-plated

Mounting hole size

for VF5 in CEM1 and FR4: ∅ 4,0 mm (.1575)
for KS-VF5 030 in CEM1 and FR4: ∅ 4,4 mm (.1732)

Operating temperature

Standard: -40° up to +80° C

Electrical data

Current rating: 10 A
R_j typical: < 30 mΩ

Ordering example

Series Tip material Tip style Spade width (1/100 mm) Plating Total length (dN) Spring force (N)

Test probe:

VF 5 3 2 0 1 5 0 A 0 9 6 2 0

Receptacle:

KS - VF 5 0 3 0

GKS 710

Non-Rotating Test Probe

Grid:

≥ 2,54 mm

≥ 100 Mil

Installation height with KS: 13,3/15,3/18,3 mm (.524/.602/.720)

Recommended stroke: 4,0 mm (.157)

Mounting and functional dimensions

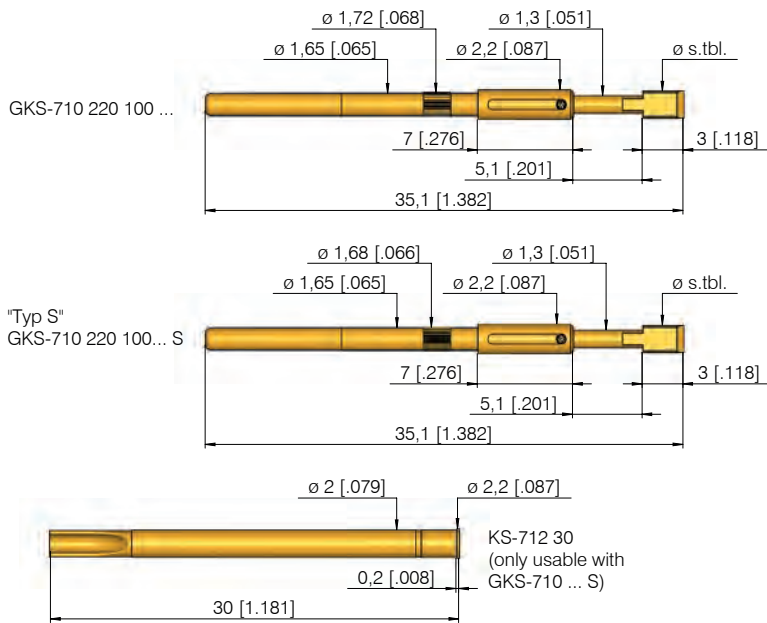

Available tip styles

Material	Tip styles	Plating	Further versions		
			Width of spade	Plating	Install. height (without KS)
2 20		1,00 (.039) A			15,1 mm (.594)
2 20*		0,50 (.020) R A	0,40	R	18,1 mm (.713)
2 21		0,50 (.020) A	1,30	A	15,1 mm (.594)
2 22		∅ 2,00 (.079) A			15,1 mm (.594)
2 23		∅ 1,30 (.051) R			13,1 mm (.516)
2 26		2,00 (.079) A			15,1 mm (.594)

* 3 mm longer as Standard

Collar height and installation height

The installation height at the tip (dimension without KS) is determined by the collar height and the tip length (see table "Available tip styles").

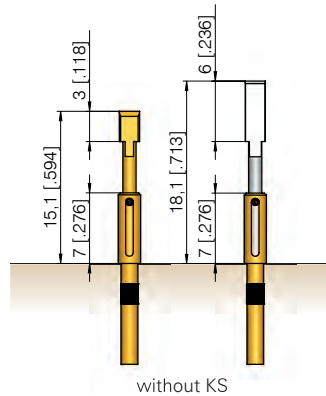

Mechanical data

Working stroke: 4,0 mm (.157)
Maximum stroke: 5,0 mm (.197)
Spring force at work. stroke: 1,5 N (5.4oz)
Alternative: 3,0 N (10.8oz); 5,0 N (18.1oz)

Electrical data

Current rating: 5 - 8 A
R_i typical: < 30 mΩ

Operating temperature

Standard: -40° up to +80° C

Materials

Plunger: Steel, gold- or rhodium-plated
Barrel: Brass, gold-plated
Spring: Steel, gold-plated
Receptacle: Brass, gold-plated

Mounting hole size

in CEM1 with receptacle: ∅ 1,98 - 2,00 mm (.0780 - .0787)
in FR4 with receptacle: ∅ 1,99 - 2,01 mm (.0783 - .0791)
without receptacle: ∅ 1,66 mm (.0654)

Note:

The knurl on the barrel of the test probe guarantees fits securely in the receptacle or directly into the probe plate.

Please specify special designation "S" when using receptacle KS-712 30.

Ordering example

Series	Tip material	Tip style	Tip diameter (1/100 mm)	Plating	Spring force (dN)	Collar height (mm)	Special designation (alternative "S")
GKS	2 = Steel			A = Gold			

Test probe:

G K S 7 1 0 2 2 0 1 0 0 R 1 5 0 7

Receptacle suitable for GKS-710 ... S:

K S - 7 1 2 3 0

Grid:
 ≥ 2,54 mm
 ≥ 100 Mil

Installation height with KS: 10,5 mm (.413)
Recommended stroke: 4,0 mm (.157)

Mounting and functional dimensions

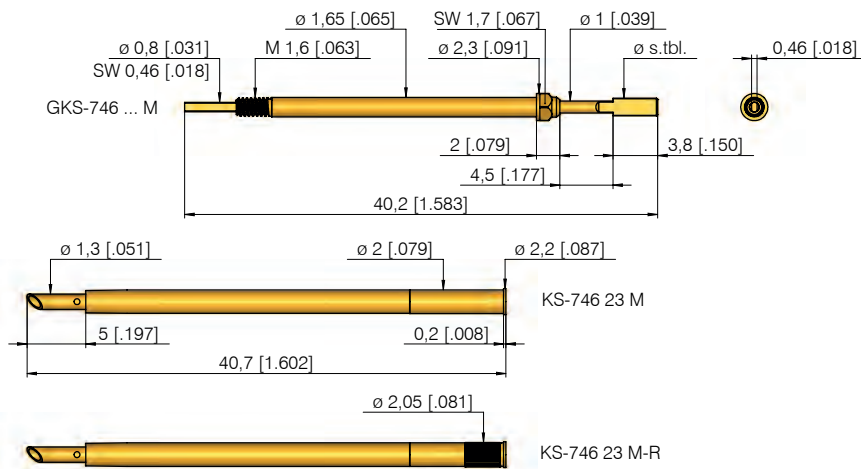

Available tip styles

Material	Tip style	Plating	Further versions	
			∅	∅ (inch)
3 05		A		
3 14		A		
3 20		A		
3 20		A		
3 20		A		
3 20		A		

Collar height and installation height

The installation height of the test probe is determined by the collar height of the receptacle.

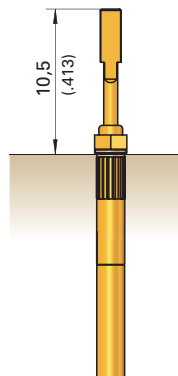

Collar height	Installation height with KS
02	10,5 mm (.413)

Mechanical data

Working stroke: 4,0 mm (.157)
Maximum stroke: 4,4 mm (.173)
Spring force at work. stroke: 1,5 N (5.4oz)
Alternative: 3,0 N (10.8oz)

Electrical data

Current rating: 5 - 8 A
R_i typical: < 30 mΩ

Operating temperature

Standard: -40° up to +80° C

Materials

Plunger: Steel or BeCu, gold-plated
Barrel: Brass, gold-plated
Spring: Steel, gold-plated
Receptacle: Brass, gold-plated

Mounting hole size

for KS-746 23 M
in CEM1 and FR4: ∅ 1,99 mm (.0783)
for KS-746 23 M-R
in CEM1 and FR4: ∅ 2,00 - 2,02 mm (.0787 - .0795)

Note:

When screwing the test probe into the receptacle, the plunger is secured against rotation. The flat surface at the end of the plunger fits into the slot at the end of the receptacle.

The assembled unit is then vacuum-sealed and can therefore be used for leakage tests.

The flat surface on the plunger tip is aligned with the flat surface on the rear of the plunger.

Recommended screw-in torque:
 Min.: 3 cNm / Max.: 5 cNm

Ordering example

Series	Tip material 3 = BeCu	Tip style	Tip diameter (1/100 mm)	Spade width (1/100 mm)	Plating A = Gold	Spring force (dN)	Collar height (mm)	Type
--------	--------------------------	-----------	----------------------------	---------------------------	---------------------	----------------------	-----------------------	------

Test probe:

G K S 7 4 6 3 2 0 1 5 0 0 5 0 A 1 5 0 2 M

Receptacle:

K S - 7 4 6 2 3 M

Screw-in tools:

K S - 7 4 6 2 3 M - R

GKS 747 M

Screw-in Non-Rotating Test Probe with Continuous Plunger

Grid:

≥ 4,50 mm

≥ 180 Mil

Installation height with KS: 16,2 / 20,2 mm (.638 / .795)

Recommended stroke: 4,0 mm (.157)

Mounting and functional dimensions

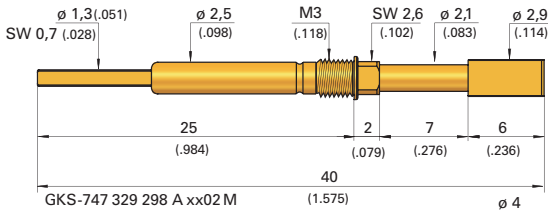

GKS-747 329 298 A xx02 M

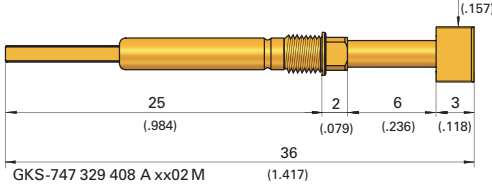

GKS-747 329 408 A xx02 M

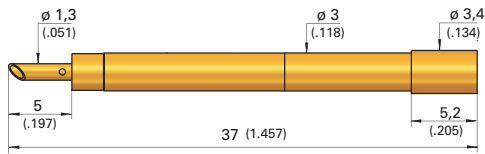

KS-747 23 M



KS-747 23 M-R

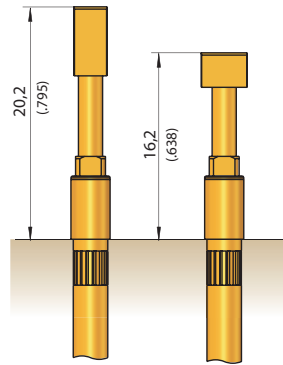

GKS -747 329 298 ... with KS

GKS -747 329 408 ... with KS

Collar height and installation height

The installation height at the tip (dimension without KS) is determined by the collar height and the tip length (see table "Available tip styles").

Mechanical data

Working stroke: 4,00 mm (.157)
Maximum stroke: 5,0 mm (.197)
Spring force at work. stroke: 1,5 N (5.4oz); 3,0 N (10.8oz)

Electrical data

Current rating: 8 A
R_i typical: < 30 mΩ

Operating temperature

Standard: -40° up to +80° C

Materials

Plunger: Steel or BeCu, gold-plated
Barrel: Brass, gold-plated
Spring: Steel, gold-plated
Receptacle: Brass, gold-plated

Mounting hole size

for KS-747 23 M in CEM1 and FR4: ∅ 2,99 mm (.1177)
 for KS-747 23 M-R in CEM1 and FR4: ∅ 3,00 - 3,02 mm (.1181 - .1189)

Available tip styles

Material	Tip style	Plating	Install. height with KS	
			Collar height	Install. height
3	29	A	02	20,2 (.795)
3	29	A	02	16,2 (.638)

Note:

When screwing the test probe into the receptacle, the plunger is secured against rotation. The flat surface at the end of the plunger fits into the slot at the end of the receptacle.

The assembled unit is then vacuum-sealed and can therefore be used for leakage tests.

The flat surface on the plunger tip is aligned with the flat surface on the rear of the plunger.

Recommended screw-in torque:
 Min.: 10 cNm / Max.: 20 cNm

Ordering example

Series	Tip material 3 = BeCu	Tip style	Tip diameter (1/100 mm)	Plating A = Gold	Spring force (dN)	Collar height (mm)	Type
--------	--------------------------	-----------	----------------------------	---------------------	----------------------	-----------------------	------

Test probe:

G K S 7 4 7 3 2 9 2 9 8 A 1 5 0 2 M

Receptacle:

K S - 7 4 7 2 3 M K S - 7 4 7 2 3 M - R

Grid:
 ≥ 4,50 mm
 ≥ 177 Mil

Installation height with KS: 18,3 mm (.720)
Recommended stroke: 6,4 mm (.252)

Mounting and functional dimensions

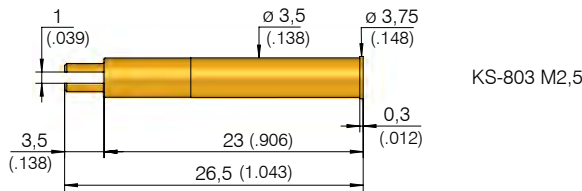
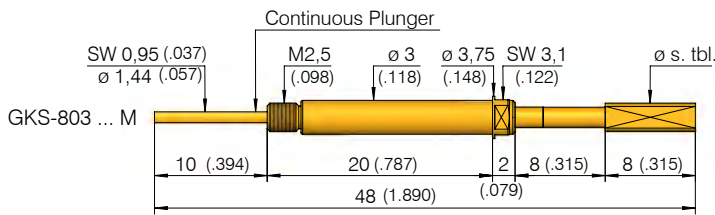

Available tip styles

Material	Tip style	Plating	Further versions	
			∅	∅ (inch)
1 02	0,8 ø2,5 208	A		
1 02	1,6 ø2,5 216	A		
3 02	ø 2,30 (.091)	A		
3 06	ø 3,00 (.118)	A		

Collar height and Installation height

The installation height of the tip is determined by the collar height.

Collar height	Installation height with KS
02	18,3 mm (.720)

Mechanical data

Working stroke: 6,4 mm (.252)
Maximum stroke: 8,0 mm (.315)
Spring force at work. stroke: 1,5 N (5.4oz); 5,0 N (18.1oz)

Electrical data

Current rating: 5 - 15 A
R_i typical: < 30 mΩ

Operating temperature

Standard: -40° up to +80° C

Materials

Plunger: BeCu, gold-plated
Plunger head: BeCu or brass, gold-plated
Barrel: Brass, gold-plated
Spring: Stainless steel
Receptacle: Brass, gold-plated

Mounting hole size

in CEM1 and FR4: ø 3,49 mm (.1374)

Note:

When screwing the test probe into the receptacle the plunger is secured against rotation. The flat section at the end of the plunger moves into the slit at the end of the receptacle.

Note:

Plunger tip with flat section: the flat section of the plunger tip is set at 90° to the flat section at the end of the plunger.

Recommended screw-in torque:
 Min.: 10 cNm / Max.: 20 cNm

Ordering example

Series	Tip material	Tip style	Tip diameter (1/100 mm)	Plating	Spring force (dN)	Collar height (mm)	Type
	1 = Brass 3 = BeCu			A = Gold			

Test probe:

G K S 8 0 3 3 0 6 3 0 0 A 1 5 0 2 M

Receptacle:

K S - 8 0 3 M 2.5

GKS 714 / 098

Non-Rotating Test Probe

Grid:

≥ 5,08 mm

≥ 200 Mil

Installation height: see below

Recommended stroke: 4,0 / 6,0 mm (.157 / .236)

Mounting and functional dimensions

GKS-714 ... 07

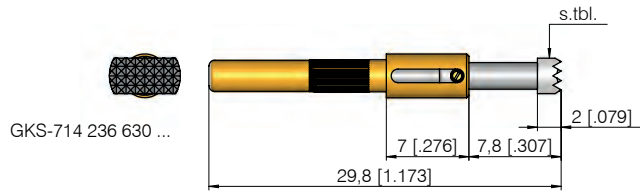
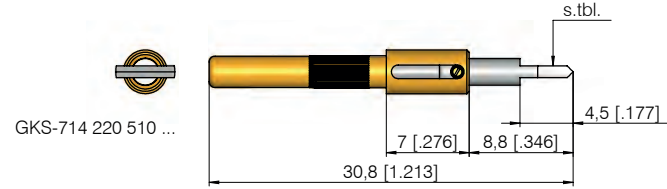
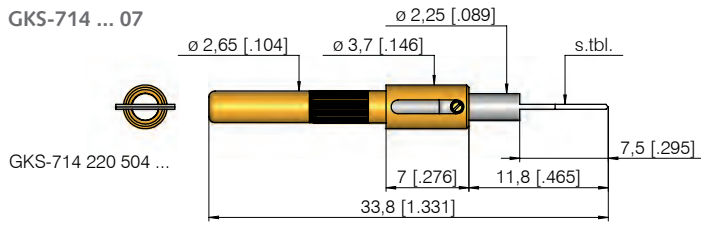

GKS-714 ... 10

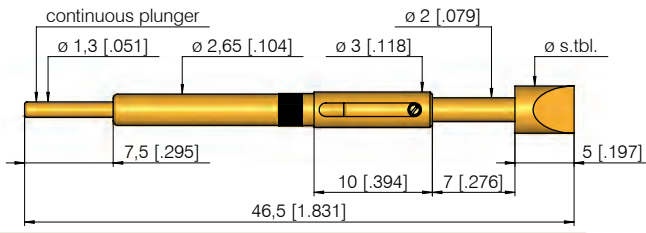

GKS-098 ... 07

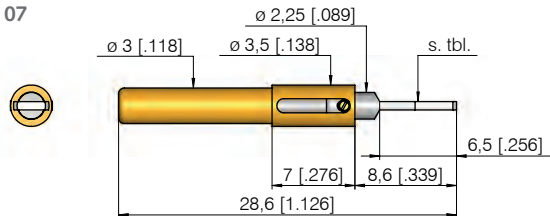

Mechanical data

Spring force at work. stroke: 1,5 N (5.4oz)
alternativ: 3,0 N (10.8oz); 5,0 N (18.1oz)

	714...07	714...10	098...07
Working stroke	4,0 mm (.157)	6,0 mm (.236)	4,0 mm (.157)
Maxim. stroke	5,0 mm (.197)	7,0 mm (.276)	5,0 mm (.197)

Electrical data

Current rating: 8 - 10 A
R_i typical: < 30 mΩ

Operating temperature

Standard: -40° up to +80° C

Material

Plunger: Steel or BeCu, gold- or rhodium-plated
Barrel: Brass, gold-plated
Spring: Steel, gold-plated
Receptacle: Brass, gold-plated

Mounting hole size for GKS-714

with receptacle: ∅ 2,98 - 2,99 mm (.1173 - .1177)
without receptacle: ∅ 2,66 mm (.1047)

Mounting hole size for GKS-098

with receptacle: ∅ 3,48 - 3,49 mm (.1370 - .1374)

Available tip styles

GKS-714 ... 07

Material	Tip style	Plating	Install. and Functional Dim.	
			Collar height	Install. height
2 20		R	E 07	18,8 (.740)
2 20		R	E 07	15,8 (.622)
2 36		R	E 07	14,8 (.583)

Available tip styles

GKS-714 ... 10

Material	Tip style	Plating	Install. and Functional Dim.	
			Collar height	Install. height
2 22		A	E 10	22,0 (.866)
2 23		A	E 10	22,0 (.866)
2 23		A	E 10	22,0 (.866)

Available tip styles

GKS-098 ... 07

Material	Tip style	Plating	Install. and Functional Dim.	
			Collar height	Install. height
3 29		R	E 07	15,5 (.610)

Collar height and Installation height

The installation height at the tip (dimension without KS) is determined by the collar height and the tip length (see table "Available tip styles").

Note:

Receptacles from the KS-714 23 series are used for the test probes series 714 (dimensions same as KS-113 23, see page 68).

KS-103 23 receptacles (show on page 70) are used for test probes in the series GKS-098.

Ordering example

Series	Tip material	Tip style	Tip diameter (1/100 mm)	Plating	Spring force (dN)	Collar height (mm)
2	2 = Steel	20	2,25	R = Rhodium	1,5	15,0
3	3 = BeCu	36	2,25	R = Rhodium	1,5	15,0

Test probe:

G K S 7 1 4 2 2 0 5 0 4 R 1 5 0 7

Test probe:

G K S 0 9 8 3 2 9 3 0 0 R 1 5 0 7

Lamellar plug for type 714 E10:

S E - 5 0 3 (cannot be used with KS)

Receptacle for GKS 714:

K S - 7 1 4 2 3

Receptacle for GKS 098:

K S - 1 0 3 2 3

Grid:
 ≥ 5,08 mm
 ≥ 200 Mil

Installation height: 15,3 mm (.602)
Recommended stroke: 4,0 mm (.157)

Mounting and functional dimensions

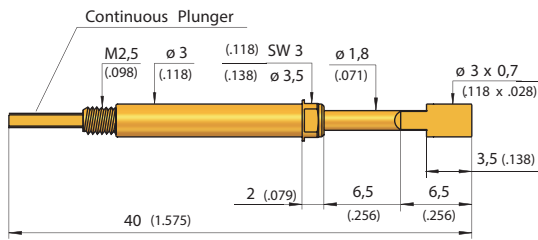

GKS-098 329 300 070 A xx02 ML

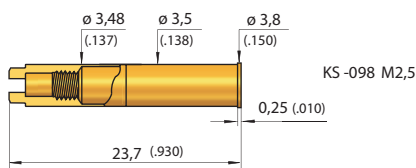

KS-098 M2,5

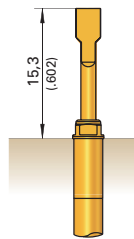

GKS-098 ... ML
 in KS-098 M2,5

Installation height with KS

Install. height "ML": 15,3 mm (.602)

Mechanical data

Working stroke: 4,0 mm (.157)
Maximum stroke: 5,0 mm (.197)
Spring force at work. stroke: 1,5 N (5.4oz);
 3,0 N (10.8oz)

Materials

Plunger: BeCu, gold-plated
Barrel: Brass, gold-plated
Spring: Steel, gold-plated
Receptacle: Brass, gold-plated

Electrical data

Current rating: 10 A
R_i typical: < 30 mΩ

Mounting hole size

in CEM1 and FR4: ∅ 3,48 - 3,49 mm
 (.1370 - .1374)

Operating temperature

Standard: -40° up to +80° C

Note:

Further versions available upon request.

Note:

When screwing the test probe into the receptacle, the plunger will be secured against rotation. The flat surface at the end of the plunger fits into the slot at the end of the receptacle.

The flat surface on the plunger tip is aligned with the flat surface on the rear of the plunger.

Recommended screw-in torque:
 Min.: 10 cNm / Max.: 20 cNm

Ordering example

Series	Tip material	Tip style	Tip diameter	Spade width	Plating	Spring force	Collar height	Type
GKS	3 = BeCu	098	(1/100 mm)	(1/100 mm)	A = Gold	(dN)	(mm)	
329								
300								
070								
A								
15								
02								
ML								
KS-098								
M2.5								

Test probe:

Receptacle:

Dipole Test Probes and RF Test Probes Plug Connectors and PCB Test Points Contacting

Dipole test probes and RF test probes are used in various industries: They enable precise, accurately repeatable measurement of resistance as well as RF performance.

Using **dipole test probes**, **4-wire measurements** to accurately determine resistances can be performed. In doing so, the voltage is measured using the inner conductor and the current is measured using the outer conductor.

RF test probes are used to contact plug connectors, mini switches and PCB test points. These are used in the following way:

Plug connectors are used to connect a variety of RF components, such as cables and PCB modules. In the automotive industry, plug connectors such as FAKRA or HSD connectors are used to transmit audio and video signals. U.FL connectors are used in radio modules, among others.

Mini switches are used to test RF signals which are supplied by chip antennas or PCB antennas.

PCB test points allow RF signals to be contacted directly on to the PC board. Depending on the nature of the PC board and application, this is carried out in various ways.

Assorted application of dipole GKS and RF test probes

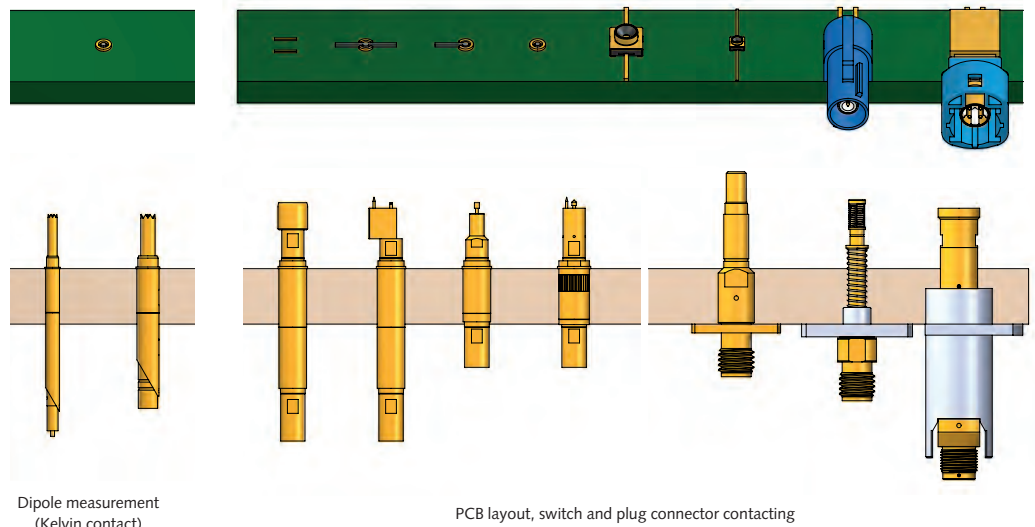

Frequency / series	Dipole test probe / Dipole RF test probe Kelvin measurement	Standard RF test probe press-in / screw-in	Flange RF test probe rigid flange/ floating bearing
Various	NEW DPS-215 M / DPS-465 M NEW HFS-010 / HFS-110	HFS-819	HFS-821 / HFS-864 / HFS-409 / test connector
2 GHz	-	HFS-810 (M) / HFS-410 (M)	-
4 GHz	-	HFS-840 (M) / HFS-440 (M)	-
6 GHz	-	HFS-860 (M)	HFS-852 / HFS-822
12 GHz	-	HFS-865 (M)	HFS-856
Page(s)	156 - 159	See RF catalogue	See RF catalogue

The **dipole test probes** developed by INGUN are highly suitable for performing 4-wire measurements thanks to their coaxial design. This allows the voltage to be measured directly on the contact surface and the resistance to be determined. Furthermore, it is also possible to perform connection tests on coaxial plug connectors.

Depending on the application, variable grid sizes, tip styles and dimensions are available.

Dipole test probes are installed using a receptacle. The connection is made using either a connector or by soldering on the receptacle.

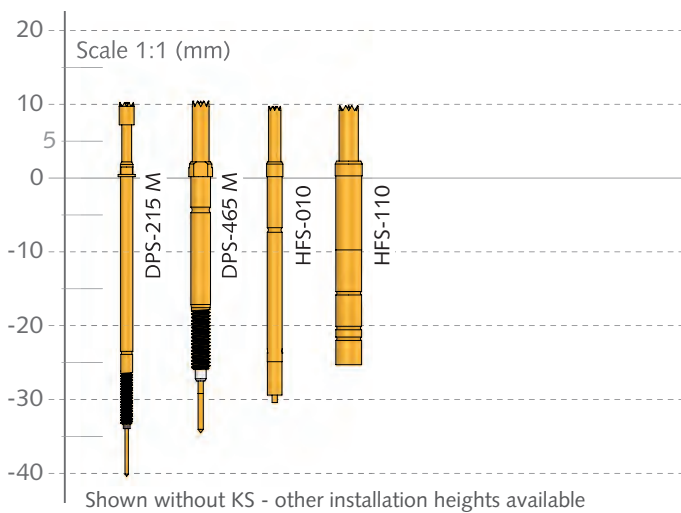

To optimally fulfill the requirements in radio frequency testing, various versions of the **RF test probes** are available. Selection criteria for choosing a suitable RF test probe include the test point to be contacted, the frequency or data rate, the installation area (the space available for probe installation) as well as the ambient conditions.

A comprehensive overview of the RF test probes available can be found in the latest RF test probe catalogue.

Dipole GKS

DPS-215 M	NEW	156
DPS-465 M	NEW	157

Dipole HFS

HFS-010	158
HFS-110	159

Standard HFS

- HFS-810 (M)
- HFS-840 (M)
- HFS-860 (M)
- HFS-865

Short HFS

- HFS-410 (M)
- HFS-440 (M)

Flange HFS

- HFS-409
- HFS-821
- HFS-822
- HFS-823
- HFS-852
- HFS-856
- HFS-864

Plug Connectors

>>> see RF-catalogue

Note:

See next page for overview and comparison table

Dipole and HFS Test Probes (see RF Catalogue) Overview and Comparison

	Standard RF test probes pressed in / screwed in				Short RF test probes pressed in / screwed in		Flange RF test probes fixed flange / floating flange						RF test probes assorted	
	HFS-810	HFS-840	HFS-860	HFS-865	HFS-410	HFS-440	HFS-819	HFS-821	HFS-822	HFS-823	HFS-852	HFS-856		
RF test probe series	HFS-810	HFS-840	HFS-860	HFS-865	HFS-410	HFS-440	HFS-819	HFS-821	HFS-822	HFS-823	HFS-852	HFS-856	s. bottom	
Frequency or Gbit/s	2 GHz	4 GHz	6 GHz	12 GHz	2 GHz	4 GHz	Gbit/s	Gbit/s	6 GHz	8 GHz	6 GHz	6 GHz		
Cable movement upon contact	yes	yes	yes	yes	yes	yes	yes	yes	no	no	yes	yes		
Image														
Plug connectors	1.0/2.3	x	x			x	x							
	7/16													HFS-864
	BMA	x	x			x	x							
	BNC	x	x			x	x							
	F													HFS-409
	FAKRA	x	x			x	x							
	FME	x	x			x	x							
	GT13	x	x			x	x							
	GT16	x	x			x	x							
	HDMI													PS-HDMI
	HSD							x						
	IEC													HFS-409
	MBX	x	x			x	x			x				
	MCX	x	x	x		x	x							
	MM5829									x				
	MMBX	x	x		x	x	x							
	MMCX	x	x			x	x							
	MMPX				x									
	MX-series								x					
	N	x		x		x								
	PC3.5				x									
	P-SMP									x				
	QMA			x										
	RJ-series													PS-RJ
	R-SMA			x										
	R-TNC	x	x			x	x							
	SMA	x	x	x	x	x	x							
	SMB	x	x			x	x							
	SMC	x	x			x	x							
	SMP	x	x			x	x						x	
	SMP-L									x				
	SMP-MAX									x				
	SMPX				x									
	SSMP			x										
	TAE													PS-TAE
	U.FL	x	x	x		x	x			x		x	x	
USB-series								x					PS-USB	
W.-FL			x										x	
W.-FL2			x										x	
X.FL			x										x	
RF switches	MM8030, MM8130, MM8430			x	x					x			x	
	MS-156, MS-180			x						x			x	
	Pico II, PN 1551372-1			x	x					x			x	
PCB	Coaxial dipole probes / Kelvin measurement												HFS-010, HFS-110, DPS-215, DPS-465	
	PCB coax closed / (75 ohm)	x	x			x	x						HFS-858	
	PCB coax kidney-shaped	x	x	x		x	x							
	PCB coax open / (75 ohm)	x	x	x		x	x						HFS-858	
	PCB-GSG / PCB-GGSGG	x	x			x	x						HFS-836	
	PCB-SG / PCB-SG-compensation	x	x			x	x						HFS-837	
	PCB lateral test point	x	x			x	x							

All RF test probes available from INGUN are listed in the table above. The optimal test solution can be selected based on the test point (plug connection, RF switch or PCB layout) and the frequency required.

The new RF-Probes Catalogue

Optimal test solutions for your challenging analog and digital RF applications.

ingun[®]
Test Probes - Test Fixtures

TESTING SOLUTIONS IN THE
No.1 POSITION
IN MICROELECTRONICS

RF-Probes
Plug Connector, Miniature Switch
and PCB Contacting

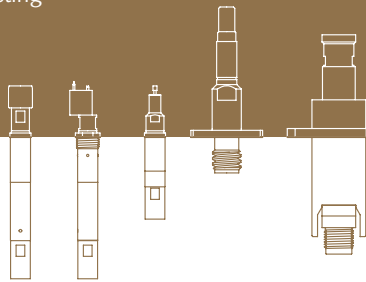

Besides general mechanical and electrical data, INGUN provides scattering parameter graphs for several product types.

Find a downloadable version the RF probes catalogue on our website:
www.ingun.com

Catalogue 5.1

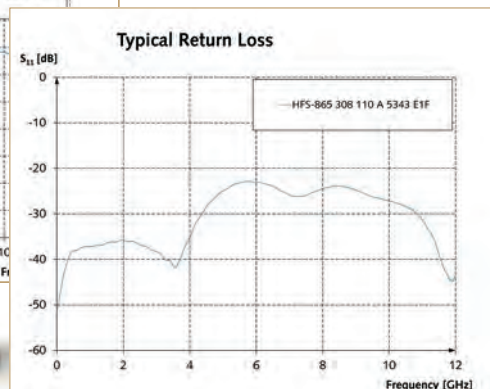
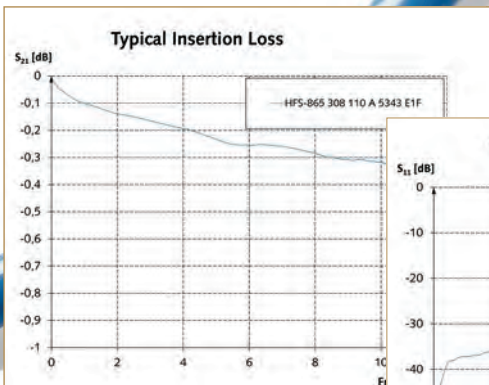

DPS-215 M

Coaxial Dipole Probe

NEW

Grid:

≥ 2,54 mm

≥ 100 Mil

Installation height with KS: 10,2 mm (.402)

Recommended stroke: 4,0 mm (.157)

Mounting and functional dimensions

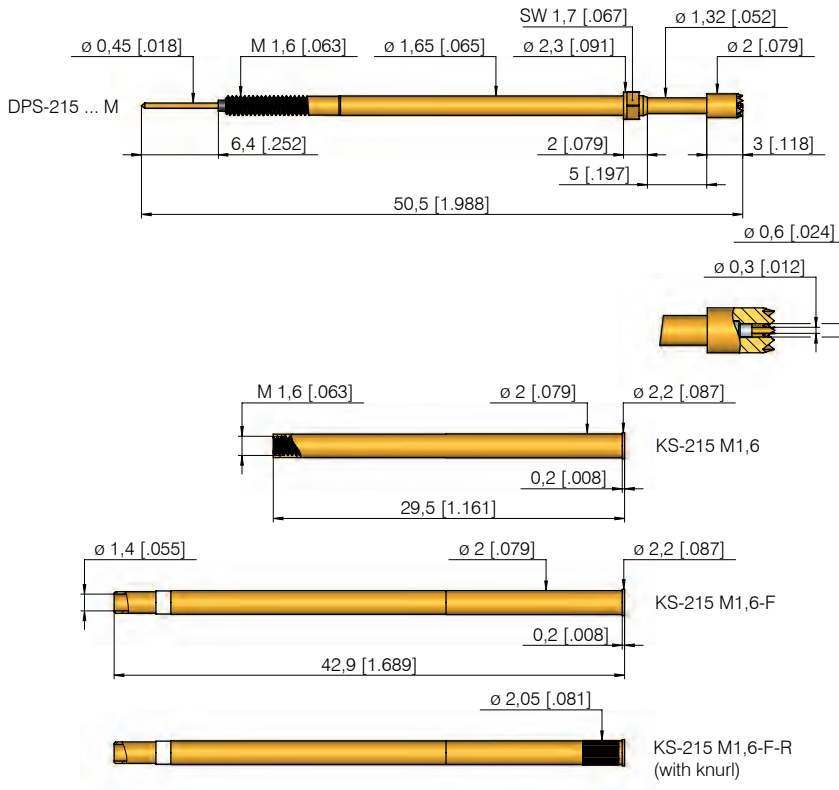

Available tip styles

inner conductor

Material	Tip style	Plating	Further versions	
			∅	∅ (inch)
3 04		A		

Available tip styles

outer conductor

Material	Tip style	Plating	Further versions	
			∅	∅ (inch)
3 06		A		

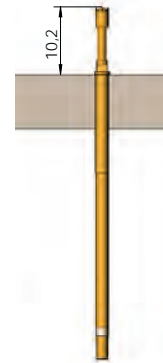

DPS-215...06 M
with KS-215 M1,6 F

Mechanical data

Working stroke: 4,0 mm (.157)
Maximum stroke: 5,0 mm (.197)
Spring force at working stroke
 - outer conductor: 1,6 N (5.7oz)
 - inner conductor: 0,4 N (1.4oz)

Electrical data

Current rating outer conductor: 8 A
Current rating inner conductor: 2 A
R_i typical: < 20 mΩ

Operating temperature

Standard: -40 up to +80 °C

Materials

Plunger: BeCu, gold-plated
Barrel: Brass, gold-plated
Spring: Steel, gold-plated
Receptacle: Brass, gold-plated
Insulation: PTFE

Mounting hole size

KS with knurl ∅ 2,00 - 2,02 mm
 in CEM1 and FR4 (.079 - .080)
KS without knurl ∅ 1,99 mm (.078)
 in CEM1 and FR4

Note:

The receptacle KS-215 M1,6 (-F/-F-R) can be used from grid size 2,54 mm (100 Mil) upwards.

Note:

The inner conductor is fixed in the probe, and therefore cannot be changed.

Note:

Recommended screw-in torque:
 Min.: 3 cNm / Max.: 5 cNm.

Ordering example

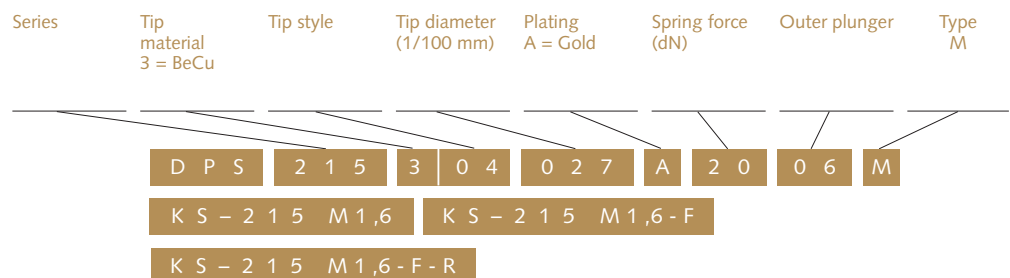

NEW

DPS-465 M

Coaxial Dipole Probe

Grid:
≥ 3,50 mm
≥ 140 Mil

Installation height with KS: 10,4 mm (.395)
Recommended stroke: 4,0 mm (.157)

Mounting and functional dimensions

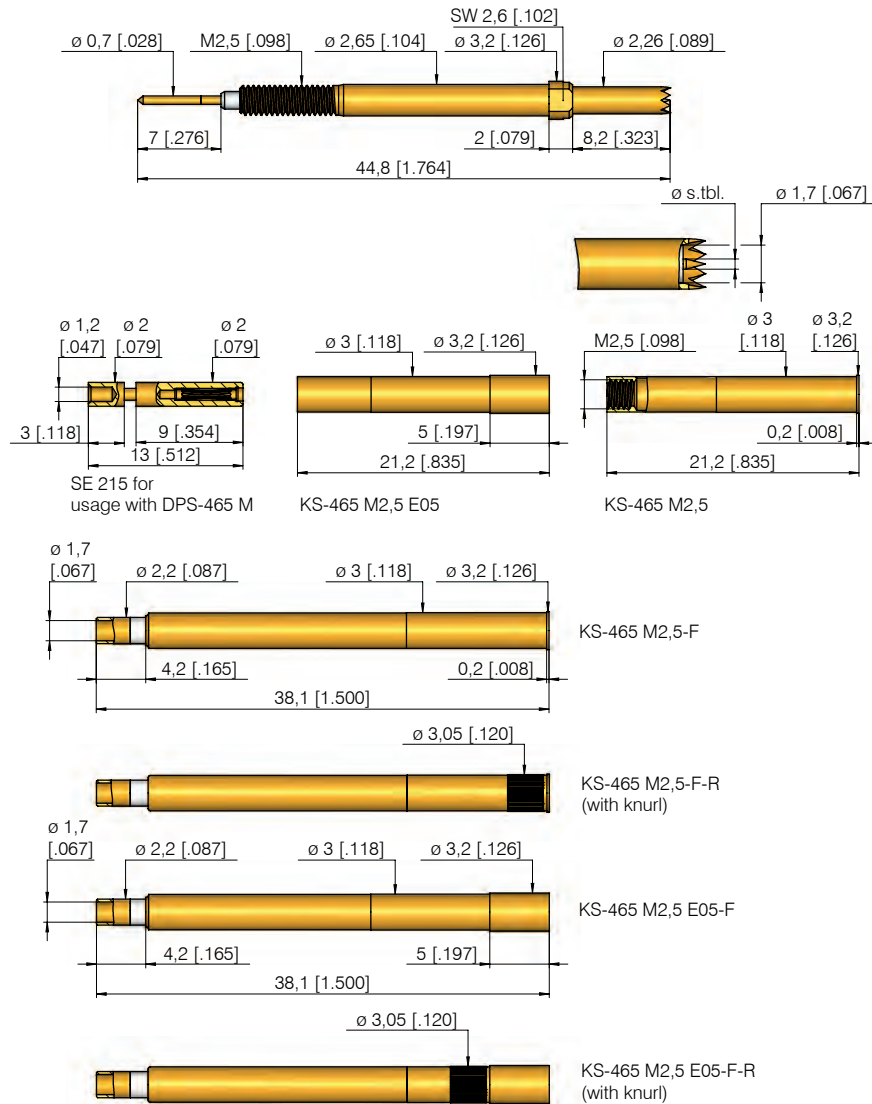

Available tip styles inner conductor

Material	Tip-styles	Plating	Further versions	
			∅	∅ (inch)
3 02		A	∅ 0,50 (.020)	
3 06		A	∅ 1,00 (.039)	
3 51		A	∅ 0,50 (.020)	
3 54		A	∅ 1,00 (.039)	

Available tip styles outer conductor

Material	Tip-styles	Plating	Further versions	
			∅	∅ (inch)
3 02		A	∅ 2,26 (.089)	
3 06		A	∅ 2,26 (.089)	



DPS-465...02 M with KS-465 M2,5

Mechanical data

Working stroke: 4,0 mm (.157)
Maximum stroke: 5,0 mm (.197)
Spring force at working stroke
 - outer conductor: 3,0 N (10.7oz)
 - inner conductor: 1,0 N (3.6oz)

Electrical data

Current rating outer conductor: 10 A
Current rating inner conductor: 2 A
R_i typical: < 20 mΩ

Operating temperature

Standard: -40 up to +80 °C

Materials

Plunger: BeCu, gold-plated
Barrel: Brass, gold-plated
Spring: Steel, gold-plated
Receptacle: Brass, gold-plated
Insulation: PTFE

Mounting hole size

KS without knurl in CEM1 and FR4 ∅ 2,98 - 2,99 mm (.117 - .118)
KS with knurl in CEM1 and FR4 ∅ 3,00 - 3,02 mm (.118 - .119)

Note:

Recommended screw-in torque:
Min.: 3 cNm / Max.: 5 cNm.

Note:

The inner conductor is fixed in the probe, and therefore cannot be changed.

Ordering example

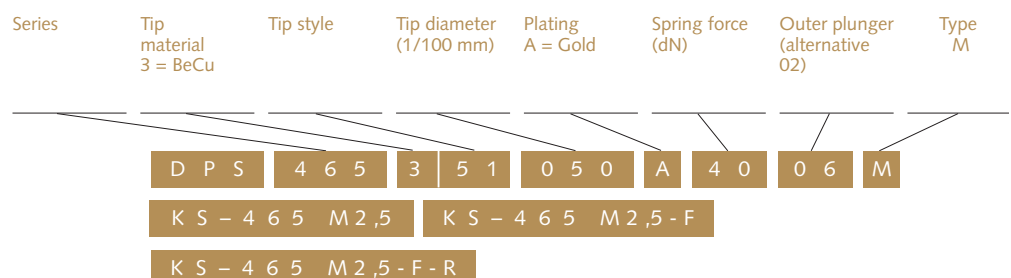

HFS 010

Coaxial Dipole Probe/RF-Test Probe, 50 Ω, 200 MHz

Grid:

≥ 2,54 mm

≥ 100 Mil

Installation height with KS: 9,75 mm (.384)

Recommended stroke: 5,5 mm (.217)

Mounting and functional dimensions

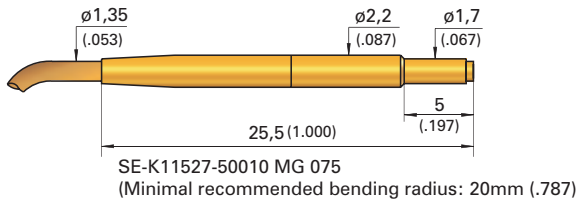
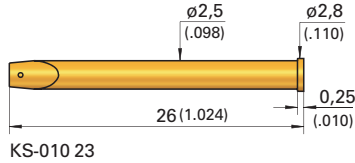
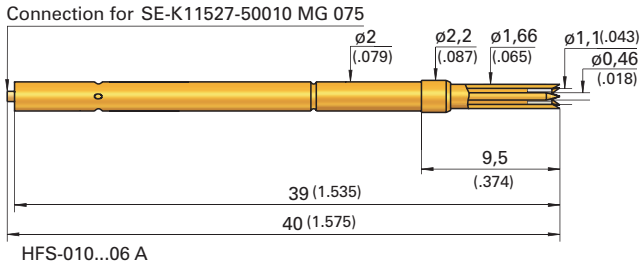

Available tip styles inner conductor

Material	Tip style	Plating	Further versions	
			∅	∅ (inch)
3	51	A	∅ 0,50 (.020)	
3	54	A	∅ 0,50 (.020)	

Available tip styles outer plunger

02	
06	

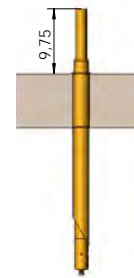

HFS-010
with KS-010 23

Mechanical data

Working stroke:	5,5 mm (.217)
Maximum stroke:	7,5 mm (.295)
Spring force at working stroke	
- outer conductor:	1,2 N (4.3oz)
- inner conductor:	0,8 N (2.9oz)

Electrical data

Frequency range:	up to 200 MHz
Current rating:	3 A
R _i typical:	< 20 mΩ
Impedance test probe:	25 - 30 Ω
	200 MHz
Impedance cable:	50 Ω/200 MHz
	90 pf/m

Operating temperature

Standard:	-40 up to +80 °C
-----------	------------------

Materials

Plunger:	BeCu, gold-plated
Barrel:	Brass, gold-plated
Spring:	Steel, gold-plated
Receptacle:	Brass, gold-plated
Insulation:	Delrin

Mounting hole size

with receptacle:	∅ 2,48 - 2,49 mm (.0976 - .0980)
without receptacle:	∅ 2,00 mm (.0787)

Note:

The receptacle KS-010 23 can be used from grid size 3,00 mm (120 Mil) up.

Note:

The inner conductor is fixed in the probe, and therefore cannot be changed.

The spring-loaded outer plunger of the HFS-010 is also available with a shorter assembly length upon request.

Ordering example

Series	Tip material 3 = BeCu	Tip style	Tip diameter (1/100 mm)	Plating A = Gold	Spring force (dN)	Outer plunger (alternative 06)	Type
HFS	010	3	51	050	A	20	02 A
KS - 010 23							
SE - K 11 5 2 7 - 5 0 0 1 0 M G 0 7 5							

Test probe:

Receptacle:

Plug with RF coaxial cable, pre-wired,
length 0,75 m (custom length on request):

Grid:
 ≥ 4,50 mm
 ≥ 177 Mil

Installation height with KS: 9,8 mm (.386)
Recommended stroke: 4,0 mm (.157)

Mounting and functional dimensions

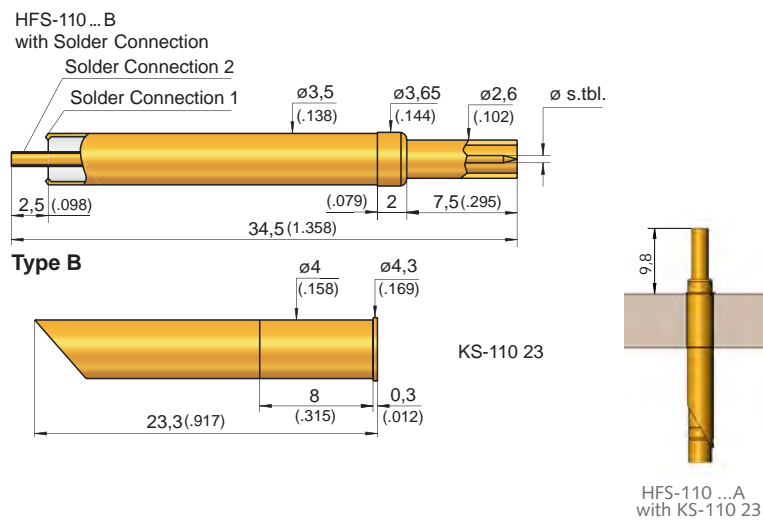
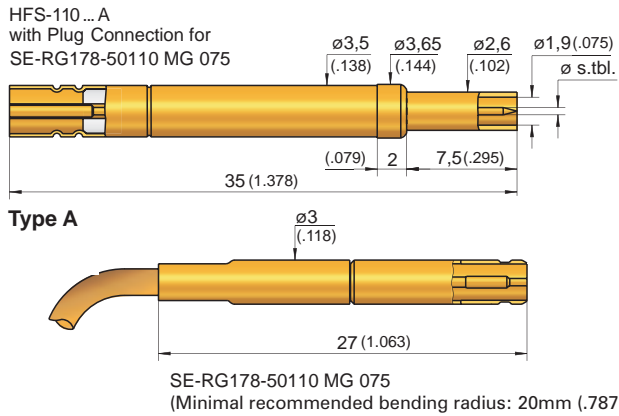

Available tip styles inner conductor				
Material	Tip style	Plating	Further versions	
			∅	∅ (inch)
3 01		A	∅ 0,50 (.020)	
3 02		A	∅ 0,50 (.020)	
3 03		A	∅ 1,15 (.045)	
3 04		A	∅ 1,15 (.045)	
3 05		A	∅ 1,15 (.045)	
3 06		A	∅ 1,15 (.045)	
3 07		A	∅ 1,00 (.039)	
3 08		A	∅ 1,15 (.045)	

Available tip styles outer plunger	
02	
06	

Mechanical data

Working stroke: 4,0 mm (.157)
Maximum stroke: 5,0 mm (.197)
Spring force at working stroke
 - outer conductor: 3,0 N (10.8oz)
 - inner conductor: 1,5 N (5.4oz)

Materials

Plunger: BeCu, gold-plated
Barrel: Brass, gold-plated
Spring: Steel, gold-plated
Receptacle: Brass, gold-plated
Insulation: Teflon

Note:
 The inner conductor is fixed in the probe, and therefore cannot be changed.

Electrical data

Frequency range: up to 700 MHz
Current rating: 3 A
R_i typical: < 20 mΩ
Impedance test probe: 50 Ω
Impedance cable: 50 Ω

Mounting hole size

with receptacle: ∅ 3,98 - 3,99 mm (.1567 - .1571)
without receptacle: ∅ 3,50 mm (.1378)

Operating temperature
Standard: -40° up to +80 °C

Ordering example

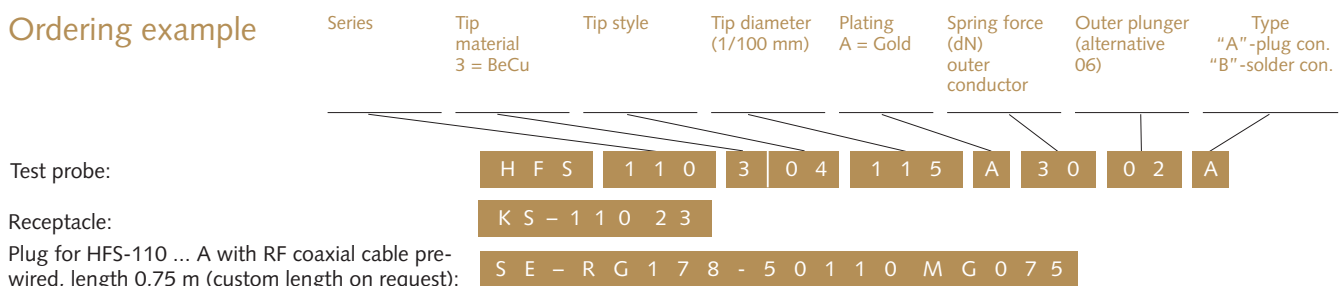

Pneumatic Test Probes

Pneumatic Switching Probes

Pneumatic test probes (PKS) are used in all industries and a multitude of applications. These include individual contacting of single test points, activation of switches, contacting of difficult-to-access test points, or creation of interface blocks.

A big advantage is that individual contact points can be contacted without the need for a complete test fixture. The pneumatic test probes rest in the home position (plunger in

barrel) and the plunger extends when pressure is applied. PKS can be operated in groups or individually, allowing individual test sequences to be created. A wide range of accessories are available for doing so.

The installation and electrical connection of PKS is made using either a standard receptacle, or a quick-exchange receptacle.

Various uses of pneumatic test probes

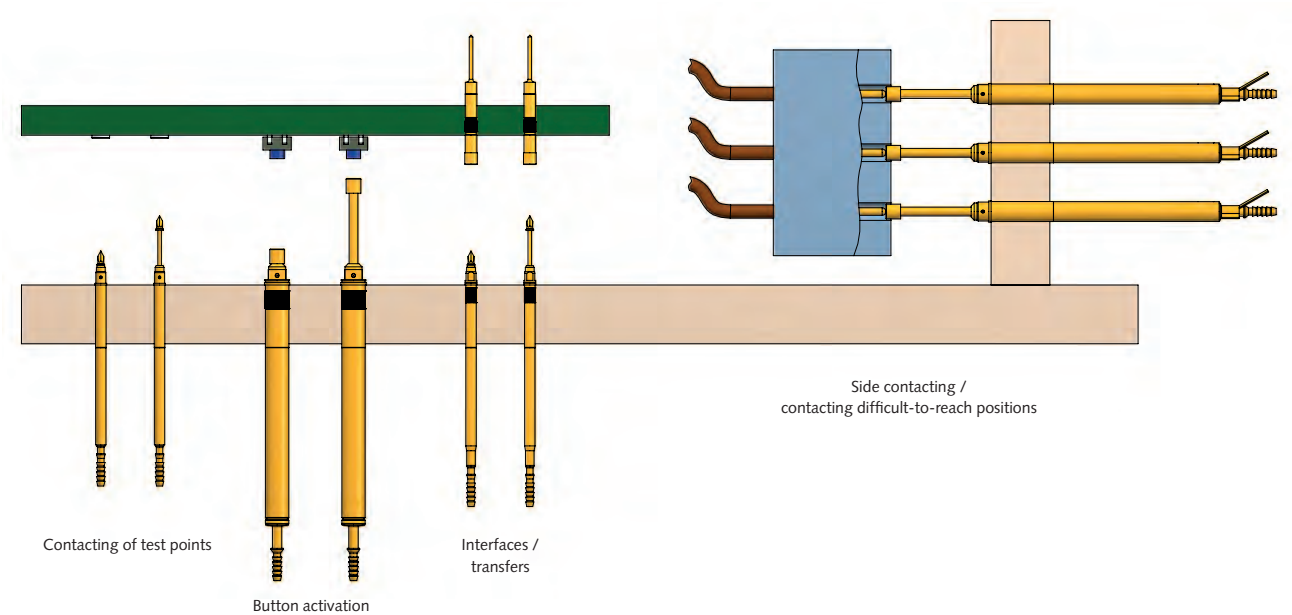

Grid size / Type of installation	≥ 1.91 mm (≥ 75 Mil)	≥ 2.54 mm (≥ 100 Mil)	≥ 3.50 mm (≥ 140 Mil)	≥ 4.50 mm (≥ 180 Mil)
Pressed into receptacle	PKS-171	PKS-200 (Type A/B) PKS-220 (Type A/B)	PKS-299 Type B PKS-300 (Type A/B)	PKS-399 (Type1/2) PKS-420 (Type1/2)
Screwed into quick-exchange system		PKS-171 M	PKS-355 M PSK-350 M (Pneumatic switching probe)	PKS-388 M
Page(s)	163	164 - 165 / 170	166 - 167 / 171 / 173	168 - 169 / 172

Pneumatic test probes are operated by pressurised air. In the resting position the plunger is inside the barrel and is moved outwards when pressurised air is applied. The spring inside returns the plunger back to the home position after the pressurised air is removed.

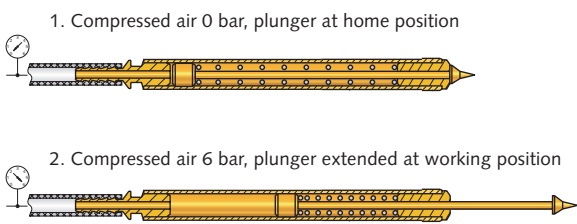

The installation and electrical connection of PKS are made using either a standard receptacle, or a quick-exchange receptacle. When using a quick-exchange receptacle, the cable is either soldered or clipped directly onto the receptacle, and the pressurised air hose is connected to the tail end of the receptacle. This is a real advantage in terms of maintenance, as probes can be exchanged without the need for rewiring, or replacing the hose connection.

The available contact force of pneumatic test probes behaves in completely the opposite way from that of spring-loaded test probes. This means that the further the plunger is moved outwards, the lower the contact force becomes (spring force of the recoil spring works against this).



Our pneumatic test probes are designed as incomplete machines and meet the stipulations of the Machine Directive 2006/42/EG.

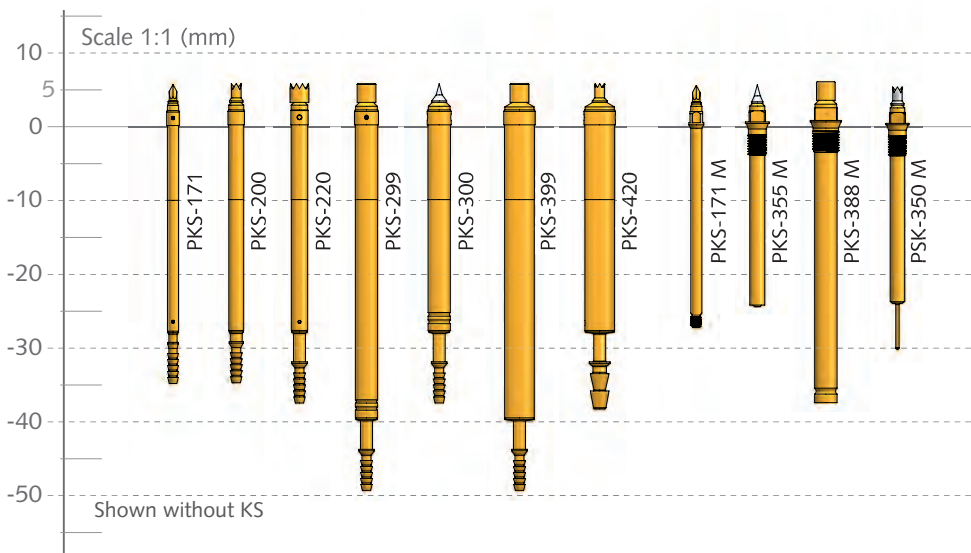

Pneumatic Test Probes

Press-in Probes

PKS-171	163
PKS-200	164
PKS-220	165
PKS-299	166
PKS-300	167
PKS-399	168
PKS-420	168

Screw-in Probes

PKS-171 M	170
PKS-355 M	171
PKS-388 M	172

Pneumatic Switching Probes

PSK-350 M	173
-----------	-----

Accessories PKS 174 - 175

Note:
See next page for overview and comparison table.

Pneumatic Test Probes

Overview and Comparison

Pneumatic test probe version	Series	Grid size (≥ mm)	Working stroke (mm)	Max. stroke (mm)	Max. rated current (A)	Contact force - working stroke (N)	Possible installation heights with receptacle (KS) (mm)		Min. length PKS (mm)	Page
							home position	extended		
Press-in probes	PKS-171	1.91	6	10	1 – 2	0.3	5.8	11.8	40	163
	PKS-200	2.54	6	10	1 – 2	0.6	5.9	11.9	40/42.7	164
	PKS-220	2.54	6	10	2 – 3	0.8	5.9	11.9	40/42.7	165
	PKS-299	3.5	12	20	3/10	1.7	5.9	17.9	54.4	166
	PKS-300	3.5	6	10	3/10	1.1 / 1.5	5.9	11.9	40/42.7	167
	PKS-399	4.5	12	20	3/10	3.7 / 4.2	5.9	17.9	54.4	168
	PKS-420	4.5	6	10	3/10	3.7 / 4.2	5.9	11.9	42.7	169
Screw-in probes	PKS-171 M	2.54	6	10	1 – 2	0.3	5.8	11.8	32.5	170
	PKS-355 M	3.5	6	10	1 – 2	0.6	5.7	11.7	29.8	171
	PKS-388 M	4.5	12	20	3/10	1.7	6.1	18.1	43.1	172
Pneumatic switching probe	PSK-350 M	3.5	6	10	1 – 2	0.6	5.7	11.7	36.2	173
Accessories PKS	Accessories	-	-	-	-	-	-	-	-	174/175

Grid:
 ≥ 1,91 mm
 ≥ 75 Mil

Installation height with KS: 5,8 mm (.228)
Recommended stroke: 6,0 mm (.236)

Mounting and functional dimensions

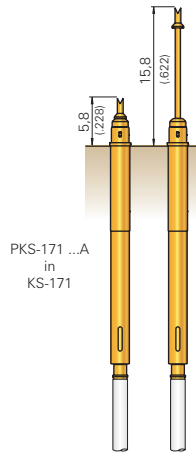
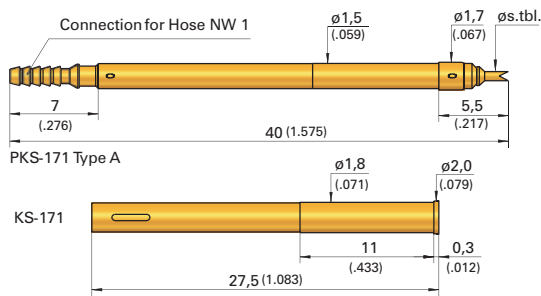

Available tip styles

Material	Tip style	Plating	Further versions	
			∅	∅ (inch)
2	04*	A	∅ 1,00 (.039)	
2	14*	A	∅ 0,50 (.020)	
3	19	A	∅ 1,50 (.059)	
2	91*	A	∅ 1,00 (.039)	

* Diameter of collar: 1,3 mm (.051)

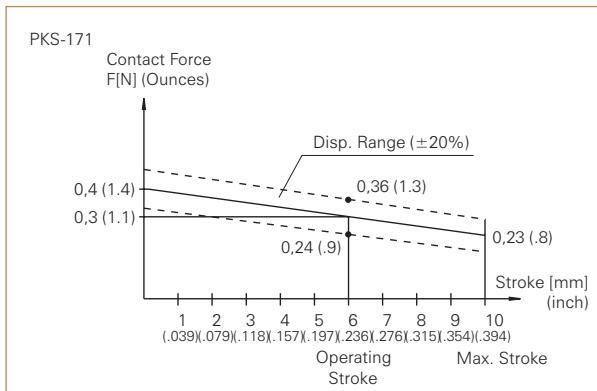

Mechanical data

Switch. path/work. stroke: 6,0 mm (.236)
Maximum stroke: 10,0 mm (.394)
Cont. force at work.stroke: 0,3 N (1.1oz)
Operating medium: Compressed air (filtered, oil-free)
Operating pressure: 6 bar (86 psi)

Electrical data

Current rating: 1 - 2 A
R_i typical: < 30 mΩ

Operating temperature

Standard: 0° up to +80 °C

Materials

Plunger: Steel, gold-plated
Barrel: Brass, gold-plated
Restoring spring: Steel, gold-plated
Receptacle: Brass, gold-plated
O-rings: Perbunan

Mounting hole size

with receptacle KS-171:
 ∅ 1,79 - 1,80 mm (.0705 - .0709)
without receptacle: ∅ 1,49 mm (.0587)

Warning:

Do not solder the cable to the crimp points of the receptacle.

Note:

The assembly in grid size 1,91 mm (75 Mil) is only possible up to a double row, and then only without use of receptacles.

Note:

The receptacles can be used from grid size 2,54 mm (100 Mil) upwards.

Ordering example

Series	Tip material 2 = Steel 3 = BeCu	Tip style	Tip diameter (1/100 mm)	Plating A = Gold	Spring force (dN)	Collar height (mm)	Type "A"
PKS	1	7	1	2	0	4	1
0	0	0	0	A	0	3	0
2	0	2	0	A	0	2	A
Receptacle: KS - 171							

Test probe:

Receptacle:

PKS 200

Pneumatic Test Probes

Grid:

≥ 2,54 mm

≥ 100 Mil

Installation height with KS: 5,9 mm (.232)

Recommended stroke: 6,0 mm (.236)

Mounting and functional dimensions

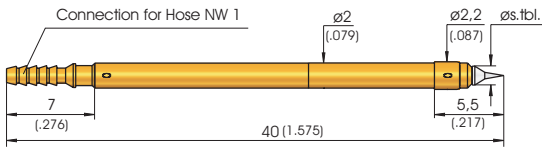

PKS-200 Type A

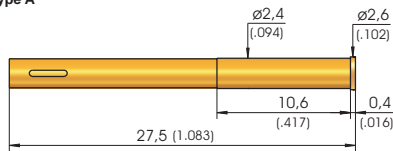

KS-200

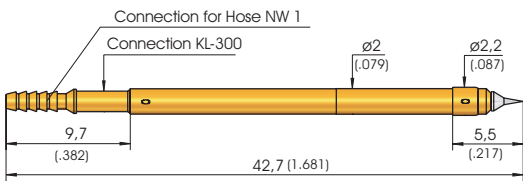

PKS-200 Type B

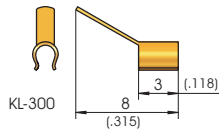

PKS-200

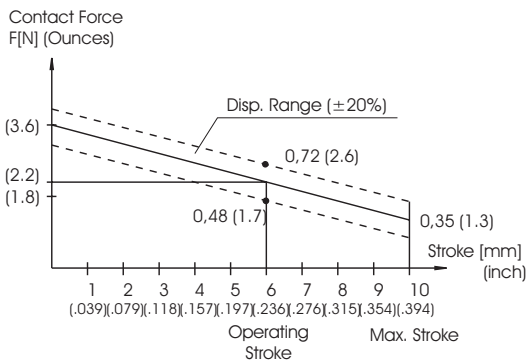

Mechanical data

Working stroke: 6,0 mm (.236)
Maximum stroke: 10,0 mm (.394)
Cont. force at work.stroke: 0,6 N (2.2oz)
Operating medium: Compressed air (filtered, oil-free)
Operating pressure: 6 bar (86 psi)

Electrical data

Current data: 1 - 2 A
R_i typical: < 30 mΩ

Operating temperature

Standard: 0° up to +80 °C

Materials

Plunger: Steel, rhodium- or gold-plated
Barrel: Brass, gold-plated
Restoring spring: Steel, gold-plated
Receptacle: Brass, gold-plated
O-rings: Perbunan

Mounting hole size

with receptacle: ø 2,38 - 2,39 mm (.0937 - .0941)
without receptacle: ø 2,00 mm (.0787)

Available tip styles

Material	Tip style	Plating	Further versions	
			ø	ø (inch)
2 01 ***		R	ø 1,50 (.059)	
2 04 **		R	ø 1,30 (.051)	
2 06 **		A	ø 1,00 (.039)	
2 33 **		A	ø 1,30 (.051)	
2 91 *		A	ø 1,00 (.039)	

Collar diameter:

* = 1,20 mm (.047)

*** = 1,50 mm (.059)

** = 1,30 mm (.051)

**** = 1,80 mm (.071)

Warning:

Do not solder the cable to the crimp points of the receptacle.

Note:

The assembly in grid size 2,54 mm (100 Mil) is only possible up to a double row, and then only without use of receptacles and KL-300. Then prewired PKS-200 ... V (with flexible wire AWG 34, length 500 mm (20.000")) must be used. Minimal recommended bending radius: 10 mm (.394).

Note:

The receptacles and KL-300 can be used from grid 3,00 mm (120 Mil) up.

Note:

Pneumatic accessories and general instructions shown on page 174.

Ordering example

Series	Tip material	Tip style	Tip diameter (1/100 mm)	Plating	Spring force (dN)	Collar height (mm)	Type (alternative B or V)
2 = Steel				A = Gold R = Rhodium			

Test probe:

PKS 200 2 01 150 R 06 02 A

Receptacle:

KS - 200

Clip connection with solder terminal for series 200:

KL - 300

Grid:
 ≥ 2,54 mm
 ≥ 100 Mil

Installation height with KS: 5,9 mm (.232)
 Recommended stroke: 6,0 mm (.236)

Mounting and functional dimensions

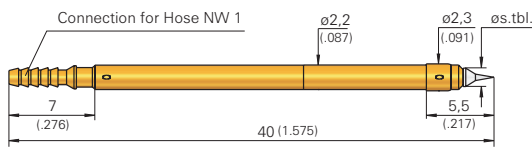

PKS-220 Type A

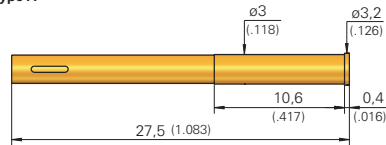

KS-220

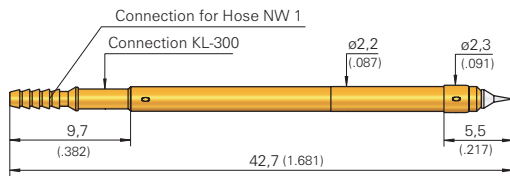

PKS-220 Type B

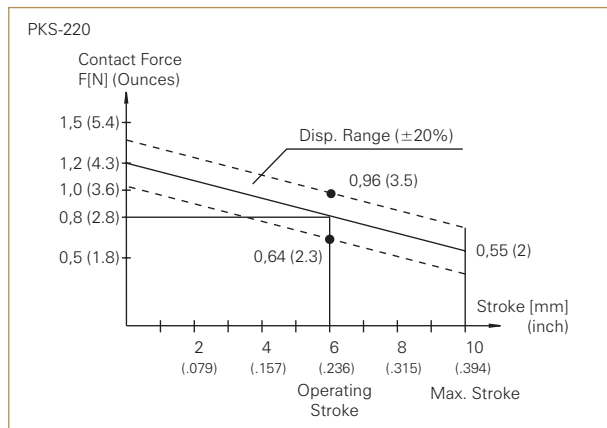
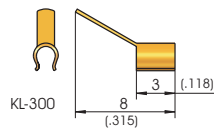

Mechanical data

Working stroke: 6,0 mm (.236)
Maximum stroke: 10,0 mm (.394)
Cont. force at work.stroke: 0,8 N (2.9oz)
Operating medium: Compressed air (filtered, oil-free)
Operating pressure: 6 bar (86 psi)

Electrical data

Current data: 2 - 3 A
R_i typical: < 30 mΩ

Operating temperature

Standard: 0° up to +80 °C

Materials

Plunger: Steel or BeCu, rhodium- or gold-plated
Barrel: Brass, gold-plated
Restoring spring: Steel, gold-plated
Receptacle: Brass, gold-plated
O-rings: Perbunan

Mounting hole size

with receptacle: ø 2,98 - 2,99 mm (.1173 - .1177)
without receptacle: ø 2,20 mm (.0866)

Available tip styles

Material	Tip style	Plating	Further versions	
			ø	ø (inch)
2 01 **		R	ø 1,50 (.059)	
3 03		R	ø 2,00 (.079)	
2 04 *		R	ø 1,30 (.051)	
2 05 ***		A	ø 1,00 (.039)	
2 06		A	ø 2,50 (.098)	
3 06		R	ø 2,00 (.079)	
2 07		R	ø 2,00 (.079)	
2 91 ** **		N	ø 1,00 (.039)	

Collar diameter:

* = 2,00 mm (.079) ** = 1,50 mm (.059)
 *** = 1,30 mm (.051) **** = 1,20 mm (.047)

Warning:

Do not solder the cable to the crimp points of the receptacle.

Note:

The assembly in grid size 2,54 mm (100 Mil) is only possible up to a double row, and then only without use of receptacles and KL-300. The receptacle and KL-300 can be used from grid size 3,5 mm (140 Mil) upwards.

Note:

Pneumatic accessories and general instructions shown on page 174.

Ordering example

Series	Tip material	Tip style	Tip diameter (1/100 mm)	Plating	Spring force (dN)	Collar height (mm)	Type (alternative B)
2	2 = Steel	01	150	A = Gold	08	02	A
3	3 = BeCu			R = Rhodium			

Test probe:

PKS 220 2 01 150 R 08 02 A

Receptacle:

KS - 220

Clip connection with solder terminal for Series 220:

KL - 300

PKS 299

Pneumatic Test Probes

Grid:

≥ 3,50 mm

≥ 140 Mil

Installation height with KS: 5,9 mm (.232)

Recommended stroke: 12,0 mm (.472)

Mounting and functional dimensions

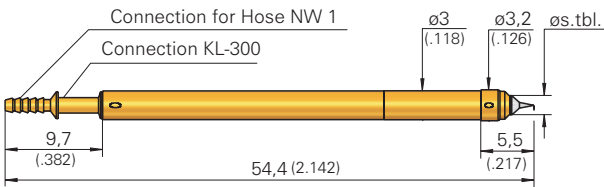

PKS-299 Type B

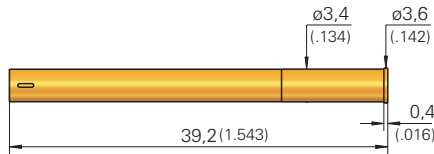

KS-299

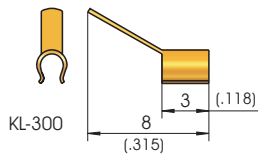

KL-300

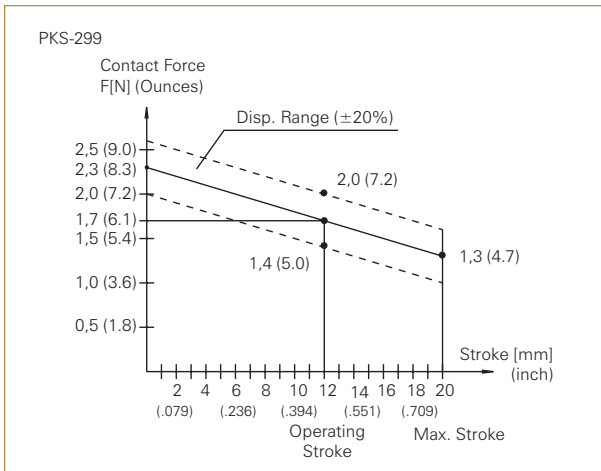

Mechanical data

Working stroke: 12,0 mm (.472)

Maximum stroke: 20,0 mm (.787)

Cont. force at work.stroke: 1,7 N (6.1oz)

Operating medium: Compressed air (filtered, oil-free)

Operating pressure: 6 bar (86 psi)

Electrical data

Current rating: 2 - 3 A

10 A (Type "BH", see Note below)

R_i typical: < 30 mΩ

Operating temperature

Standard: 0° up to +80 °C

Materials

Plunger: Steel or BeCu,

rhodium- or gold-plated

Barrel: Brass, gold-plated

Restoring spring: Steel, gold-plated

Receptacle: Brass, gold-plated

O-rings: Perbunan

Mounting hole size

with receptacle: ø 3,38 - 3,39 mm

(.1331 - .1335)

without receptacle: ø 3,00 mm (.1181)

Available tip styles

Material	Tip style	Plating	Further versions	
			ø	ø (inch)
2	01**	R		
3	02	A		
2	04**	R	2,00	(.079)
2	15*	A		

* pressed-in HM-tip, installation height 6,5 mm (.256)

** Collar diameter: 2,0 mm (.079)

Available tip styles

Special versions without collar

Material	Tip style	Plating	Further versions	
			ø	ø (inch)
2	01***	R		
2	04***	R		
3	05***	A		

*** Shaft diameter: 1,50 mm (.059)

Warning:

Do not solder the cable to the crimp points of the receptacle.

Note:

For high current applications up to 10 A, order with special designation "BH" (terminal "B").

Note:

The receptacle can be used from grid size 4,00 mm (160 Mil) upwards.

Note:

Pneumatic accessories and general instructions shown on page 174.

Ordering example

	Series	Tip material 2 = Steel 3 = BeCu	Tip style	Tip diameter (1/100 mm)	Plating A = Gold R = Rhodium	Spring force (dN)	Collar height (mm)	Type (alternative "B" or "BH")
Test probe:	PKS	2	01	2	R	17	02	B
Test probe for use up to 10 A:	PKS	2	04	130	R	17	02	BH
Receptacle:	KS	299						
Clip connection with solder terminal:	KL	300						

Grid:
 ≥ 3,50 mm
 ≥ 140 Mil

Installation height with KS: 5,9 mm (.232)
 Recommended stroke: 6,0 mm (.236)

Mounting and functional dimensions

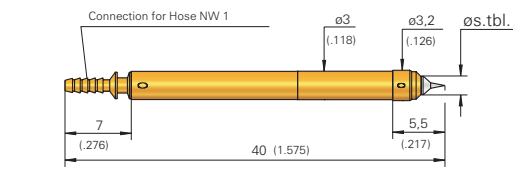

PKS-300 Type A

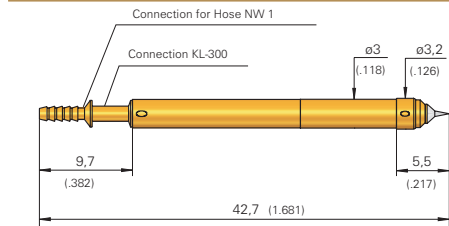
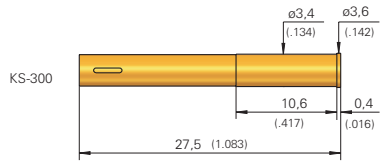

PKS-300 Type B

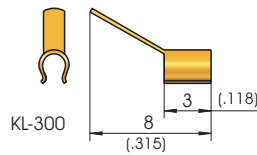

KL-300

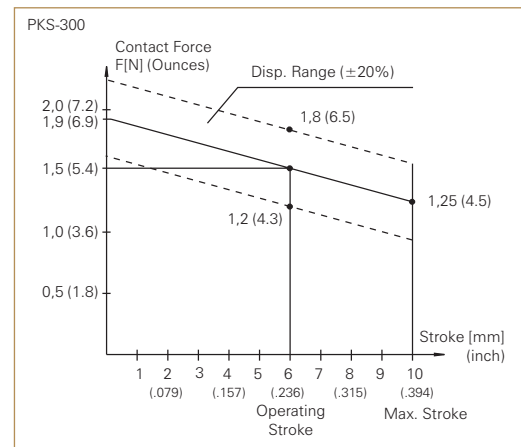

Mechanical data

Working stroke: 6,0 mm (.236)
Maximum stroke: 10,0 mm (.394)
Contact force at work.stroke: 1,1 N (4.0oz) or 1,5 N (5.4oz)
Operating medium: Compressed air (filtered, oil-free)
Operating pressure: 6 bar (86 psi)

Electrical data

Current rating: 2 - 3 A
 10 A (Type "AH" oder "BH", see Note below)
R_i typisch: < 30 mΩ

Operating temperature

Standard: 0° up to +80 °C

Materials

Plunger: Steel, rhodium- or gold-plated
Barrel: Brass, gold-plated
Restoring spring: Steel, gold-plated
Receptacle: Brass, gold-plated
O-rings: Perbunan

Mounting hole size

with receptacle: ø 3,38 - 3,39 mm (.1331 - .1335)
without receptacle: ø 3,00 mm (.1181)

Available tip styles

Material	Tip style	Plating	Further versions	
			ø	ø (inch)
2	01	R	ø 2,00 (.079)	
2	04 **	R	ø 1,30 (.051)	2,00 (.079)
2	05	R	ø 2,50 (.098)	1,30 ** (.051)
2	06 **	A	ø 1,30 (.051)	2,50 (.098) 3,50 (.138)
2	15 *	A	ø 2,00 (.079)	
2	33 **	A	ø 1,30 (.051)	
2	91 **	A	ø 1,30 (.051)	

* pressed-in HM-tip, installation height 6,5 mm (.256)
 ** Collar diameter: 2,0 mm (.079)

Warning:

Do not solder the cable to the crimp points of the receptacle.

Note:

For high current applications up to 10 A, order with special designation "AH" (terminal "A") resp. "BH" (terminal "B").

Note:

The receptacle can be used from grid size 4,00 mm (160 Mil) upwards.

Note:

Pneumatic accessories and general instructions shown on page 174.

*** Note:

Tip 15, 01, 91 F = 1,1 N (4.0oz)
 Tip 04, 05, 06, 33 F = 1,5 N (5.4oz)

Ordering example

	Series	Tip material 2 = Steel	Tip style	Tip diameter (1/100 mm)	Plating A = Gold R = Rhodium	Spring force (dN)	Collar height (mm)	Type (alternative "A", "AH", "B", "BH")
Test probe:	PKS	300	2	01	200	R	11	02 A
Test probe for use up to 10 A:	PKS	300	2	06	130	A	15	02 AH
Receptacle:	KS	300						
Clip connection with solder terminal for series 300:	KL	300						

PKS 399

Pneumatic Test Probes

Grid:

≥ 4,50 mm

≥ 177 Mil

Installation height with KS: 5,9 mm (.232)

Recommended stroke: 12,0 mm (.472)

Mounting and functional dimensions

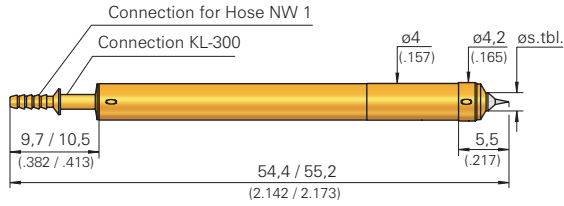

PKS-399 Type 1: with Connection for Hose NW 1

PKS-399 Type 2: with Connection for Hose NW2 (lengths see 2nd value)

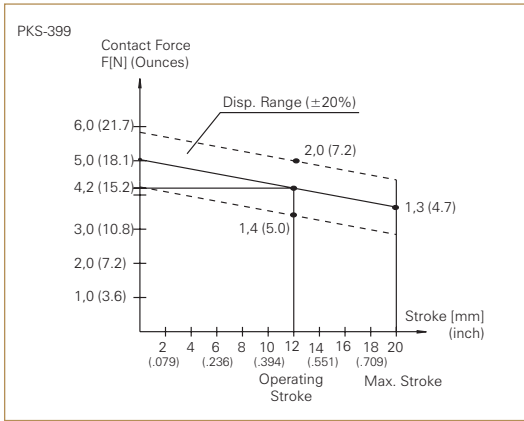
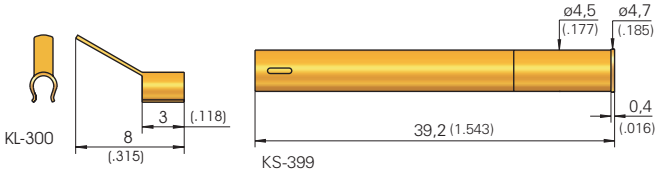

Mechanical data

Working stroke: 12,0 mm (.472)
Maximum stroke: 20,0 mm (.787)
Cont. force at work.stroke: 3,7 N (13.4oz) or 4,2 N (15.2oz)***
Operating medium: Compressed air (filtered, oil-free)
Operating pressure: 6 bar (86 psi)

Electrical data

Current rating: 2 - 3 A
 10 A (Type "1H" or "2H", see Note below)
R_i typisch: < 30 mΩ

Operating temperature

Standard: 0° up to +80 °C

Materials

Plunger: Steel or BeCu, rhodium- or gold-plated
Barrel: Brass, gold-plated
Restoring spring: Steel, gold-plated
Receptacle: Brass, gold-plated
O-rings: Perbunan

Mounting hole size

with receptacle: ø 4,48 - 4,49 mm (.1764 - .1768)
without receptacle: ø 4,00 mm (.1575)

Available tip styles

Material	Tip style	Plating	Further versions	
			ø	ø (inch)
2	01	R	ø 2,00 (.079)	
3	02	A	ø 2,50 (.098)	
2	04**	R	ø 1,30 (.051)	2,00 (.079)
2	15*	A	ø 2,00 (.079)	

* pressed-in HM-tip, installation height 6,5 mm (.256)

** collar diameter: 2,0 mm (.079)

Available tip styles

special versions without collar

Material	Tip style	Plating	Further versions	
			ø	ø (inch)
2	01***	R	ø 1,50 (.059)	
2	04***	R	ø 1,50 (.059)	
3	05***	A	ø 1,30 (.051)	

*** shaft diameter: 1,50 mm (.059)

*** Note:

Tip 01, 15 F = 3,7 N (13.4oz)
 Tip 02, 04, 05 F = 4,2 N (15.2oz)

Warning:

Do not solder the cable to the crimp points of the receptacle.

Note:

For high current applications up to 10 A, order with special designation "1H" (terminal "1") resp. "2H" (terminal "2").

Note:

The receptacle can be used from grid size 5,08 mm (200 Mil) upwards.

Note:

Pneumatic accessories and general instructions shown on page 174.

Ordering example

	Series	Tip material 2 = Steel	Tip style	Tip diameter (1/100 mm)	Plating A = Gold R = Rhodium	Spring force (dN)	Collar height (mm)	Type (alternative "1", "1H", "2", "2H")
Test probe:	PKS	399	201	200	R	37	02	1
Test probe for use up to 10 A:	PKS	399	204	130	R	42	02	1H
Receptacle:	KS	399						
Clip connection with solder terminal for type 1:	KL	300						

Grid:
 ≥ 4,50 mm
 ≥ 177 Mil
Installation height with KS: 5,9 mm (.232)
Recommended stroke: 6,0 mm (.236)

Mounting and functional dimensions

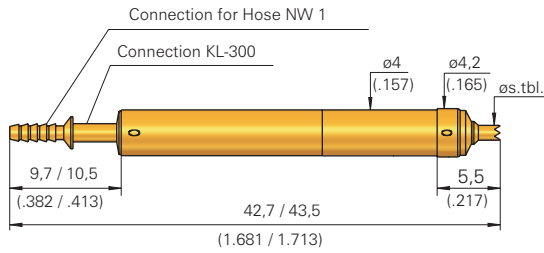

PKS-420 Type 1: with Connection for Hose NW 1
 PKS-420 Type 2: with Connection for Hose NW2 (lengths see 2nd value)

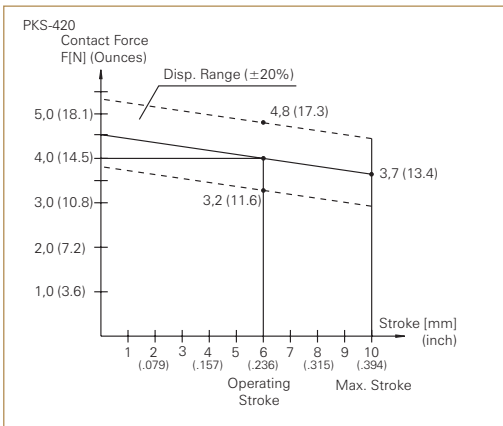
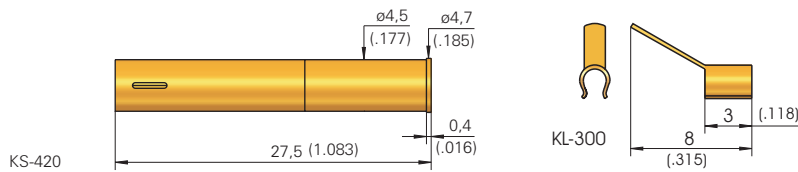

Mechanical data
Working stroke: 6,0 mm (.236)
Maximum stroke: 10,0 mm (.394)
Cont. force at work.stroke: 3,7 N (13.4oz) or 4,2 N (15.2oz)***
Operating medium: Compressed air (filtered, oil-free)
Operating pressure: 6 bar (86 psi)

Electrical data
Current rating: 2 - 3 A
 10 A (Type "1H" or "2H", see Note below)
R_i typisch: < 30 mΩ

Operating temperature
Standard: 0° up to +80 °C

Materials
Plunger: Steel, rhodium- or gold-plated
Barrel: Brass, gold-plated
Restoring spring: Steel, gold-plated
Receptacle: Brass, gold-plated
O-rings: Perbunan

Mounting hole size
with receptacle: ø 4,48 - 4,49 mm (.1764 - .1768)
without receptacle: ø 4,00 mm (.1575)

		Available tip styles			
Material	Tip style	Tip diameter	Plating	Further versions	
				ø	ø (inch)
2	01	ø 2,00 (.079)	R		
2	04**	ø 1,30 (.051)	R	2,00	(.079)
2	05	ø 2,50 (.098)	R	1,30**	(.051)
2	06**	ø 1,30 (.051)	A	2,50	(.098)
2	15*	ø 2,00 (.079)	A		
2	33**	ø 1,30 (.051)	A		
2	91**	ø 1,30 (.051)	A		

* pressed-in HM-tip, installation height 6,5 mm (.256)
 ** collar diameter: 2,0 mm (.079)

Warning:
 Do not solder the cable to the crimp points of the receptacle.

Note:
 For high current applications up to 10 A, order with special designation "1H" (terminal "1") resp. "2H" (terminal "2").

Note:
 The receptacle can be used from grid size 5,08 mm (200 Mil) upwards.

Note:
 Pneumatic accessories and general instructions shown on page 174.

***** Note:**
 Tip 15, 01, 91 F = 3,7 N (13.4oz)
 Tip 04, 05, 06, 33 F = 4,2 N (15.2oz)

Ordering example

	Series	Tip material 2 = Steel	Tip style	Tip diameter (1/100 mm)	Plating A = Gold R = Rhodium	Spring force (dN)	Collar height (mm)	Type (alternative "1", "1H", "2", "2H")
Test probe:	PKS	4	20	2	06	130	A	42021
Test probe for use up to 10 A:	PKS	4	20	2	04	130	R	42021H
Receptacle:	KS	4	20					
Clip connection with solder terminal for type 1:	KL	3	00					

PKS 171 M

Screw-in Pneumatic Test probe

Grid:

≥ 4,50 mm

≥ 180 Mil

Installation height with KS: 5,8 mm (.228)

Recommended stroke: 6,0 mm (.236)

Mounting and functional dimensions

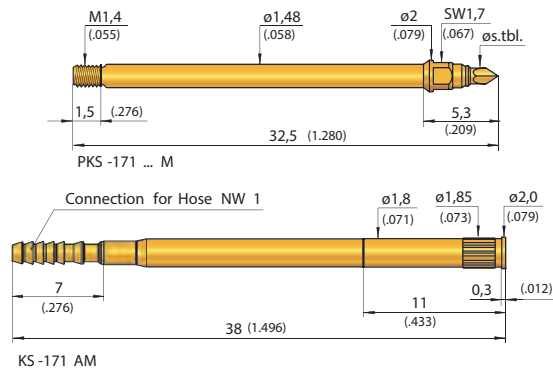

Available tip styles

Material	Tip style	Plating	Further versions	
			∅	∅ (inch)
2	04*	A	∅ 1,00 (.039)	
2	14*	A	∅ 0,50 (.020)	
3	19	A	∅ 1,50 (.059)	
2	91*	A	∅ 1,00 (.039)	

* collar diameter: 1,3 mm (.051)

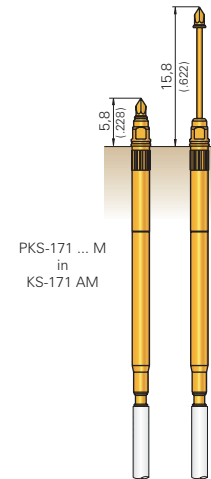
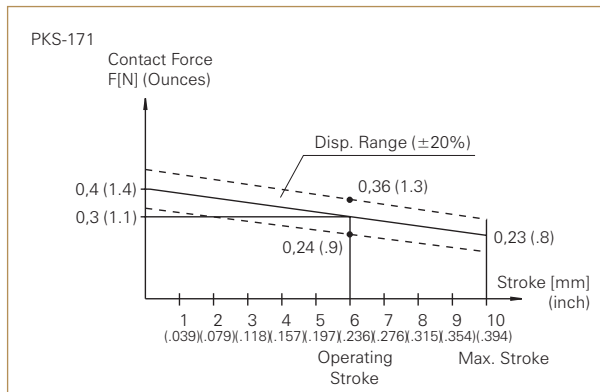

Mechanical data

Switch. path/work. stroke: 6,0 mm (.236)

Maximum stroke: 10,0 mm (.394)

Cont. force at work.stroke: 0,3 N (1.1oz)

Operating medium: Compressed air (filtered, oil-free)

Operating pressure: 6 bar (86 psi)

Materials

Plunger: Steel, gold-plated

Barrel: Brass, gold-plated

Restoring spring: Steel, gold-plated

Receptacle: Brass, gold-plated

O-rings: Perbunan

Warning:

Do not solder the cable to the crimp points of the receptacle.

Recommended screw-in torque:
Min.: 2 cNm / Max.: 3 cNm

Electrical data

Current rating: 1 - 2 A

R_i typical: < 30 mΩ

Mounting hole size

with receptacle KS-171 AM:
∅ 1,80 - 1,82 mm (.0709 - .0717)

Operating temperature

Standard: 0° up to +80 °C

Ordering example

Series	Tip material 2 = Steel 3 = BeCu	Tip style	Tip diameter (1/100 mm)	Plating A = Gold	Spring force (dN)	Collar height (mm)	Type "M"
--------	---------------------------------------	-----------	----------------------------	---------------------	----------------------	-----------------------	-------------

Test probe:

PKS 171 2 04 100 A 03 02 M

Receptacle:

KS - 171 A M

Grid:
 ≥ 3,5 mm
 ≥ 140 Mil

Installation height with KS: 5,7 mm (.224)
 Recommended stroke: 6,0 mm (.236)

Mounting and functional dimensions

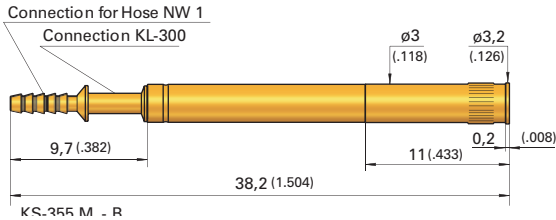
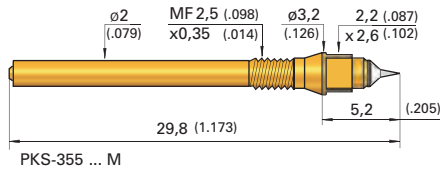

Assembly PKS-355 M with quick-exchange system KS-355 M-B

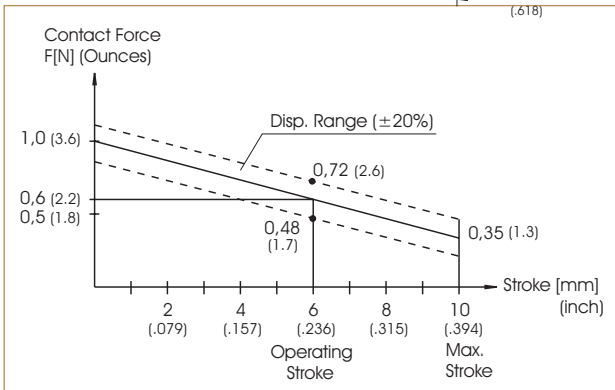
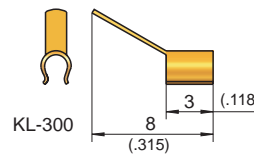
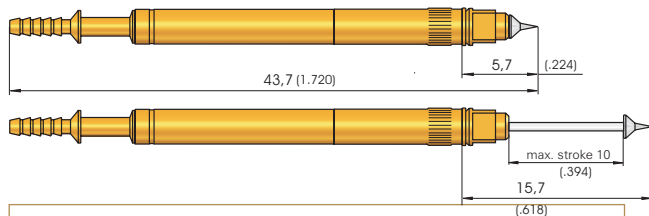

Mechanical data

Working stroke: 6,0 mm (.236)
Maximum stroke: 10,0 mm (.394)
Cont. force at work.stroke: 0,6 N (2.2oz)
Operating medium: Compressed air (filtered, oil-free)
Operating pressure: 6 bar (86 psi)

Materials

Plunger: Steel, rhodium- or gold-plated
Barrel: Brass, gold-plated
Restoring spring: Steel, gold-plated
Receptacle: Brass, gold-plated
O-rings: Perbunan

Electrical data

Current rating: 1 - 2 A
R_i typical: < 30 mΩ

Mounting hole size for Receptacle

in CEM1: ∅ 3,15 - 3,17 mm (.1240-.1248)
in FR4: ∅ 3,17 - 3,18 mm (.1248-.1252)

Operating temperature

Standard: 0° up to +80 °C

Available tip styles

Material	Tip style	Plating	Further versions	
			∅	∅ (inch)
2 01 ***		R	∅ 1,50 (.059)	
2 04 ***		R	∅ 1,30 (.051)	
2 06 **		A	∅ 1,00 (.039)	
2 33 **		A	∅ 1,30 (.051)	
2 91 *		A	∅ 1,00 (.039)	

collar diameter:

* = 1,20 mm (.047)

** = 1,30 mm (.051)

*** = 1,50 mm (.059)

**** = 1,80 mm (.071)

Note:

Electrical and pneumatic connections are performed at the time of customizing only. The exchangeable unit PKS-355 M is screwed into the pre-wired, pneumatically connected KS-355 M-B receptacle. The test probe can be changed from above. The test fixture must not be opened. The wiring and pneumatic connections are not affected.

Note:

Pneumatic accessories and general instructions shown on page 174.

Recommended screw-in torque:
 Min.: 10 cNm / Max.: 20 cNm

Ordering example

Series	Tip material	Tip style	Tip diameter (1/100 mm)	Plating	Spring force (dN)	Collar height (mm)	Type
	2 = Steel			A = Gold R = Rhodium			

Test probe:

PKS 355 2 01 150 R 06 02 M

Receptacle:

KS-355 M-B

Clamp connection with solder terminal for KS-355:

KL-300

PKS 388 M

Screw-in Pneumatic Test Probes

Grid:

≥ 5,08 mm

≥ 200 Mil

Installation height with KS: 6,1 mm (.240)

Recommended stroke: 12,0 mm (.472)

Mounting and functional dimensions

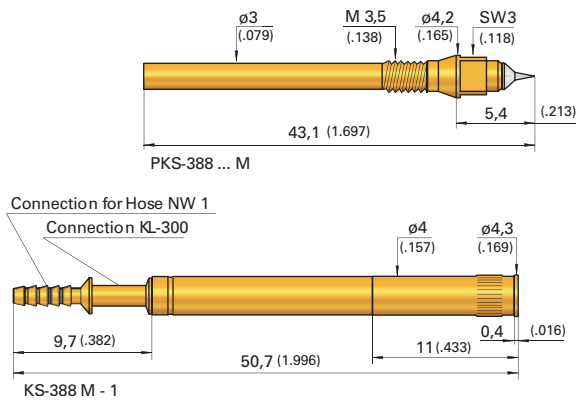

Assembly PKS-388 M with quick-exchange system KS-388 M-1

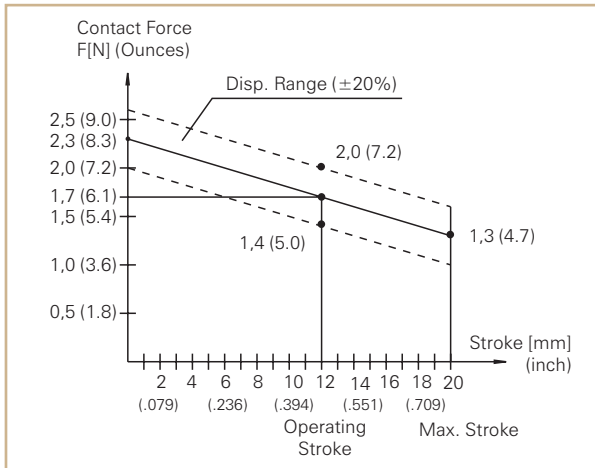
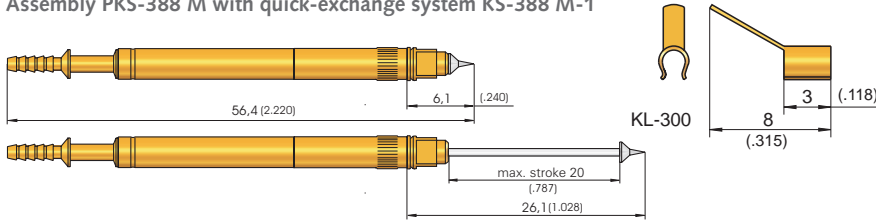

Mechanical data

Working stroke: 12,0 mm (.472)
Maximum stroke: 20,0 mm (.787)
Cont. force at work. stroke: 1,7 N (6.1oz)
Operating medium: Compressed air (filtered, oil-free)
Operating pressure: 6 bar (86 psi)

Materials

Plunger: Steel or BeCu, rhodium- or gold-plated
Barrel: Brass, gold-plated
Restoring spring: Steel, gold-plated
Receptacle: Brass, gold-plated
O-rings: Perbunan

Electrical data

Current rating: 2 - 3 A
 10 A (Type "MH", see note)
R_i typical: < 30 mΩ

Mounting hole size

in CEM1 and FR4: ∅ 4,00 - 4,02 mm (.1575 - .1583)

Operating temperature

Standard: 0° up to +80 °C

Available tip styles

Material	Tip style	Plating	Further versions	
			∅	∅ (inch)
2	01**	R		
3	02	A		
2	04**	R	2,00	(.079)
2	15**	A		

* pressed-in HM-tip, installation height with KS: 7,1 mm (.280)
 ** collar diameter: 2,0 mm (.0799)

Available tip styles

special versions without collar

Material	Tip style	Plating	Further versions	
			∅	∅ (inch)
2	01***	R		
2	04***	R		
3	05***	A		

*** Shaft diameter 1,50 mm (.059)

Note:

For high current applications up to 10 A order with special designation "MH".

Note:

Electrical and pneumatic connections are performed at the time of customising only. The exchangeable unit PKS-355 M is screwed into the pre-wired, pneumatically connected KS-355 M-B receptacle. The test probe can be changed from above. The test fixture must not be opened. The wiring and pneumatic connections are not affected.

Pneumatic accessories and general instructions shown on page 174.

Note - PKS-388 M and KS-388 M-1:

PKS-388 M are screwed into KS-388 M-1 using specialised tools (shown on page 196).

Recommended screw-in torque: Min.: 10 cNm / Max.: 20 cNm

Ordering example

Series	Tip material	Tip style	Tip diameter (1/100 mm)	Plating	Spring force (dN)	Collar height (mm)	Type (alternative "MH")
	2 = Steel 3 = BeCu			A = Gold R = Rhodium			

Test probe:

PKS 388 2 01 2 00 R 17 02 M

Receptacle:

KS - 388 M - 1

Clip connection with solder terminal:

KL - 300

Grid:
 ≥ 3,5 mm
 ≥ 140 Mil

Installation height with KS: 5,7 mm (.224)
 Switch path: 6,0 mm (.236)

Mounting and functional dimensions

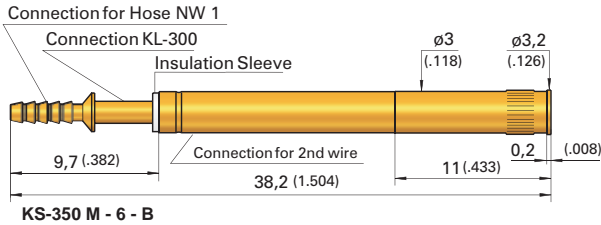
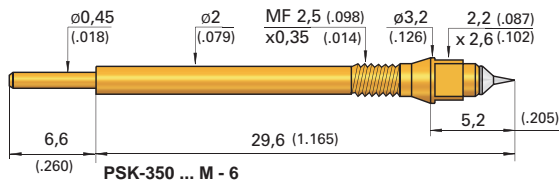

Assembly PSK-350 M with quick-exchange system KS-350 M-6-B

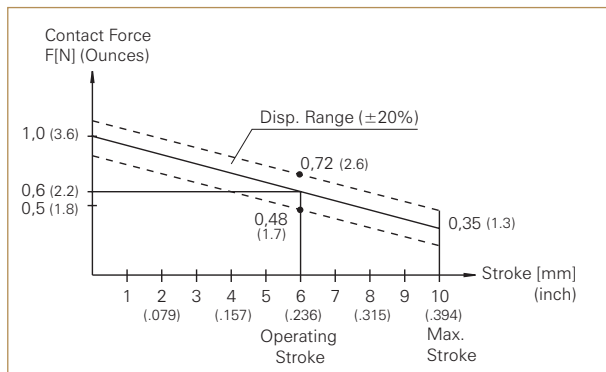
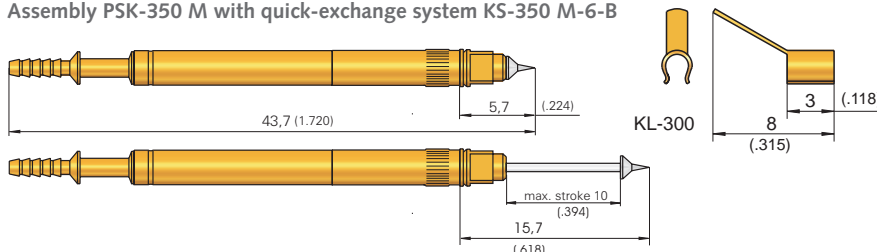

Mechanical data

Switch. path/work. stroke: 6,0 mm (.236)
Maximum stroke: 10,0 mm (.394)
Cont. force at work.stroke: 0,6 N (2.2oz)
Operating medium: Compressed air (filtered, oil-free)
Operating pressure: 6 bar (86 psi)

Electrical data

Current rating: 1 - 2 A
R_i typical: < 30 mΩ

Operating temperature

Standard: 0° up to +80 °C

Materials

Plunger: Steel, rhodium- or gold-plated
Barrel: Brass, gold-plated
Restoring spring: Steel, gold-plated
Receptacle: Brass, gold-plated
O-rings: Perbunan
Insulation: Peek
Terminal: Brass, gold-plated

Mounting hole size for Receptacle

in CEM1: ø 3,15 - 3,17 mm (.1240-.1248)
in FR4: ø 3,17 - 3,18 mm (.1248-.1252)

Available tip styles

Material	Tip style	Tip diameter	Plating	Further versions	
				Ø	Ø (inch)
2	01 ***	Ø 1,50 (.059)	R		
3	02	Ø 2,00 (.079)	A		
2	04 **	Ø 1,30 (.051)	R		
2	06 **	Ø 1,00 (.039)	A		
2	33 **	Ø 1,30 (.051)	A		
2	91 *	Ø 1,00 (.039)	A		

Collar diameter:

* = 1,20 mm (.047) ** = 1,30 mm (.051)
 *** = 1,50 mm (.059) **** = 1,80 mm (.071)

Functionality:

The pneumatic switching probe PSK 350 is designed as an "opener". There is an electric contact between the pneumatic probe and the terminal of the receptacle in the home position. After 6 mm (.236) stroke this connection is interrupted.

Note:

Electrical and pneumatic connections are performed at the time of customising only. The exchangeable unit PKS-355 M is screwed into the pre-wired, pneumatically connected KS-355 M-B receptacle. The test probe can be changed from above. The test fixture must not be opened. The wiring and pneumatic connections are not affected.

Pneumatic accessories and general instructions shown on page 174).

Note - PSK-350 M and KS-350 M-6-B:

PSK-350 M are screwed into KS-350 M-6-B using specialised tools (shown on page 196).

Recommended screw-in torque:
 Min.: 10 cNm / Max.: 20 cNm

Ordering example

Series	Tip material	Tip style	Tip diameter (1/100 mm)	Plating	Spring force (dN)	Collar height (mm)	Type
	2 = Steel 3 = CuBe			A = Gold R = Rhodium			

Test probe:

PSK 350 2 04 130 R 06 02 M-6

Receptacle for PSK-350 ... M-6:

KS-350 M-6-B

Clip-connection with solder terminal for KS-350:

KL-300

Pneumatic test probes can be actuated and controlled individually or in groups.

Example of set-up and layout:

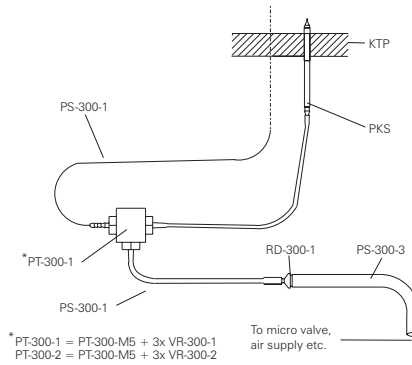
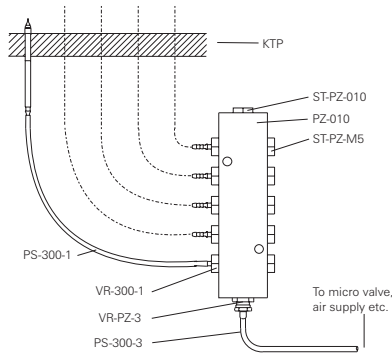

General notes:

A compressed air hose with a standard width of 1 mm (NW1) or 2 mm (NW2) is required to connect pneumatic probes. A range of adapters (see table below) are offered to establish air feed lines from commercially available compressed air hose NW3 or from compressed air distributors with threaded terminals M5.

The hose NW1 should only be used for short distances. The larger diameter of 3 mm guarantees good operating pressure.

The electrical connection is established by first soldering the wire to the KL-300 clip, then fixing the clip onto the end of the pneumatic test probe. (Refer to marked positions in the drawings on the previous data sheets).

To avoid damage to the ends of the hose, only the recommended specialised cutter tool SS-101 should be used

The various connections plates are controlled using micro-valves. Instead of a micro-valve, a sealing plate (DP-1) can be used to seal the air outlet holes.

Item	Tech. designation	Order number
Reducer piece	NW 3 / NW 1	RD-300-1
Reducer piece	NW 1 / NW 2	RD-300-1-2
Reducer piece	NW 3 / NW 2	RD-300-2
Threaded terminal	M 5 / NW 1	VR-300-1
Threaded terminal	M 5 / NW 2	VR-300-2
Threaded terminal	M 5 / NW 3	VR-300-3
Threaded terminal	M 3 / NW 1	VR-200-1
Threaded terminal	M 3 / NW 2	VR-200-2
Threaded terminal	M 3 / NW 3	VR-200-3
T-Piece (without threaded terminal)	3 x M 5	PT-300-M5
T-Piece incl. 3 x VR-300-1	3 x NW 1	PT-300-1
T-Piece incl. 3 x VR-300-2	3 x NW 2	PT-300-2
Ten-fold distributor	10 x M 5	PZ-010
Compressed-air hose, Ø _i 1,2; Ø _o 2,0	NW 1	PS-300-1
Compressed-air hose, Ø _i 2,0; Ø _o 3,9	NW 2	PS-300-2
Compressed-air hose, Ø _i 2,6; Ø _o 4,0	NW 3	PS-300-3
Specialised cutting tool		SS-010
Dummy plug for distributor	B1/8	ST-PZ-010
Dummy plug for distributor	M 5	ST-PZ-M 5
Plug for distributor	M 5-1/8a	ST-PZ-VR
Terminal for hose NW 3	NM 5-PK 3	VR-PZ-3
Terminal for hose NW 4	NM 5-PK 4	VR-PZ-4
3/2 Micro-valve 12V (0,95 W)		MV 12
3/2 Micro-valve 24V (0,95 W)		MV 24
Single-connection plate	for 1 valve	ASP-1
Multi-connection plate	for 2-10 Valves	ASP-X
Sealing plate	for conn. plate	DP-1
Silencer	M3	28574
Silencer	M5	3981

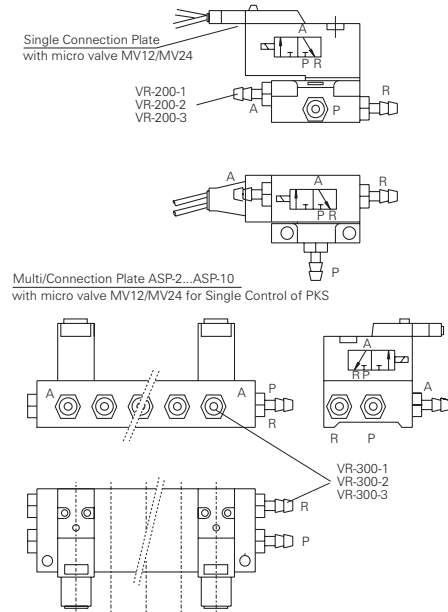

Ordering examples to activate and control 5 PKS-300

Simultaneously activation and control	Separate activation and control	Item	Order number
5	5	Pneumatic test probes	PKS-300 xxx xxx x xx02 x
x meter	x meter	Compressed-air hose NW 1	PS-300-1
1	-	Ten-fold distributor	PZ-010
1	-	Dummy plug	ST-PZ-010
1	1	Terminal for hose NW 3	VR-PZ-3
5	5	Terminal for hose NW 1	VR-300-1
x meter	-	Compressed-air hose NW 3	PS-300-3
1	5	Microvalve 24V or 12V(incl. plug)	MV 24 / MV 12
1	-	Single-connection plate for microvalve	ASP-1
-	1	Single-connection plate for microvalve	ASP-5
2	-	Terminal for hose NW 3	VR-200-3
5	2	Dummy plug for distributor	ST-PZ-M5
-	1	Terminal for hose NW 3	VR-300-3
-	1	Silencer	3981

Single Connection Plate (ASP-1)

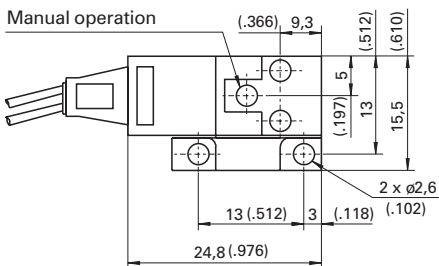
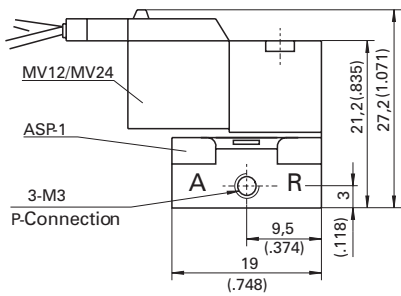

Multi Connection Plate (ASP-2...-10)

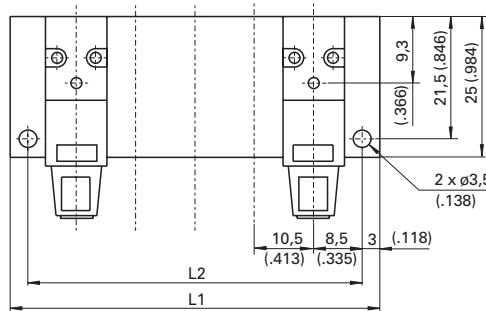
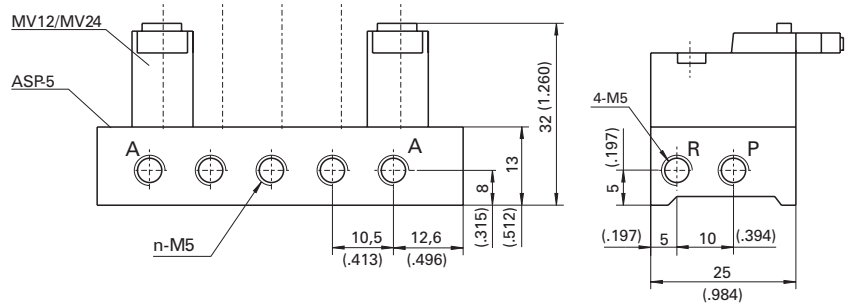
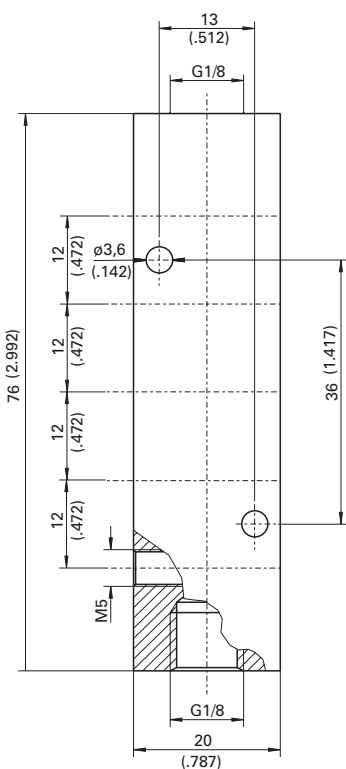
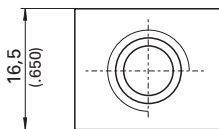

Table of Dimensions for Multi Connection Plate

Number Valves	L1	L2
2	33,5 (1.319)	27,5 (1.083)
3	44,0 (1.732)	38,0 (1.496)
4	54,5 (2.146)	48,5 (1.909)
5	65,0 (2.559)	59,0 (2.323)
7	86,0 (3.386)	80,0 (3.150)
8	96,0 (3.780)	90,5 (3.563)
9	107,0 (4.213)	101,0 (3.976)
10	117,5 (4.626)	111,5 (4.390)

Ten-fold distributors (PZ-010)



T-piece (PT-300-M5)

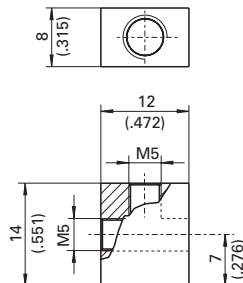

Threaded Terminal M3	Threaded Terminal M5	Reducers	Plugs for Distributors PZ-010
 VR-200-1 (.394)	 VR-300-1 (.512)	 RD-300-1 (.453)	 ST-PZ-VR (.374)
 VR-200-2 (.402)	 VR-300-2 (.492)	 RD-300-1-2 (.571)	 VR-PZ-3 (.850)
 VR-200-3 (.433)	 VR-300-3 (.630)	 RD-300-2 (.669)	 VR-PZ-4 (.976)

Assorted Test Probes

Short-stroke GKS / Charging and Transfer Probes

Solderable GKS

Spring-loaded test probes can be used directly in assemblies or on PC boards in addition to classic test purposes. Therefore, INGUN probes can be used for a wide variety of test applications.

Short stroke GKS are often used as charging and transfer probes in battery chargers. The test probes stand out due to their extremely compact design, as well as a low installation height in combination with a high spring force.

Solderable GKS are soldered directly into PC boards without the need for receptacles. These probes can be used in similar applications as the short stroke probes, for example, current transfer within an assembly

Assorted applications of assorted test probes

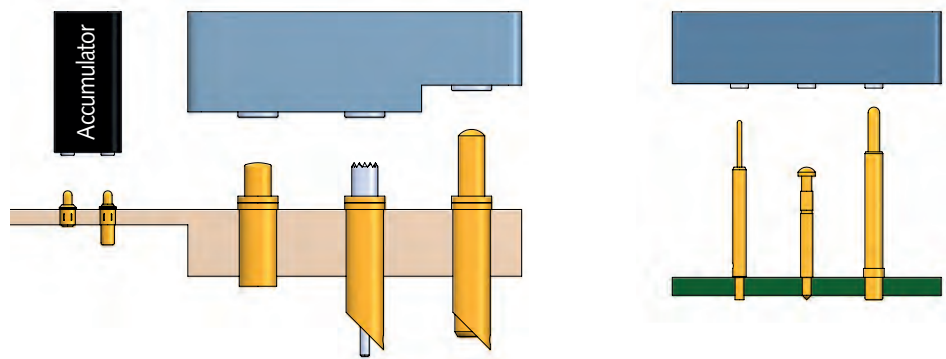

Test probe as contact element

Test probe soldered directly on PCB

Grid size / series	Short stroke test probes charge and transfer	Solderable test probes
≥ 1.91 mm (≥ 75 Mil)	GKS-961	GKS-941
≥ 2.54 mm (≥ 100 Mil)	GKS-761 M	GKS-064 GKS-986
≥ 3.00 mm (≥ 120 Mil)	GKS-967 GKS-970	-
≥ 4.00 mm (≥ 160 Mil)	GKS-967 M	-
≥ 6.50 mm (≥ 260 Mil)	GKS-364 GKS-365 GKS-366	-
Page(s)	179 - 184	185

Short stroke and solderable GKS

These test probes are commonly used to supply signal and current of electronic devices and enable a quick assembly exchange during maintenance.

Thereby the test probes have a variety of advantages

- Height and tolerance compensation
- Compensation of unevenness and parallelism errors
- Can withstand impacts and vibrations
- Minimal installation space required
- High conductivity
- Excellent chemical resistance
- Outstanding durability

The short stroke probes can also be installed with a receptacle to enable easy exchange. Due to the extremely short design, exchange solutions for probes installed directly on the PC board can also be realised without difficulty.

Solderable GKS are soldered directly into PC boards without the need for receptacles. Care should be taken to ensure the test probe does not overheat during the soldering process, in order to avoid damage to the spring.

Note: The GKS-967...G probe can also be soldered directly into PC boards without a receptacle. This is made possible by its closed barrel, which ensures solder cannot penetrate the probe.

For quick, reliable assembly of PC boards, it is possible to pack the test probes in assembly belts. This enables the automatic feeding of parts in the pick & place machine.

Contact us if you would like further information about assembly belts.

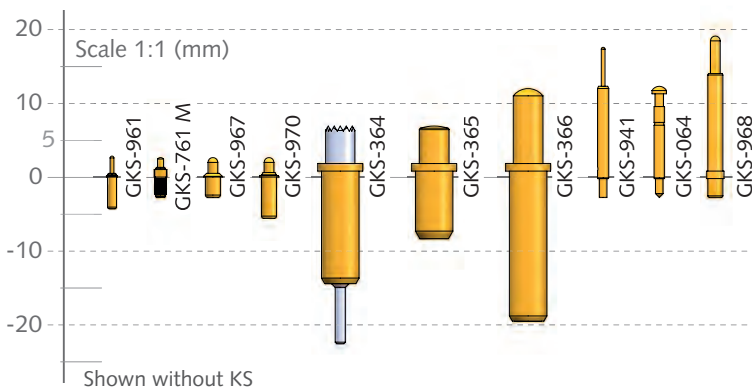

Assorted Test Probes

Short stroke Test Probes Charge and transfer

GKS-961	179
GKS-761 M	180
GKS-967/967 M	181
GKS-970	182
GKS-364	183
GKS-365	184
GKS-366	184

Solderable Test Probes

GKS-941	185
GKS-064	185
GKS-986	185

Note:

See next page for overview and comparison table.

Assorted Test Probes

Overview and Comparison

Test probe version	Series	Grid size (≥ mm)	Working stroke (mm)	Max. stroke (mm)	Current rating (A)	Spring forces (N)		Installation height with KS (mm)	Shortest probe (mm)	Page
						min	max			
Short stroke test probes charge and transfer	GKS-961	1.91	1	1.3	2	0.6	-	3	7	179
	GKS-761 M	2.54	1	1.2	5	1	-	2.8	5.3	180
	GKS-967	3	1	1.2	5 – 8	1	2	2.8/4.3	5.1	181
	GKS-970	3	1.0/2.8	1.7/3.3	5 – 8	1	2	2.8/5.3	8.1/10.6	182
	GKS-967 M	4	1	1.2	5 – 8	1	2	3.1	5.3	181
	GKS-365	6.5	3.2	4	5 – 8	0.6	8	7	15	184
	GKS-364	6.5	4	5	5 – 20	0.6	8	7	29	183
GKS-366	6.5	8	10	5 – 8	1.5	16	12	31	184	
Solderable test probes	GKS-941	1.91	3.2	4	5 – 8	0.8	3.5	17.5	20	185
	GKS-064	2.54	1.4	1.7	5 – 8	0.2	0.6	12.3	14.8	185
	GKS-986	2.54	3	5	5 – 8	1	-	19	21.5	185

Grid:
 ≥ 1,91 mm
 ≥ 75 Mil

Installation height with KS: 3,0 mm (.118)
Recommended stroke: 1,0 mm (.039)

Mounting and functional dimensions

Available tip styles				
Material	Tip style	Plating	Further versions	
			∅	∅ (inch)
3	05 	A	∅ 0,50 (.020)	

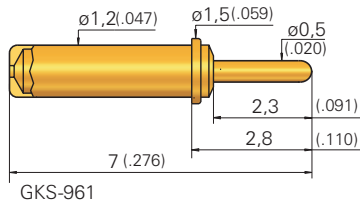

GKS-961

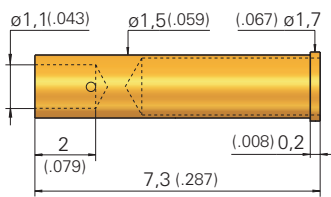

KS-961 35

Mechanical data

Working stroke: 1,0 mm (.039)
Maximum stroke: 1,3 mm (.051)
Spring force at work. stroke: 0,6 N (2.2oz)

Materials

Plunger: BeCu, gold-plated
Barrel: Brass, gold-plated
Spring: Stainless steel, gold-plated
Receptacle: Brass, gold-plated

Electrical data

Current rating: 2 A
R_i typical: < 100 mΩ

Mounting hole size

in CEM1 and FR4 with receptacle: ∅ 1,49 - 1,50 mm (.0587 - .0591)
without receptacle: ∅ 1,2 mm (.0472)

Operating temperature

Standard: -100° up to +200° C

Ordering example

Series	Tip material 2 = Steel 3 = BeCu	Tip style	Tip diameter (1/100 mm)	Plating A = Gold	Spring force (dN)	Collar height (mm)
--------	---------------------------------------	-----------	----------------------------	---------------------	----------------------	-----------------------

Test probe:

G K S 9 6 1 3 0 5 0 5 0 A 0 6 0 1

Receptacles:

K S - 9 6 1 3 5

GKS 761 M

Short-stroke and Charging Test Probes

Grid:

≥ 2,54 mm

≥ 100 Mil

Installation height with KS: 2,8 mm (.110)

Recommended stroke: 1,0 mm (.039)

Mounting and functional dimensions

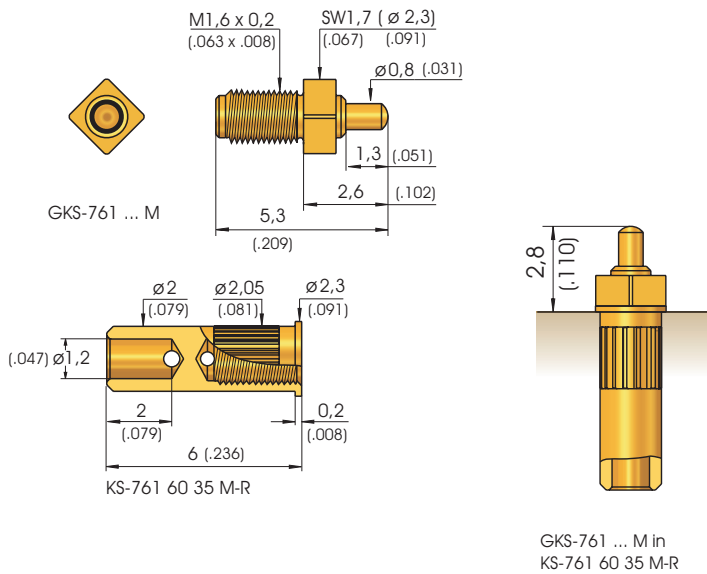

Available tip styles

Material	Tip style	Plating	Further versions	
			∅	∅ (inch)
ω	05		∅ 0,80 (.032)	A

Mechanical data

Working stroke: 1,0 mm (.039)

Maximum stroke: 1,2 mm (.047)

Spring force at work. stroke: 1,0 N (3.6oz)

Electrical data

Current rating: 5 A

R_i typical: < 20 mΩ

Operating temperature

Standard: -40° up to +80° C

Materials

Plunger: BeCu, gold-plated

Barrel: Brass, gold-plated

Spring: Steel, gold-plated

Receptacle: Brass, gold-plated

Mounting hole size

in CEM1 and FR4
with KS-761 60 35 M-R ∅ 2,00 - 2,02 mm (.0787 - .0866)

Recommended screw-in torque:
Min.: 3 cNm / Max.: 5 cNm

Ordering example

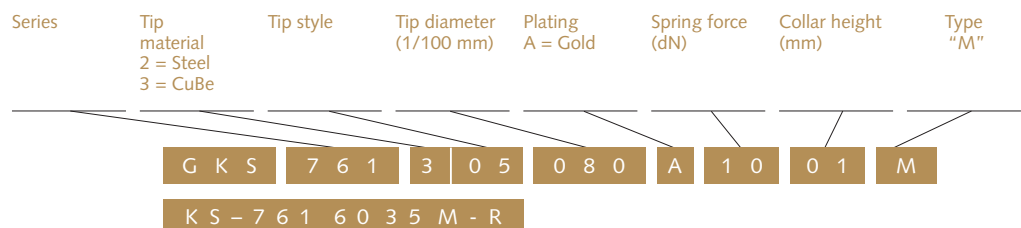

Test probe:

Receptacle:

Grid:
 ≥ 3,00 mm
 ≥ 120 Mil

Installation height with KS: 2,8 / 3,1 / 4,3 mm (.110/.122/.169)
Recommended stroke: 1,0 mm (.039)

Mounting and functional dimensions

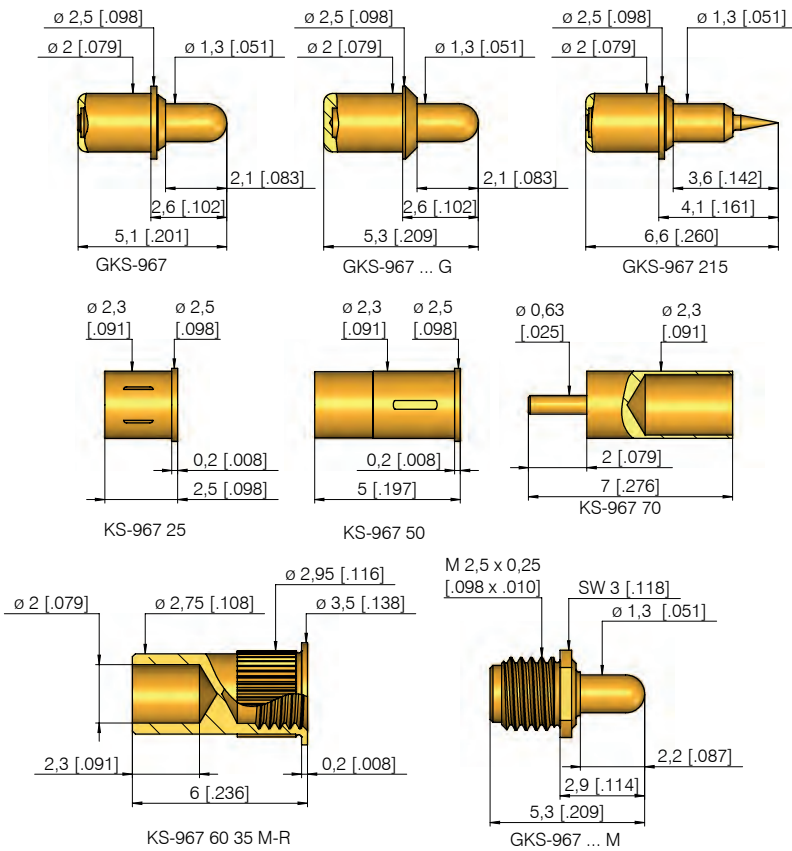

Available tip styles

Material	Tip style	Plating	Further versions	
			\varnothing	\varnothing (inch)
3 02		A		
3 03		A		
3 04		A		
3 05		A		
3 06		A		
2 15*		A		

* Installation height: 4,1 mm (.161)

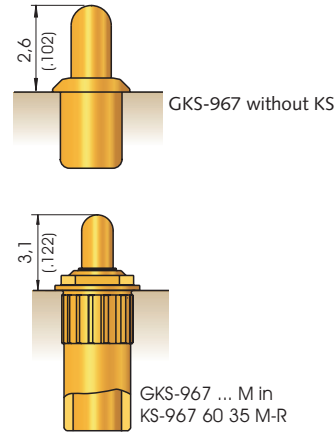

Mechanical data

Working stroke: 1,0 mm (.039)
Maximum stroke: 1,2 mm (.047)
Spring force at work. stroke: 2,0 N (7.2oz)
Alternative: 1,0 N (3.6oz)

Electrical Data

Current rating: 5 - 8 A
R_i typical: < 10 mΩ
 (* < 100 mΩ)

Operating temperature

Standard: -40° up to +80° C
***with special designation "C" or "G":**
 -100° up to +200° C (1,0 N; 2,0 N)

Mounting hole size GKS 967

in CEM1 and FR4 with receptacle: $\varnothing 2,28 - 2,29$ mm (.0898 - .0902)
without receptacle: $\varnothing 2,00$ mm (.0787)

Mounting hole size GKS 967 ... M

in CEM1 und FR4 with receptacle: $\varnothing 2,92 - 2,94$ mm (.1150 - .1157)

Materials

Plunger: BeCu or steel, gold-plated
Barrel: Brass, gold-plated
Spring: Stainless steel*, steel, gold-plated
Receptacle: Brass, gold-plated

Recommended screw-in torque:
 Min.: 3 cNm / Max.: 5 cNm

Ordering example

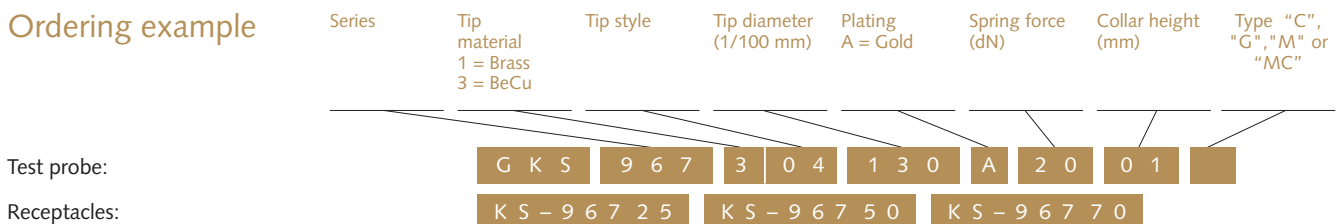

GKS 970

Short-stroke and Charging Test Probes

Grid:

≥ 3 mm

≥ 120 Mil

Installation height with KS: 2,8 mm (.110) respect. 5,3 mm (.209)

Recommended stroke: 1,0 mm (.039) respect. 2,8 mm (.110)

Mounting and functional dimensions

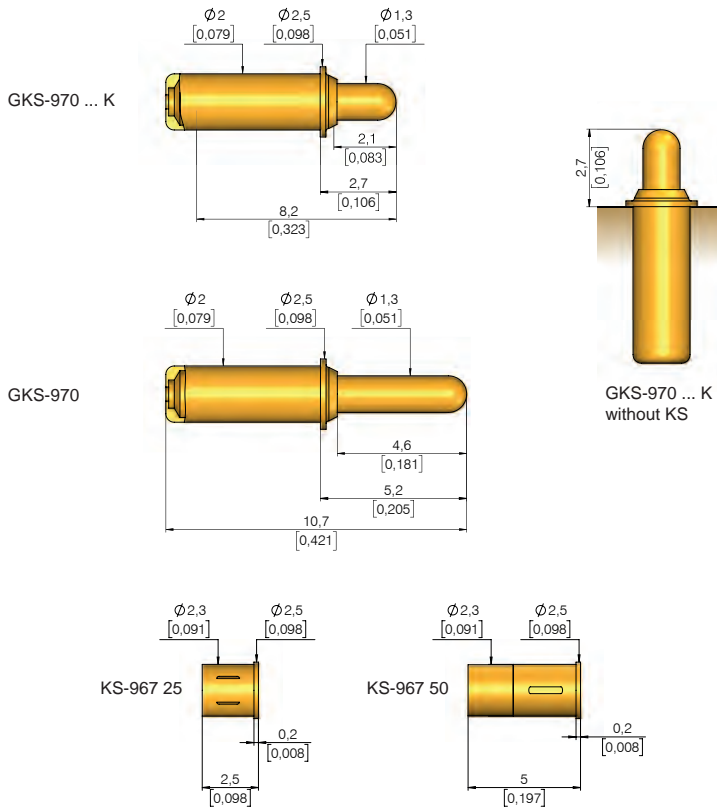

Available tip styles

Material	Tip style	Plating	Further versions	
			∅	∅ (inch)
W	05	A	∅ 1,30 (.051)	

Mechanical data (970 ... K)

Work. stroke: 2,8 mm (.110) (1,0 mm(.039))

Max. stroke: 3,3 mm (.130) (1,7 mm (.067))

Spring force at work.stroke: 1,0 N (3.6oz);
2,0 N (7.2oz); (2,0 N (7.2oz))

Alternative: *1,0 N; *2,0 N (not 970...K)

Materials

Plunger: BeCu, gold-plated

Barrel: Brass, gold-plated

Spring: Stainless steel, steel, gold-plated

Receptacle: Brass, gold-plated

Electrical data (970 ... K)

Current rating: 5 - 8 A

R_i typical: < 20 mΩ

* < 100 mΩ

Mounting hole size

in CEM1 and FR4

with receptacle: ∅ 2,28 - 2,29 mm

(.0898 - .0902)

without receptacle: ∅ 2,0 mm (.0787)

Operating temperature

Standard: -40° up to +80° C

***with special designation "C":**

-100° up to +200° C (1,0 N; 2,0 N)

Ordering example

	Series	Tip material 2 = Steel 3 = CuBe	Tip style	Tip diameter (1/100 mm)	Plating A = Gold	Spring force (dN)	Collar height (mm)	Type alternative: "K"
Test probe:	GKS	970	3	05	130	A	20	01
Receptacles:	KS-967	25	KS-967	50				

Grid:
 ≥ 6,50 mm
 ≥ 260 Mil

Installation height with KS: 7,0 mm (.276)
Recommended stroke: 4,0 mm (.157)

Mounting and functional dimensions

Available tip styles

Material	Tip style	Plating	Further versions	
			∅	∅ (inch)
2 01*		N		
2 04		N		
2 05		N		
2 06		N		

* Angle of tip 60°

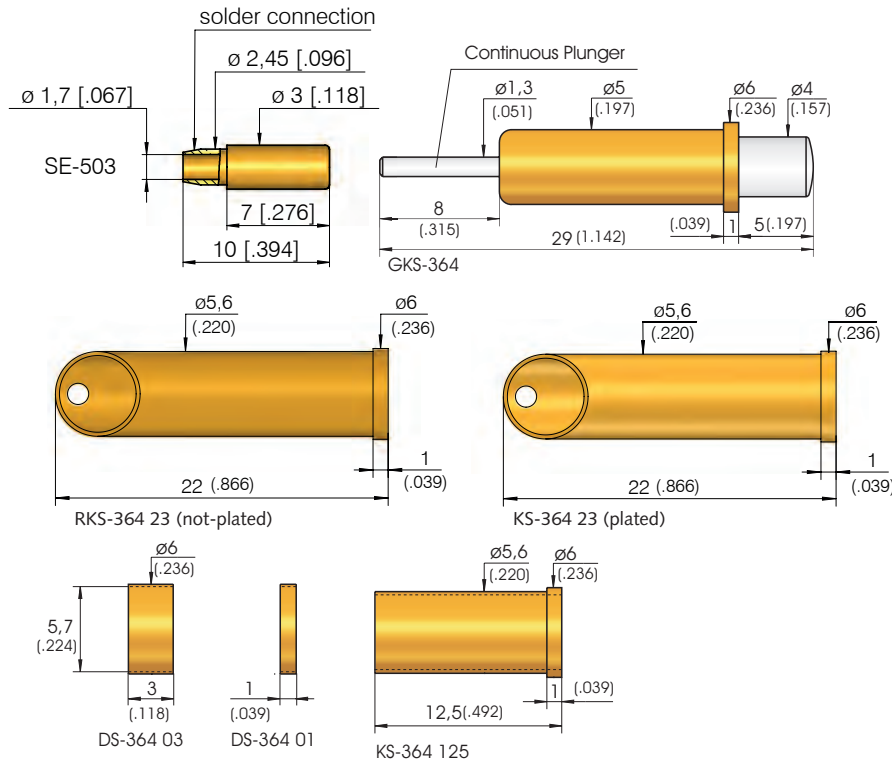

Mechanical data

Working stroke: 4,0 mm (.157)
Maximum stroke: 5,0 mm (.197)
Spring force at work. stroke: 1,5 N (5.4oz)
Alternative: 0,6 N (2.2oz); 3,0 N (10.8oz),
 8,0 N (28.9oz)

Electrical data

Current rating, conn. to plunger: 15-20 A
Current rating, connection to KS: 5 - 8 A
R_i typical, connection to plunger: < 10 mΩ
R_i typical, connection to KS: < 30 mΩ
 (** < 100 mΩ)

Operating temperature

Standard: -40° up to +80° C
****with 1,5 and 3,0 N-spring:**
 -100° up to +200° C

Materials

Plunger: Steel, nickel-plated
Barrel: Brass, gold-plated
Spring: Steel, gold-plated
 or stainless steel**

Receptacles:

RKS-364 23: Brass, not plated
 KS-364 125: Brass, gold-plated

Mounting hole size

with receptacle: $\varnothing 5,59 - 5,60$ mm
 (.2201 - .2205)
without receptacle: $\varnothing 5,00$ mm (.1969)

Ordering example

	Series	Tip material 2 = Steel	Tip style	Tip diameter (1/100 mm)	Plating N = Nickel	Spring force (dN)	Collar height (mm)
Test probe:	G K S	3	6 4	2 0 4	4 0 0	N	1 5 0 1
Receptacles:	R K S - 3 6 4 2 3		K S - 3 6 4 2 3			K S - 3 6 4 1 2 5	
Spacer for receptacle:	D S - 3 6 4 0 3						
Lamellar plug: (for plugging onto the end of the plunger)	S E - 5 0 3						

GKS 365 / GKS 366

Test Probe with High Stability

Grid:

≥ 6,50 mm

≥ 260 Mil

Installation height with KS: 7,0 mm (.276) resp. 12,0 mm (.472)

Recommended stroke: 3,2 mm (.126) reps. 8,0 mm (.315)

Mounting and functional dimensions

GKS 365

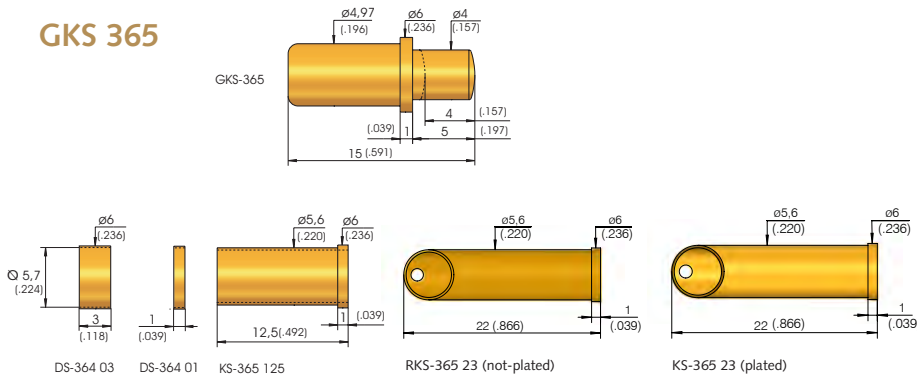

Available tip styles GKS 365

Material	Tip style	Plating	Further versions	
			Ø	Ø (inch)
2 04		N	Ø 4,00 (.157)	
1 05		A	Ø 4,00 (.157)	
2 06		A	Ø 4,00 (.157)	
1 13 *		N	Ø 4,00 (.157)	
1 13S **		A	Ø 4,00 (.157)	

* Nn radial forces allowed, plunger can get stuck

** ordering example: GKS-365 113 400 A xx01 S

GKS 366

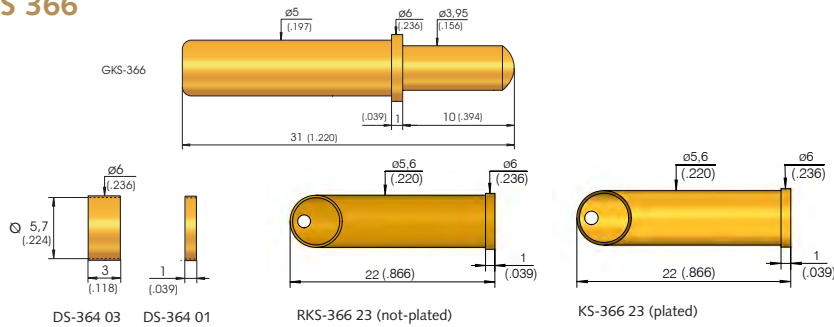

Available tip styles GKS 366

Material	Tip style	Plating	Further versions	
			Ø	Ø (inch)
1 05		N	Ø 4,00 (.157)	
3 05		A	Ø 4,00 (.157)	
3 56 *		A	Ø 4,00 (.157)	

* total length = 30 mm, maximum stroke 9,0 mm

Mechanical data

GKS 365

Working stroke: 3,2 mm (.126)
Maximum stroke: 4,0 mm (.157)
Spring force at work. stroke: 1,5 N (5.4oz)
Alternative: 0,6 N (2.2oz); 3,0 N (10.8oz), 4,0 N (14.4oz); 8,0 N (28.9oz)

Materials

Plunger: Brass or steel, gold- or nickel-plated
Barrel: Brass, gold-plated
Spring: Steel, gold-plated or stainless steel**

Receptacle for GKS-365:

RKS-365 23: Brass, not plated
 KS-365 125: Brass, gold-plated

Receptacle for GKS-366:

RKS-366 23: Brass, not plated
 KS-366 23: Brass, gold-plated

Mechanical data

GKS 366

Working stroke: 8,0 mm (.315)
Maximum stroke: 10,0 mm (.394)
Spring force at work. stroke: 1,5 N (5.4oz)
Alternative: 3,0 N (10.8oz); 6,0 N (21.6oz); 8,0 N (28.9oz); 16,0 N (57.5oz)

Electrical data

Current rating: 5 - 8 A
R_i typical: < 30 mΩ (** < 100 mΩ)

Operating temperature

Standard: -40° up to +80° C
****with 8,0 N-spring:** -100° up to +200° C (GKS-365)

Note:

Other comparable versions available upon request.

Mounting hole size

with receptacle: Ø 5,59 - 5,60 mm (.2201 - .2205)

without receptacle for GKS-365:

Ø 4,97 mm (.1957)

without receptacle for GKS-366:

Ø 5,00 mm (.1969)

Ordering example

Series	Tip material	Tip style	Tip diameter (1/100 mm)	Plating	Spring force (dN)	Collar height (mm)	Special designation "S"
	1 = Brass 2 = Steel			A = Gold N = Nickel			

Test probe:

G K S 3 6 5 1 0 5 4 0 0 A 1 5 0 1

Test probe:

G K S 3 6 6 1 0 5 4 0 0 N 1 5 0 1

Receptacles for GKS-365:

R K S - 3 6 5 2 3 K S - 3 6 5 2 3 A

Receptacles for GKS-366:

R K S - 3 6 6 2 3 K S - 3 6 6 1 2 5 K S - 3 6 6 2 3

Spacer for receptacle:

D S - 3 6 4 0 1 D S - 3 6 4 0 3

Grid:
 ≥ 1,91 mm
 ≥ 75 Mil

Installation height without KS: 17,5 mm (.689)
Recommended stroke: 3,2 mm (.126)

GKS 941

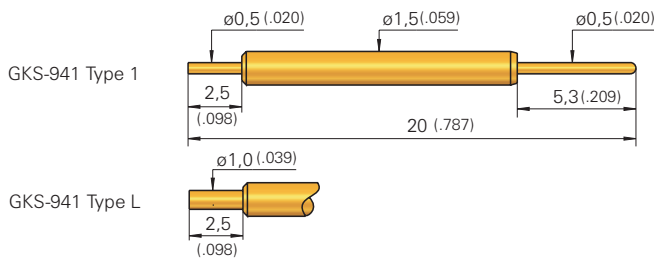

		Available tip styles		
Material	Tip style	Plating	Further versions	
			∅	∅ (inch)
3	01	R	∅ 0,50 (.020)	
3	05	A	∅ 0,50 (.020)	

GKS 064

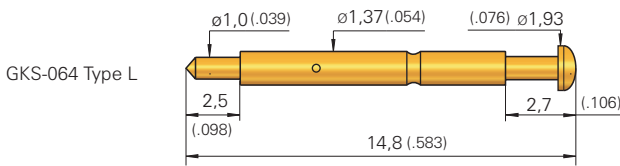

Grid:
 ≥ 2,54 mm
 ≥ 100 Mil
Installation height without KS: 12,3 mm (.484)
Recommended stroke: 1,4 mm (.055)

		Available tip styles		
Material	Tip style	Plating	Further versions	
			∅	∅ (inch)
3	05	A	∅ 1,93 (.076)	

GKS 986

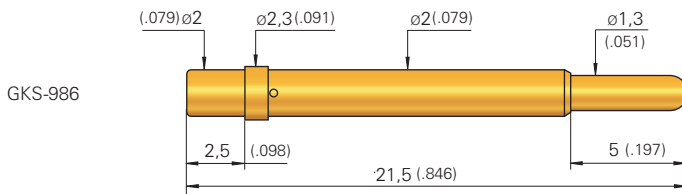

Grid:
 ≥ 2,54 mm
 ≥ 100 Mil
Installation height without KS: 19,0 mm (.748)
Recommended stroke: 3,0 mm (.118)

		Available tip styles		
Material	Tip style	Plating	Further versions	
			∅	∅ (inch)
1	05	A	∅ 1,30 (.051)	

Mechanical data	GKS 941	GKS 064	GKS 986
Working stroke:	3,2 mm (.126)	1,4 mm (.055)	3,0 mm (.118)
Maximum stroke:	4,0 mm (.157)	1,7 mm (.067)	5,0 mm (.197)
Spring force at work. stroke:	0,8 N (2.9oz)*	0,4 N (1.4oz)	1,0 N (3.6oz)*
Alternative:	1,7 N (6.1oz); 3,5 N (12.6oz)	0,2 N (0.7oz); 0,6 N (2.2oz)	

Other solderable test probes:
 see GKS-913, others also available.

Warning:
 Probes should be soldered with great care. Ensure the inside of the barrel is not exposed to high temperatures, because this could destroy the spring.

Electrical data	GKS 941	GKS 064	GKS 986
Current rating:	5 - 8 A	5 - 8 A	5 - 8 A
R_i typical:	<100 mΩ	<100 mΩ	<100 mΩ

Operating temperature
Standard: -40° up to +80° C
***with 0,8 N + 1,0 N-spring:** -100° up to +200° C

Materials	GKS 941	GKS 064	GKS 986
Plunger:	BeCu, gold- or rhodium-plated	see GKS 941	Brass, gold-plated
Barrel:	Brass, gold-plated	see GKS 941	Brass, gold-plated
Spring:	Steel, gold-plated *0,8 N, stainless steel, gold-plated	see GKS 941	Steel, gold-plated *0,8 N, stainless steel, gold-plated

Ordering example

	Series	Tip material 1 = Brass 3 = BeCu	Tip style	Tip diameter (1/100 mm)	Plating A = Gold R = Rhodium	Spring force (dN)	Collar height (mm)	Type "1" resp. "L"	
Test probe with terminal post ∅ 0,5 or 1,0 mm:	G K S	9 4 1	3	0 1	0 5 0	R	0 8	0 0	1 or L
Test probe with terminal post ∅ 1,0 mm:	G K S	0 6 4	3	0 5	1 9 3	A	0 4	0 0	L
Test probe:	G K S	9 8 6	1	0 5	1 3 0	A	1 0	0 1	

Accessories

Test Probe/Test Fixture

In addition to the classic range of test probes for the testing of PC boards and components, further test probes are available as test accessories:

Interface GKS and contact terminals are used in interface blocks to reliably transfer signals in internal, external, and customised interfaces.

Stroke measurement probes are used to determine the working stroke of a test probe when contacting a DUT. This can be helpful when selecting the optimal test probe, or solving contact issues which may arise.

PCB support pins provide a spring-loaded base when inserting the PCB in the test fixture or inline test device, especially in test set-ups without a PCB support plate.

Assorted accessories applications

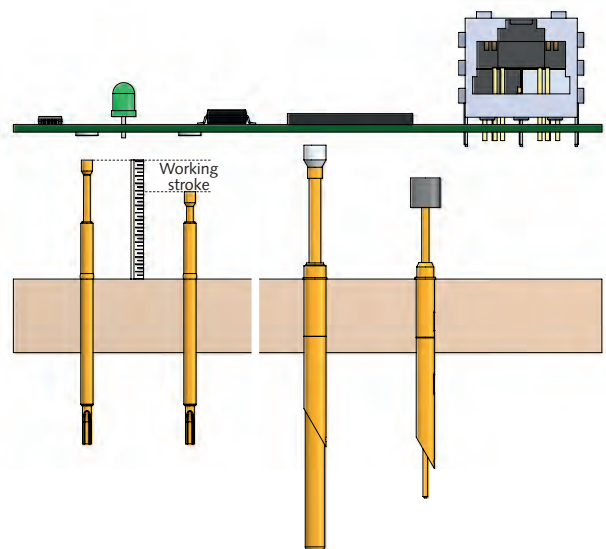
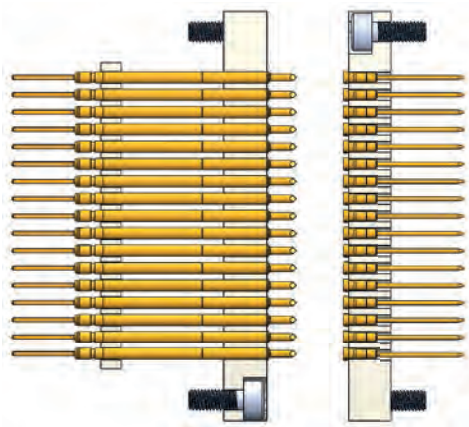

	Design of signal transfer positions	Testing of test probe or DUT working stroke	Probes to support PCB in test fixture
Grid size / series	Interface test probes and contact terminals	Stroke-measuring probes	PCB support probes
≥ 1.91 mm (≥ 75 Mil)	-	HMS-075	-
≥ 2.54 mm (≥ 100 Mil)	GKS-945/946/938/100	HMS-100/135/422	-
4.0 bis 5.5 mm (160 bis 220 Mil)	-	-	GKS-416/504 GKS-102/414
Page(s)	190 - 191	192	193

Interface test probes and contact terminals are used in interface blocks to reliably transfer signals in internal, external, and customised interfaces.

In order to realise the optimal transfer, several varied GKS and contact terminals with a variety of tip styles, installation heights, and connection options are available.

Stroke measurement probes are used to define the working stroke of a test probe when contacting a DUT. This can be helpful when selecting the optimal test probe, or solving contact issues which may arise.

In order to determine the stroke, the stroke measurement probes (HMS) are inserted in a receptacle mounted in the test fixture. When the fixture is closed (with the DUT in place) the HMS is activated and remains in the new position. Then the performed stroke can be determined (by measuring the difference between the starting position and the end position). The HMS plunger can be returned to the home position manually after the measurement is complete.

PCB support pins provide a spring-loaded base when inserting the PCB in the test fixture or inline test device, especially in test set-ups without a PCB support plate.

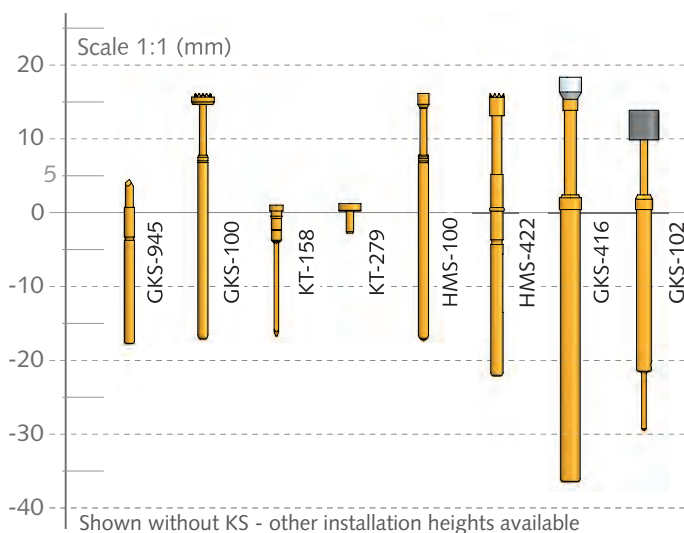

Accessories

Interface Test Probes and Contact Terminals

GKS-945	190
GKS-946	190
GKS-938	190
GKS-100 357 150 ...	190
GKS-100 307 150 ...	190
GKS-100 306 229 ...	190
Contact Terminals	191

Stroke Measurement Probes

HMS-075	192
HMS-100	192
HMS-422	192

PCB Support Pins

GKS-416	193
GKS-504	193
GKS-102	193
GKS-414	193

Note:

See next page for overview and comparison table.

Accessories

Overview and Comparison

Test probe version	Series	Grid size (≥ mm)	Working stroke (mm)	Max. stroke (mm)	Current rating (A)	Spring forces (N)		Installation height with receptacle (mm)		Shortest probe (mm)	Page
						min.	max.	min.	max.		
Interface test probes and contact terminals	GKS-945	2.54	2.1	3.2	5	1.1	1.3	3.7	4.3	21.7	190
	GKS-946	2.54	3.2	3.9	5	1.2	-	4.4	-	22.4	190
	GKS-938	2.54	3.6	4.3	5	1.5	-	6.8	-	24.8	190
	GKS-100 357 150 ...	2.54	3	4	5	1.2	-	13.6	-	31	190
	GKS-100 307 150 ...	2.54	4.3	6.35	5	1	3	16	-	33.4	190
	GKS-100 306 229 ...	5.08	4.3	6.35	5	1	3	16	-	33.4	190
	Contact terminals	-	-	-	-	-	-	-	-	-	-
Stroke measurement probes	HMS-075	1.91	4.3	6.35	-	-	-	7.7	-	25.4	192
	HMS-100	2.54	4.3	6.35	-	-	-	8.4	-	25	192
	HMS-422	2.54	6.4	8	-	-	-	16	-	38.4	192
PCB support pins	GKS-416	4	9.2	11.5	-	5	-	18.2	20	55	193
	GKS-504	4	11.2	14	5 – 8	0.5	5	18.2	24	56	193
	GKS-102	4.5	4.8	6.5	-	1.5	5	13.75	-	43.5	193
	GKS-414	5.5	9.6	11.2	5 – 8	1.5	3	16	-	40.8	193

Sealed with **EXCELLENCE.**

Individual functionality for particularly challenging test requirements. All **accessories** are suitable for use with all versions in INGUN's test fixture series:

- Lifting units
- Marking units
- Interface blocks
- Side approach mechanism
- Push rods

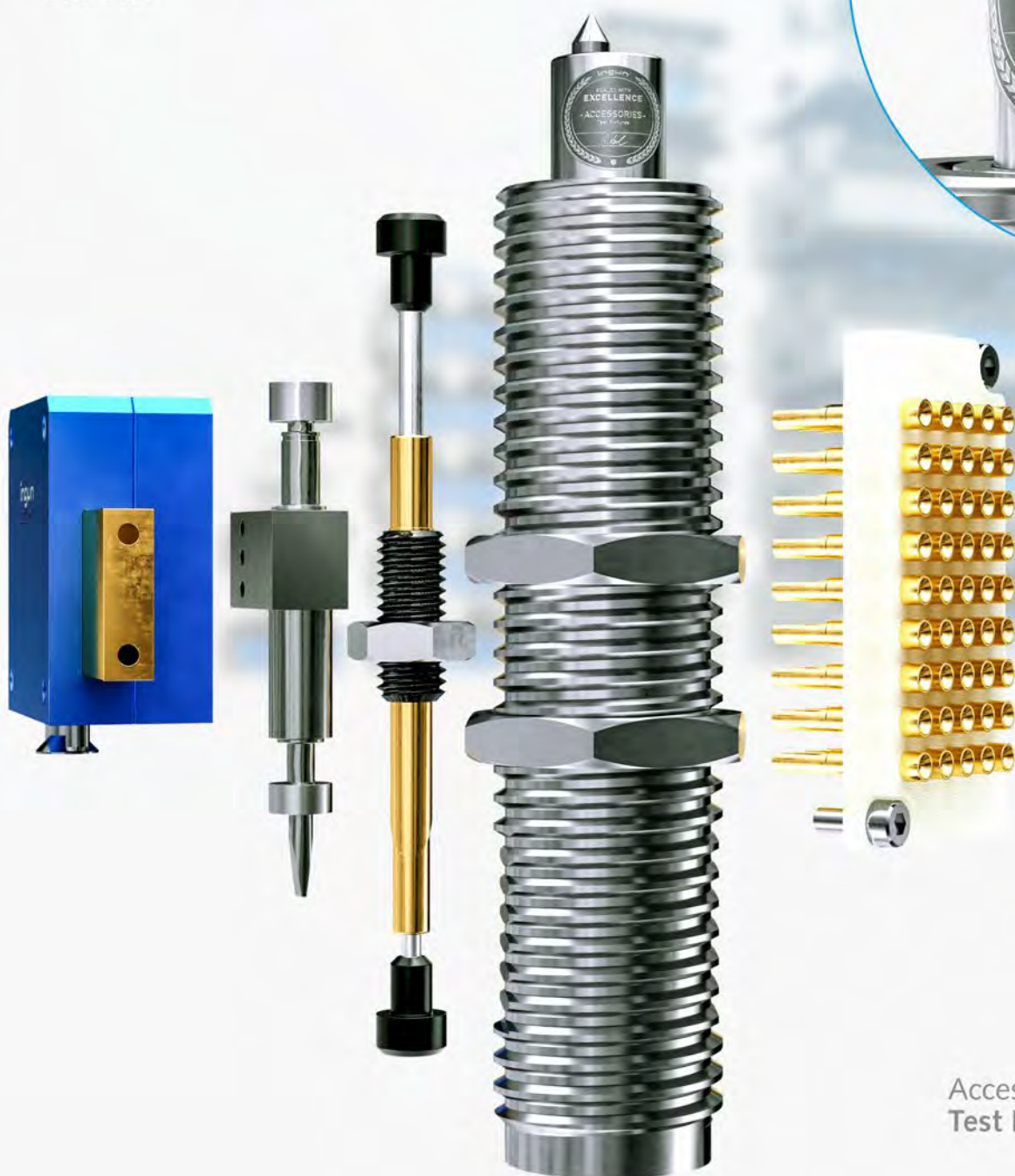

Accessories
Test Fixtures

www.ingun.com

Test Probes for Interfaces

from INGUN, GenRad, Pylon, R & S, Teststation, Teradyne and Keysight (Agilent/HP 3070)

Mounting and functional dimensions

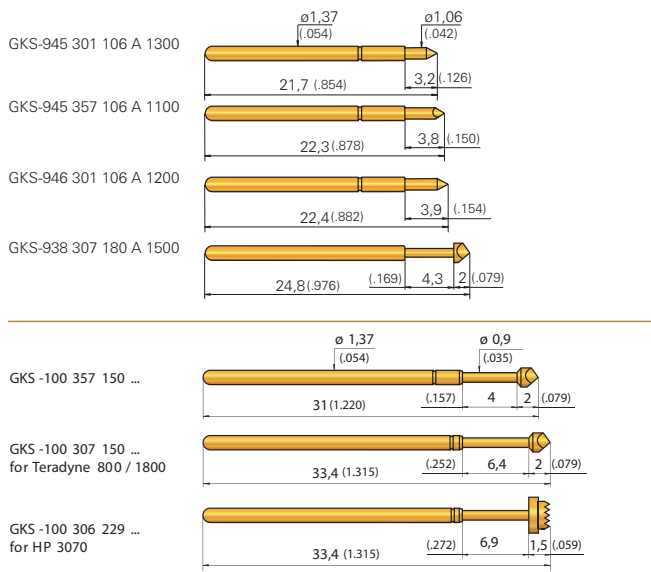

Receptacles

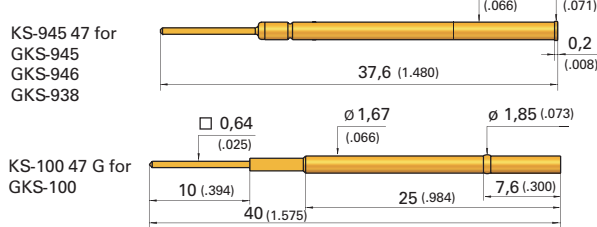

Mechanical data

Type	Working stroke mm (inches)	Max. stroke mm (inches)	Spring force at working stroke N (oz)	Installation height with KS mm (inches)
945 301	2,1 (.083)	3,2 (.126)	1,3 N (4.7oz)	3,7 (.146) *
945 357	2,6 (.102)	3,2 (.126)	1,1 N (4.0oz)	4,3 (.169) *
946 301	3,2 (.126)	3,9 (.154)	1,2 N (4.3oz)	4,4 (.173) *
938 307	3,6 (.142)	4,3 (.169)	1,5 N (5.4oz)	6,8 (.268) *
100 357	3,0 (.118)	4,0 (.157)	1,2 (Ord.-No.=10)	13,6 (.535) / variable **
100 ...	4,3 (.169)	6,35 (.250)	1,0/2,0/2,25/3,0	16,0 (.630) / variable **

*with KS-945 47 ** with KS-100 47 G

Mounting hole size ***

for KS-945 47:
- in CEM1 using collar $\phi 1,68 - 1,69$ mm (.0661 - .0665)

for KS-100 47 G:
- press ring inserted
in CEM1: $\phi 1,71 - 1,73$ mm (.0673 - .0681)
in FR4: $\phi 1,70 - 1,72$ mm (.0669 - .0677)

Electrical data

Current rating: 4 - 5 A
R_i typical: 20 m Ω

Materials

Plunger: BeCu , gold-plated
Barrel: Nickel-silver or Bronze, gold-plated
Spring: Steel, gold-plated

Collar height and installation height

The installation height is variable, depending on position of the press ring.

Operating temperature

Standard: -40° up to +80 °C

Ordering example

	Series	Tip material 3 =BeCu	Tip style	Tip diameter (1/100 mm)	Plating A = Gold	Spring force (dN)	Collar height (mm)	Special designation ("B", see Note)
Test probe:	G K S	3	9 4 5	3 0 1	A	1 3	0 0	
Receptacle for GKS 945 / 946 / 938:	K S		9 4 5	4 7				
Receptacle for GKS-100:	K S		1 0 0	4 7 G				

GKS-945 / 946 for GenRad/Pylon Augat/R&S-Interfaces				
Material	Tip style	Plating	Further versions	
			ϕ	ϕ (inch)
3	01	A	$\phi 1,06$ (.042)	
3	57 *	A	$\phi 1,06$ (.042)	

* Available only for GKS-945

GKS-938				
Material	Tip style	Plating	Further versions	
			ϕ	ϕ (inch)
3	07	A	$\phi 1,80$ (.071)	

GKS-100				
Material	Tip style	Plating	Further versions	
			ϕ	ϕ (inch)
3	57	A	$\phi 1,50$ (.059)	

GKS-100 for Teradyne 800/1800 Interface				
Material	Tip style	Plating	Further versions	
			ϕ	ϕ (inch)
3	07	A	$\phi 1,50$ (.059)	

GKS-100 for Agilent/HP 3070 Interface				
Material	Tip style	Plating	Further versions	
			ϕ	ϕ (inch)
3	06	A	$\phi 2,29$ (.090)	

*** Services:

Customised contact blocks drilled according to customer demands (and which match certain INGUN receptacles) are available from INGUN.

Note:

To order test probes with bent barrel end, use special designation "B" (banana-shaped).
Contacting terminals for various interfaces available upon request.

Grid:
 $\geq 2,54 \text{ mm}$
 $\geq 100 \text{ Mil}$

Contact terminals with collar height: 3 mm (.118)

KT-254 W-E03 (wire-wrap)

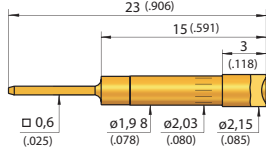

KT-254 W3 E03 (wire-wrap)

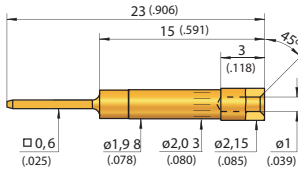

KT-254 L-E03 (Solder)

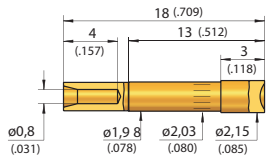

KT-254 L3 E03 (Solder)

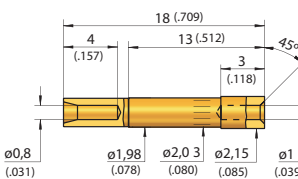

KT-120 L3 E02 - 30 (Solder)
High-current Contact Terminal

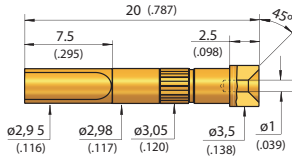

KT-150 L3 E03 - M3
High-current Contact Terminal

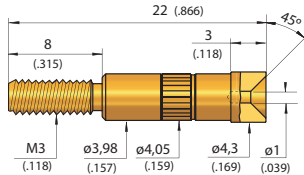

Contact terminals with collar height: 2 mm (.079)

KT-254 W-E02 (wire-wrap)

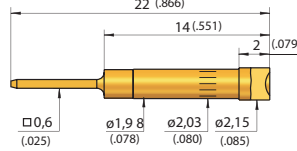

KT-254 W3 E02 (wire-wrap)

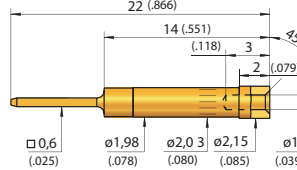

KT-254 L-E02 (Solder)

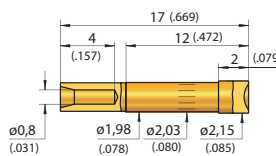

KT-254 L3 E02 (Solder)

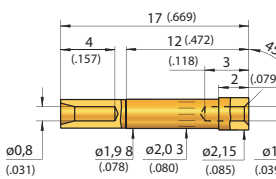

KT-254 L3 E02 - 30 (Solder Connection)

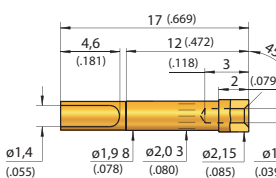

KT-254 W-PL (wire-wrap)

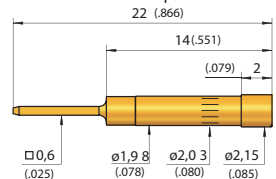

Other contact terminals:

KT-254 W3 E12 (wire-wrap)
For assembly in INGUN ZSK Transfer Field (ZSK = Top-side Contacting Unit)

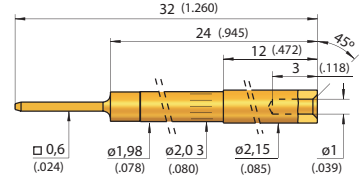

KT-158 02 (Order No. 9408)
Contacting Terminal for GenRad Interface

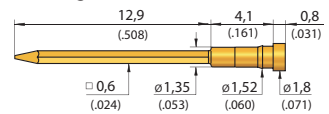

KT-158 (Order No. 3650)
Contacting Terminal for Zehntel Interface

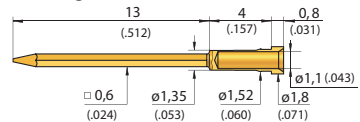

KT-158 06 (Order No. 21814)

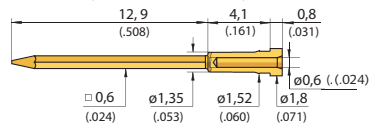

KT-586 102 400 R
Contacting Terminals for general usage

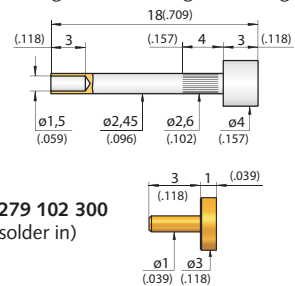

KT-279 102 300
(to solder in)

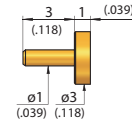

KT-112 143 215 E02 (replaceable, will be used with KS-112)

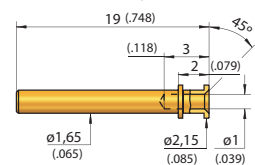

Mounting hole size *

for KT-254:
in CEM1 und FR4 $\varnothing 1,98 - 1,99 \text{ mm}$ (.0780-.0783)

for KT-158:
in CEM1 and FR4 $\varnothing 1,38 - 1,40 \text{ mm}$ (.0543 - .0551)

for KT-586:
in CEM1 and FR4 $\varnothing 2,55 - 2,57 \text{ mm}$ (.1004-.1012)

for KT-120:
in CEM1 and FR4 $\varnothing 3,00 - 3,02 \text{ mm}$ (.1181 - .1189)

for KT-150:
in CEM1 and FR4 $\varnothing 4,00 - 4,02 \text{ mm}$ (.1575 - .1583)

Collar height and install. height for KT-254

The installation height of the contact terminals is determined by the collar height.

Electrical data

R_j typical: $< 5 \text{ m}\Omega$

Materials

Contact terminals: Brass, gold-plated
KT-586: Brass, rhodium-plated

*** Services:**

Customised contact blocks drilled according to customer demands (which match certain INGUN receptacles) are available from INGUN.

Stroke Measurement Probe

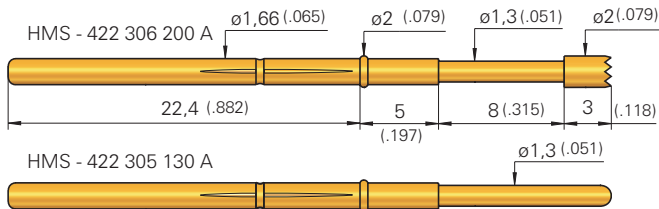
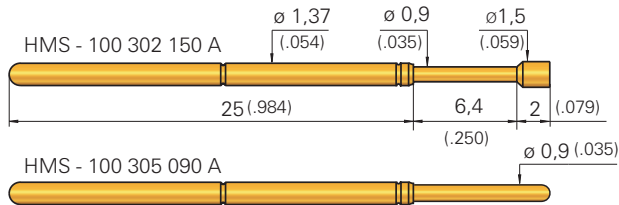
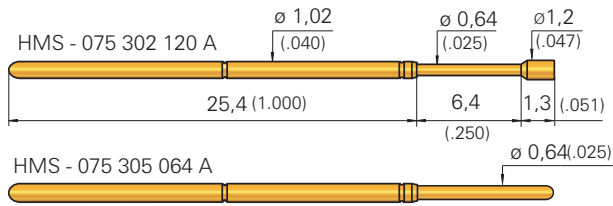

Description measurement probe

Test probe for checking the stroke of a test fixture. Procedure:

1. Install HMS instead of standard probe
2. Activate test fixture which compresses the plunger of the HMS. Crimps on the barrel of the probe hold the plunger down in the activated position.
3. After de-activating the test fixture, the stroke can now be measured on the compressed plunger.

Note: The plunger can easily be retracted and the probe re-used many times.

Application area

Tip style "05":

- For contacting test pads

Tip styles "02" / "06":

- For contacting component pins

Further versions or series available upon request.

Ordering example

Stroke measurement probe:

Series	Tip material 3 = BeCu	Tip style	Tip diameter (1/100 mm)	Plating A = Gold
HMS	075	305	064	A
HMS	100	302	150	A
HMS	422	306	200	A

PCB support probe GKS-416

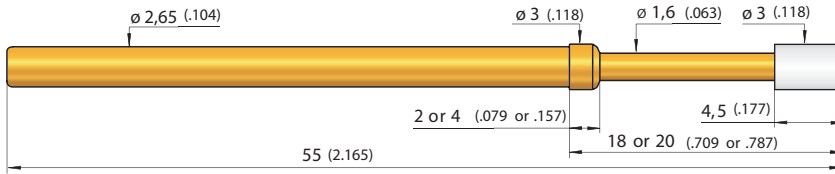

Mechanical data

Working stroke: 9,2 mm (.362)
Maximum stroke: 11,5 mm (.453)
Spring force at work.stroke: 5,0 N (18.1oz)

Materials

Plunger: BeCu , gold-plated
Barrel: Brass, gold-plated
Spring: Steel, gold-plated
Tip: Delrin
Receptacle: KS-113 23

Mounting hole size

see GKS-113 (page 68)

Ordering example

GKS for install. height 18,0 mm (.709):

G	K	S	4	1	6	0	0	2	3	0	0	A	5	0	0	2
---	---	---	---	---	---	---	---	---	---	---	---	---	---	---	---	---

GKS for install. height 20,0 mm (.787):

G	K	S	4	1	6	0	0	2	3	0	0	A	5	0	0	4
---	---	---	---	---	---	---	---	---	---	---	---	---	---	---	---	---

PCB support probe GKS-102

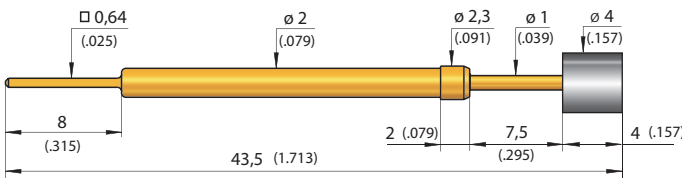

Mechanical data

Working stroke: 4,8 mm (.189)
Maximum stroke: 6,5 mm (.256)
Spring force at work. stroke: 1,5 N (5.4oz)
Alternative: 3,0 N (10.8oz); 5,0 N (18.1oz)

Materials

Plunger: Steel , gold-plated
Barrel: Brass, gold-plated
Spring: Steel, gold-plated
Tip: PVC
Receptacle: KS-102 23

Mounting hole size

see GKS-102 (page 66)

Ordering example

GKS for install. height 13,5 mm (.531):

G	K	S	1	0	2	2	5	0	4	0	0	P	3	0	0	2	W
---	---	---	---	---	---	---	---	---	---	---	---	---	---	---	---	---	---

Test probe GKS-504

With continuous plunger, for the activation of micro switches

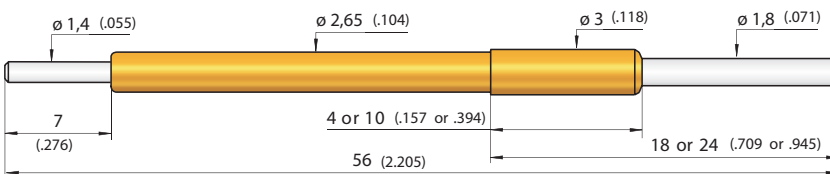

Mechanical data

Working stroke: 11,2 mm (.441)
Maximum stroke: 14 mm (.551)
Spring force at work. stroke: 0,5 N (1.8oz)
Alternative: 3,0 N (10.8oz); 5,0 N (18.1oz)

Materials

Plunger: BeCu , nickel-plated
Barrel: Steel, gold-plated or stainless steel
Spring: Brass, gold-plated
Receptacle: KS-113 23

Mounting hole size

see GKS-113 (page 68)

Ordering example

GKS for install. height 18,0 mm (.709):

G	K	S	5	0	4	3	0	5	1	8	0	N	0	5	0	4
---	---	---	---	---	---	---	---	---	---	---	---	---	---	---	---	---

GKS for install. height 24,0 mm (.945):

G	K	S	5	0	4	3	0	5	1	8	0	N	5	0	1	0
---	---	---	---	---	---	---	---	---	---	---	---	---	---	---	---	---

GND probe GKS-414

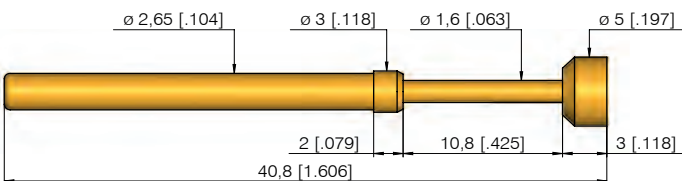

Mechanical data

Working stroke: 9,6 mm (.378)
Maximum stroke: 10,8 mm (.425)
Spring force at work. stroke: 1,5 N (5.4oz)
Alternative: 3,0 N (10.8oz)
Receptacle: KS-113 23 (shown on page 68)

Mounting hole size

see GKS-113 (page 68)

Ordering example

GKS for install. height 15,8 mm (.622):

G	K	S	4	1	4	2	0	2	5	0	0	A	1	5	0	2
---	---	---	---	---	---	---	---	---	---	---	---	---	---	---	---	---

Tools

To press in receptacles and spring-loaded test probes (GKS)

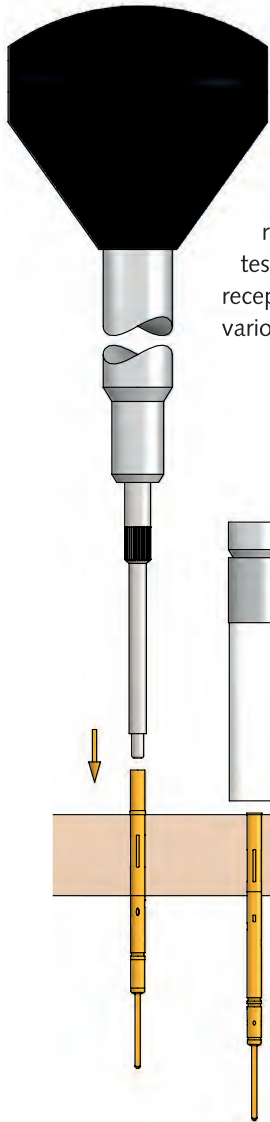

INGUN tools make an important contribution to secure, precise testing. Only with optimally installed receptacles and test probes, can reliable testing be guaranteed. Depending on the receptacle and test probe to be installed, various tools and bits are available.

Receptacles are pressed into the probe plate, either up to the collar stop or by pressing the press ring to allow for variable adjustment of the installation height. Depending on their design, spring-loaded test probes are pressed into or screwed into the receptacle using a suitable tool. There are optimally matched bit inserts, according to tip style and diameter of the probe.

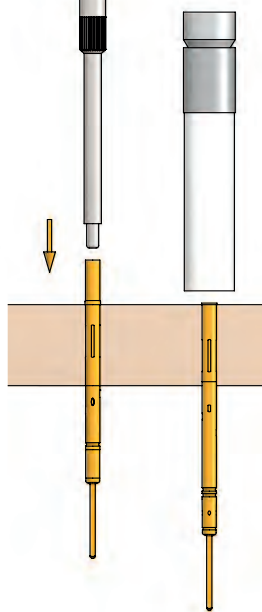

KS with fixed depth (stop)

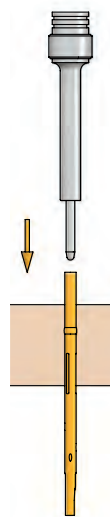

KS with variable depths (press ring)

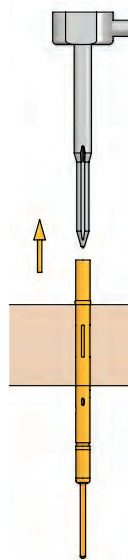

Remove KS

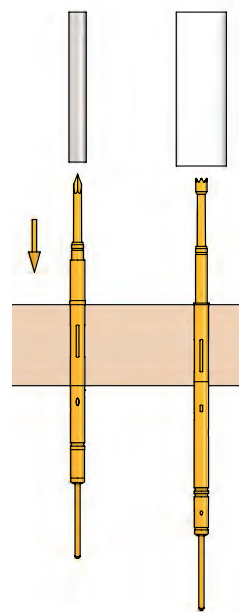

Install GKS in KS

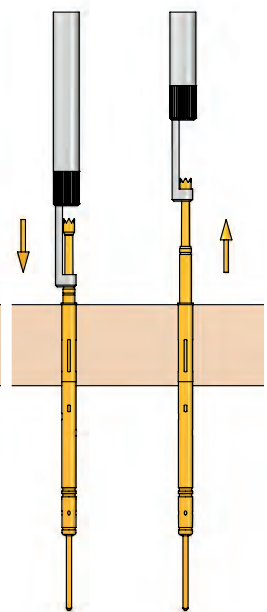

Install and remove GKS in KS (head- \varnothing > plunger shaft- \varnothing)

Receptacle (KS) installation and removal			Test probe (GKS) installation and removal	
SW-KS-xxx (SW-GKS)	SW-KS-xxx-G	NEW AW-KS-SET-ICT AW-KS-SET-CABLE	SW-GKS-xxx (SW-GKS)	SW-ZW-GKS-xxx
Press-in tools for KS with stop. SW-KS-xxx tool with optimal guide and kink protection recommended especially for installation of thin KS. Depending on KS version, the collar or press ring is used as the stop.	Press-in tools for KS at variable depths. The KS press ring is sunk in the mounting hole. This allows the installation height to be adjusted (KS+GKS).	Extraction tool for easy removal of KS. The tool is screwed in the KS. The KS is then pulled out by way of a sprung mass (drop weight) mechanism.	Tools to insert GKS in KS. The SW-GKS-xxx tool recommended to avoid damage while installing GKS with head- $\varnothing \leq$ plunger shaft- \varnothing .	Insertion/extraction tool for GKS. The SW-GKS-xxx tool recommended to avoid damage while installing GKS with head- $\varnothing \leq$ plunger shaft- \varnothing . Only GKS with head - $\varnothing >$ plunger shaft - \varnothing can be removed using this tool.

Screw-in Tools for Test Probes

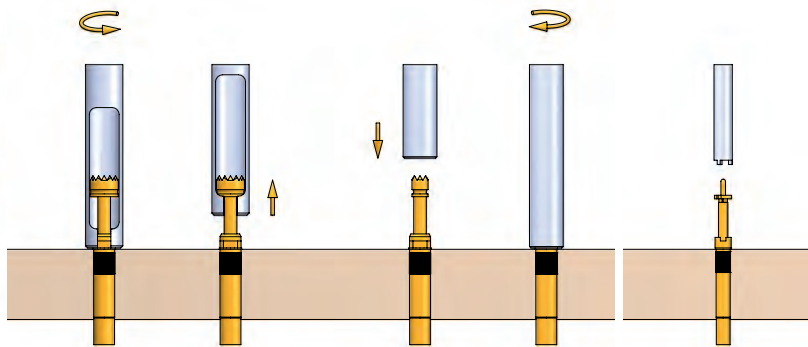

Torque screwdriver

Bit insert for barrel with spanner flat

Bit insert for interlocking connection

Test probe (GKS) screw in and unscrew

DW-x-S (DW-x)	BIT-GKS M BIT-GKS-xxx M-B	BIT-T-xxx M
<p>Torque screwdriver to screw GKS into KS.</p> <p>Pre-adjusted torque screw drivers are available in 1, 3.5 and 20 cNm versions.</p> <p>Adjustable Torque screw drivers available in 5-40 and 20-120 cNm.</p>	<p>Bit insert to screw GKS into KS.</p> <p>BIT-GKS-xxx M are the standard tools for GKS, especially when the head-Ø ≥ spanner flat width on probe.</p> <p>BITGKS- xxx M-B are for GKS with head-Ø ≤ spanner flat width on probe. Especially for installing GKS with limited pitch distance (small grid).</p>	<p>Bit insert to screw step probe into KS. The screw-in torque is transmitted using an interlocking connection.</p>

Tools

KS installation and removal

SW-KS-xxx	196
SW-GKS	196
SW-KS-xxx-G	196 NEW
AW-KS-Set-ICT / CABLE	196

GKS installation and removal

SW-GKS-xxx	196
SW-GKS	196
SW-ZW-GKS-xxx	196

GKS screw-in and unscrew

DW-x-S	197 - 198
DW-x	197 - 198
BIT-GKS-xxx M	197 - 198
BIT-GKS-xxx M-B	197 - 198
BIT-T-xxx M	197 - 198

Note::
See next page for overview and comparison table.

Insertion and Extraction Tools

Series	Insertion Tool für GKS	Insertion and Extraction Tool for GKS, Tip-Ø > Shaft-Ø	Insertion Tool for KS
GKS-001	SW-GKS		
GKS-002	SW-GKS	SW-ZW-GKS-100	SW-KS 100 / SW-KS-100 G [4]
GKS-003	SW-GKS		SW-KS-102
GKS-004	SW-GKS		
GKS-005	SW-GKS		
GKS-015	SW-GKS-081 [1]		SW-KS-050 G [4]
GKS-035		SW-ZW-GKS-075	SW-KS-101 / SW-KS-075 G [4]
NEW GKS-040			SW-KS-040 / SW-KS-040 G [4]
XXX-050	SW-GKS-081 [1]		SW-KS-050 G [4]
GKS-069	SW-GKS-187 B		SW-KS-080
XXX-075		SW-ZW-GKS-075	SW-KS-101 / SW-KS-075 G [4]
GKS-080		SW-ZW-GKS-080	SW-KS-080
GKS-081	SW-GKS-081 [1]		SW-KS-080
GKS-098	SW-GKS		SW-KS-103
XXX-100	SW-GKS-100 B [1]	SW-ZW-GKS-100	SW-KS 100 / SW-KS-100 G [4]
GKS-101		SW-ZW-GKS-101	SW-KS-101
GKS-102		SW-ZW-GKS-112	SW-KS-102
GKS-103		SW-ZW-GKS-103	SW-KS-103
GKS-112		SW-ZW-GKS-112	SW-KS-112
GKS-113		SW-ZW-GKS-103	SW-KS-113
GKS-135	SW-GKS-100 B [1]	SW-ZW-GKS-100	SW-KS 100 / SW-KS-100 G [4]
GKS-181	SW-GKS-181 [1]	ZW-GKS-912	SW-KS-181
GKS-204	SW-GKS-912 A [2] / 912 B [3]	ZW-GKS-912	SW-KS-112
GKS-412		SW-ZW-GKS-112	SW-KS-112
XXX-422	SW-GKS-912 A [2] / 912 B [3]	ZW-GKS-912	SW-KS-112
GKS-502		SW-ZW-GKS-112	SW-KS-102
GKS-503		SW-ZW-GKS-103	SW-KS-103
GKS-550	SW-GKS-181 [1]		SW-KS-050 G [4]
GKS-710		ZW-GKS-912	SW-KS-112
GKS-713	SW-GKS		SW-KS-113
GKS-714	SW-GKS		SW-KS-113
GKS-725		SW-ZW-GKS-100	SW-KS-100
GKS-912	SW-GKS-912 A [2] / 912 B [3]	ZW-GKS-912	SW-KS-112
GKS-913		SW-ZW-GKS-103	SW-KS-113
NEW GKS-961	SW-GKS-961		
GKS-967	SW-GKS		SW-KS-102
HSS-118		SW-ZW-GKS-112	SW-KS-112
HSS-120		SW-ZW-GKS-103	SW-KS-113
HSS-150	SW-GKS		
PKS-200/220	SW-GKS		SW-KS-102
PKS-300/299	SW-GKS		SW-KS-103
NEW SKS-075		SW-ZW-GKS-075	SW-KS-075 G [4]
SKS-100		SW-ZW-GKS-100	SW-KS-100 G [4]
SKS-215		SW-ZW-GKS-112	SW-KS-112
SKS-415/425		SW-ZW-GKS-103	SW-KS-113
SKS-419/429	SW-SKS-419-429-300		
SKS-419/429	SW-SKS-419-429-500		

^[1] Insertion tool for plunger with continuous shaft

^[2] universal use

^[3] for tip style "09"

^[4] free adjustable

^[5] extraction tool

Ordering example

Insertion and extraction tools for GKS 112:

SW-ZW-GKS-112

Insertion tools for GKS 912:

SW-GKS-912 A or SW-GKS-912 B

Bits for insertion tools GKS 912:

E-SW-GKS-912 A or E-SW-GKS-912 B

Extraction tool for receptacles:

AW-KS-Set-ICT AW-KS-Set-CABLE

SW-GKS: Universal insertion tool for GKS

SW-KS-xxx G (4): Variably adjustable insertion tool, for receptacle with press ring (* can be purchased individually)

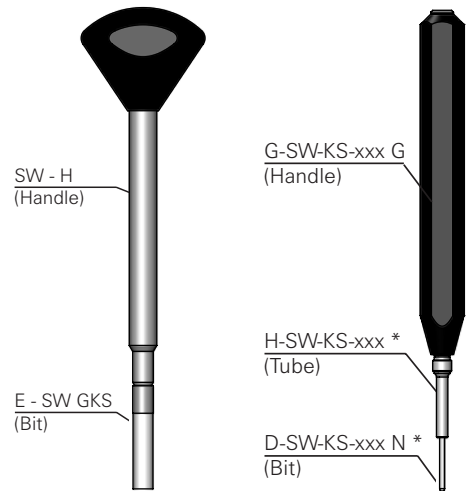

AW-KS-Set-ICT / AW-KS-Set-CABLE: **NEW** Extraction tool for KS

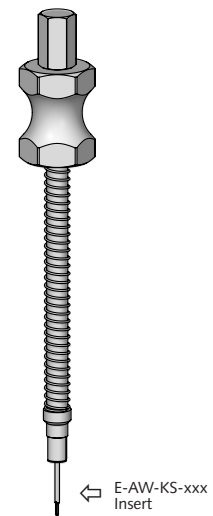

The set for extraction of receptacles contains the bits E-AW-KS-xxx for the series, e.g. E-AW-KS-040 for KS-040. **NEW**

	AW-KS-Set-ICT	AW-KS-Set-CABLE
E-AW-KS-xxx Bits	E-AW-KS-040	E-AW-KS-075
	E-AW-KS-050	E-AW-KS-100
	E-AW-KS-075	E-AW-KS-112
	E-AW-KS-100	E-AW-KS-113

Torque Screwdriver with BIT tools

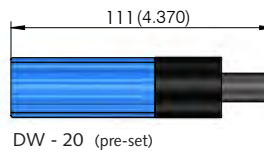
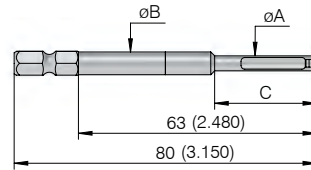
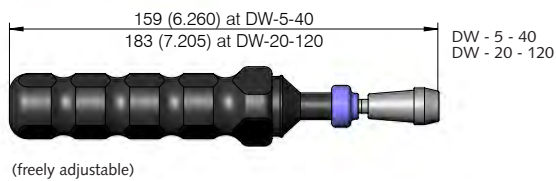
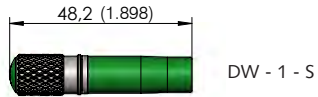

Series	Plunger tip-Ø (Disk-Ø)	Bit-tool	Ø A	Ø B	C	Torque key			Recommend screw-in torque		Insertion tools for receptacles
						(mm)			pre-set	freely adjustable	
NEW DPS-215 M	≤ 2.0 mm	BIT-GKS-112 M-B	2.7	5	30	DW-5-S	DW-5-40	-	3 cNm	5 cNm	SW-KS-112
NEW DPS-465 M	≤ 2.5 mm	BIT-SKS-465 M-B	4	4	-	DW-5-S	DW-5-40	-	3 cNm	5 cNm	SW-KS-113
GKS-050 M	≤ 1.1 mm	BIT-GKS-050 M-B	1.5	5	30	DW-1-S	-	-	0.5 cNm	1 cNm	SW-KS-080
GKS-075 M	≤ 1.1 mm	BIT-GKS-075 M-B	2.3	5	30	DW-1-S	-	-	0.5 cNm	1 cNm	SW-KS-075 G
GKS-075 M	≤ 1.5 mm	BIT-GKS-075 M	2.3	5	30	DW-1-S	-	-	0.5 cNm	1 cNm	SW-KS-075 G
GKS-087 M	≤ 1.1 mm	BIT-GKS-050 M-B	1.5	5	30	DW-1-S	-	-	0.5 cNm	1 cNm	SW-KS-050 G
GKS-098 M	≤ 3.1 mm	BIT-GKS-503 M-B	4.8	4.8	-	DW-20	DW-5-40	DW-20-120	10 cNm	20 cNm	SW-GKS
GKS-103 M	≤ 3.1 mm	BIT-GKS-503 M-B	4.8	4.8	-	DW-20	DW-5-40	DW-20-120	10 cNm	20 cNm	SW-KS-103
GKS-103 M	≤ 4.1 mm	BIT-GKS-503 M	5.5	6	27	DW-20	DW-5-40	DW-20-120	10 cNm	20 cNm	SW-KS-103
GKS-112 MD	≤ 2.0 mm	BIT-GKS-112 M-B-FP	2.8	5	30	DW-5-S	DW-5-40	-	3 cNm	5 cNm	SW-KS-112
GKS-112 M	≤ 2.0 mm	BIT-GKS-112 M-B	2.7	5	30	DW-5-S	DW-5-40	-	3 cNm	5 cNm	SW-KS-112
GKS-112 M	≤ 3.5 mm	BIT-GKS-112 M	4.3	6	27	DW-5-S	DW-5-40	-	3 cNm	5 cNm	SW-KS-112
GKS-113 M	≤ 3.0 mm	BIT-GKS-113 M-B	4.3	4.8	-	DW-20	DW-5-40	DW-20-120	10 cNm	20 cNm	SW-KS-113
GKS-113 M	≤ 4.2 mm	BIT-GKS-113 M	5.3	6	27	DW-20	DW-5-40	DW-20-120	10 cNm	20 cNm	SW-KS-113
GKS-113 M	≤ 8.0 mm	BIT-GKS-113 M-800	10	6	40	DW-20	DW-5-40	DW-20-120	10 cNm	20 cNm	SW-KS-113
GKS-204 M	≤ 2.0 mm	BIT-GKS-112 M-B	2.7	5	30	DW-5-S	DW-5-40	-	3 cNm	5 cNm	SW-KS-112
GKS-212 M	≤ 2.0 mm	BIT-GKS-212 M	2.7	6	26	DW-5-S	DW-5-40	-	3 cNm	5 cNm	SW-GKS
GKS-313 M	≤ 3.0 mm	BIT-GKS-113 M-B	4.8	4.8	-	DW-20	DW-5-40	DW-20-120	10 cNm	20 cNm	SW-KS-113
GKS-427 M	≤ 2.0 mm	BIT-GKS-112 M-B	2.7	5	30	DW-5-S	DW-5-40	-	3 cNm	5 cNm	SW-KS-112
GKS-500 M	Schlitz 0.5	BIT-GKS-500 M	3.5	6	27	DW-20	DW-5-40	DW-20-120	10 cNm	20 cNm	SW-GKS
GKS-503 M	≤ 3.1 mm	BIT-GKS-503 M-B	4.8	4.8	-	DW-20	DW-5-40	DW-20-120	10 cNm	20 cNm	SW-KS-103
GKS-503 M	≤ 4.1 mm	BIT-GKS-503 M	5.5	6	27	DW-20	DW-5-40	DW-20-120	10 cNm	20 cNm	SW-KS-103
GKS-746 M	≤ 2.0 mm	BIT-GKS-112 M-B	2.7	5	30	DW-5-S	DW-5-40	-	3 cNm	5 cNm	SW-KS-112
GKS-747 M	≤ 4.0 mm	BIT-GKS-747 M	5	6	28	DW-20	DW-5-40	DW-20-120	10 cNm	20 cNm	SW-KS-112
GKS-761 M	≤ 2.0 mm	BIT-GKS-112 M-B	2.7	5	30	DW-5-S	DW-5-40	-	3 cNm	5 cNm	SW-GKS
GKS-803 M	≤ 3.1 mm	BIT-GKS-503 M-B	4.8	4.8	-	DW-20	DW-5-40	DW-20-120	10 cNm	20 cNm	SW-KS-103
GKS-803 M	≤ 4.1 mm	BIT-GKS-503 M	5.5	6	27	DW-20	DW-5-40	DW-20-120	10 cNm	20 cNm	SW-KS-103
GKS-854 M	≤ 4.0 mm	BIT-HSS-150 M	5.5	6	28	DW-20	DW-5-40	DW-20-120	10 cNm	20 cNm	SW-GKS
GKS-899 M	≤ 1.5 mm	BIT-GKS-899 M-B	2.4	5	30	DW-3-S	-	-	2 cNm	3 cNm	SW-KS-100
GKS-899 M	≤ 2.0 mm	BIT-GKS-899 M	2.8	6	27	DW-3-S	-	-	2 cNm	3 cNm	SW-KS-100
GKS-913 M	≤ 3.0 mm	BIT-GKS-913 M-B	4.8	4.8	-	DW-5-S	DW-5-40	-	5 cNm	10 cNm	SW-KS-113
GKS-913 M	≤ 3.6 mm	BIT-GKS-913 M	5.3	6	27	DW-5-S	DW-5-40	-	5 cNm	10 cNm	SW-KS-113
GKS-967 M	≤ 1.3 mm	* BIT-GKS-967 M-B-K	5.3	5.3	30	DW-5-S	DW-5-40	-	3 cNm	5 cNm	SW-GKS
NEW HKF-617	-	BIT-HKF-617 06308 F	5	6	-	-	-	-	-	-	SW-KS-617

Torque Screwdriver with BIT tools

	Series	Plunger tip- Ø (Disk-Ø)	Bit-tool	Ø A	Ø B	C	Torque key			Recommend screw-in torque		Insertion tools for receptacles
				(mm)			pre-set	freely adjustable		min.	max.	
NEW	HKR-612 M	3/4 mm	BIT-HKR-612 SW8	10	6	-	-	-	DW-20-120	50 cNm		-
NEW	HKR-612 M	6 mm	BIT-HKR-612 SW10	12.5	6	-	-	-	DW-20-120	60 cNm		-
NEW	HKR-672 M	8/10/12 mm	Stecknuss. 14/16/17	-	-	-	-	-	-	2 Nm		-
NEW	HKR-694 M	4 mm	BIT-HKR-617 400 F	-	-	-	-	-	-	-	-	SW-KS-617
	HSS-118 M	≤ 2.0 mm	BIT-GKS-112 M-B	2.7	5	30	DW-5-S	DW-5-40	-	3 cNm	5 cNm	SW-KS-112
	HSS-118 M	≤ 3.5 mm	BIT-GKS-112 M	4.3	6	27	DW-5-S	DW-5-40	-	3 cNm	5 cNm	SW-KS-112
	HSS-120 M	≤ 3.0 mm	BIT-GKS-113 M-B	4.8	4.8	-	DW-20	DW-5-40	DW-20-120	10 cNm	20 cNm	SW-KS-113
	HSS-120 M	≤ 4.2 mm	BIT-GKS-113 M	5.3	6	27	DW-20	DW-5-40	DW-20-120	10 cNm	20 cNm	SW-KS-113
	HSS-150 M	≤ 3.0 mm	BIT-HSS-150 M-300	5.5	6	28	DW-20	DW-5-40	DW-20-120	10 cNm	20 cNm	SW-GKS
	HSS-150 M	≤ 4.0 mm	BIT-HSS-150 M	5.5	6	28	DW-20	DW-5-40	DW-20-120	10 cNm	20 cNm	SW-GKS
	HSS-520 M	≤ 3.0 mm	BIT-GKS-913 M-B	4.8	4.8	-	DW-5-S	DW-5-40	-	5 cNm	10 cNm	SW-KS-113
	HSS-520 M	≤ 3.6 mm	BIT-GKS-913 M	5.3	6	27	DW-5-S	DW-5-40	-	5 cNm	10 cNm	SW-KS-113
	HSS-552 M	≤ 4.0 mm	BIT-HSS-150 M	5.5	6	28	DW-20	DW-5-40	DW-20-120	10 cNm	20 cNm	SW-GKS
NEW	HSS-621 M	≤ 5.0 mm	BIT-HSS-621M-500	6.4	6	30	-	DW-5-40	DW-20-120	40 cNm		-
NEW	HSS-623 M	≤ 6.0 mm	BIT-HSS-623M-600	7.6	6	30	-	DW-5-40	DW-20-120	40 cNm		-
NEW	HSS-624 M	≤ 6.0 mm	BIT-HSS-623M-600	7.6	6	30	-	DW-5-40	DW-20-120	40 cNm		-
	HSS-827 M	≤ 2.0 mm	BIT-GKS-112 M-B	2.7	5	30	DW-5-S	DW-5-40	-	3 cNm	5 cNm	SW-KS-112
NEW	KK-541 M	-	BIT-KK-541 M	5	6	25	DW-5-S	DW-5-40	-	5 cNm		SW-KS-113
	PKS-171 M	≤ 1.6 mm	BIT-PKS-171 M-B	2.7	6	26	DW-3-S	-	-	2 cNm	3 cNm	SW-KS-100
	PKS-355 M	≤ 2.5 mm	BIT-PKS-465 M-B	4	4	-	DW-20	DW-5-40	DW-20-120	10 cNm	20 cNm	SW-KS-113
	PKS-388 M	≤ 3.7 mm	BIT-PKS-388 M-B	5	6	30	DW-20	DW-5-40	DW-20-120	10 cNm	20 cNm	SW-GKS
	PSK-350 M	≤ 2.5 mm	BIT-SKS-465 M-B	4	4	-	DW-20	DW-5-40	DW-20-120	10 cNm	20 cNm	SW-KS-113
NEW	SKS-115 M	≤ 3.0 mm	BIT-SKS-465 M	4	6	27	DW-5-S	DW-5-40	-	3 cNm	5 cNm	SW-KS-113
	SKS-215 M/MF	≤ 2.0 mm	BIT-GKS-112 M-B	2.7	5	30	DW-5-S	DW-5-40	-	3 cNm	5 cNm	SW-KS-112
	SKS-215 M/MF	≤ 3.5 mm	BIT-GKS-112 M	4.3	6	27	DW-5-S	DW-5-40	-	3 cNm	5 cNm	SW-KS-112
	SKS-435 M	≤ 3.1 mm	BIT-GKS-503 M-B	4.8	4.8	-	DW-20	DW-5-40	DW-20-120	10 cNm	20 cNm	SW-KS-103
	SKS-435 M	≤ 4.1 mm	BIT-GKS-503 M	5.5	6	27	DW-20	DW-5-40	DW-20-120	10 cNm	20 cNm	SW-KS-103
NEW	SKS-463 MF	≤ 2.5 mm	BIT-SKS-465 M-B	4	4	-	DW-5-S	DW-5-40	-	3 cNm	5 cNm	SW-KS-113
NEW	SKS-463 MF	≤ 3.0 mm	BIT-SKS-465 M	4	6	27	DW-5-S	DW-5-40	-	3 cNm	5 cNm	SW-KS-113
	SKS-465 MF	≤ 2.5 mm	BIT-SKS-465 M-B	4	4	-	DW-5-S	DW-5-40	-	3 cNm	5 cNm	SW-KS-113
	SKS-465 MF	≤ 3.0 mm	BIT-SKS-465 M	4	6	27	DW-5-S	DW-5-40	-	3 cNm	5 cNm	SW-KS-113
	SKS-465 SF	Schlitz 0.8	BIT-SKS-465 S	3	6	28	DW-5-S	DW-5-40	-	3 cNm	5 cNm	SW-KS-113
	T-112 M	≤ 2.0 mm	BIT-GKS-112 M-B	2.7	5	30	DW-5-S	DW-5-40	-	3 cNm	5 cNm	SW-KS-112
	T-112 M	≤ 3.5 mm	BIT-GKS-112 M	4.3	6	27	DW-5-S	DW-5-40	-	3 cNm	5 cNm	SW-KS-112
	T-113 M	≤ 3.0 mm	BIT-GKS-113 M-B	4.8	4.8	-	DW-20	DW-5-40	DW-20-120	10 cNm	20 cNm	SW-KS-113
	T-113 M	≤ 4.2 mm	BIT-GKS-113 M	5.3	6	27	DW-20	DW-5-40	DW-20-120	10 cNm	20 cNm	SW-KS-113
	T-113 M	≤ 5.0 mm	BIT-T-113 M	6	6	-	DW-20	DW-5-40	DW-20-120	10 cNm	20 cNm	SW-KS-113
NEW	T-785 M	≤ 5.0 mm	BIT-T-113 M	6	6	-	DW-20	DW-5-40	DW-20-120	10 cNm	20 cNm	SW-KS-113
	T-888 M	3.0 - 4.0 mm	BIT-T-888 M-3	3.5	6	23	DW-20	DW-5-40	DW-20-120	10 cNm	20 cNm	SW-KS-113
	T-888 M	4.0 - 4.7 mm	BIT-T-888 M	5	6	23	DW-20	DW-5-40	DW-20-120	10 cNm	20 cNm	SW-KS-113
	T-888 M	5.0 mm	BIT-T-912 M	2.6	6	23	DW-20	DW-5-40	DW-20-120	10 cNm	20 cNm	SW-KS-113
	T-899 M	≤ 1.5 mm	BIT-GKS-899 M-B	2.4	5	30	DW-3-S	-	-	2 cNm	3 cNm	SW-KS-100
	T-912 M	2.0 - 3.5 mm	BIT-T-912 M	2.6	6	23	DW-5-S	DW-5-40	-	3 cNm	5 cNm	SW-KS-112
	VF-3	≤ 2.1 mm	BIT-VF3 M-B	3.3	5	29	DW-5-S	DW-5-40	-	3 cNm	5 cNm	SW-GKS
	VF-3	≤ 3.0 mm	BIT-VF3 M	4	6	27	DW-5-S	DW-5-40	-	3 cNm	5 cNm	SW-GKS
	VF-4	≤ 2.5 mm	BIT-VF4 M-B	4	4	-	-	DW-5-40	-	5 cNm	10 cNm	SW-KS-103
	VF-4	≤ 4.0 mm	BIT-VF4 M	4	6	27	-	DW-5-40	-	5 cNm	10 cNm	SW-KS-103
	VF-5	≤ 3.0 mm	BIT-GKS-113 M-B	5.3	6	27	DW-20	DW-5-40	DW-20-120	5 cNm	20 cNm	-
NEW	VK-541 M	-	BIT-KK-541 M	5	6	25	DW-5-S	DW-5-40	-	5 cNm		-

* L_{total} = 47 mm

Ordering example

Bit-tool for screw-in probe:

BIT - GKS - 112 M - B

Handle without ratchet:

DW - S

Torque keys pre-set:

DW - 1 - S DW - 3 - S DW - 5 - S DW - 20

Torque keys freely adjustable:

DW - 5 - 40 DW - 20 - 120

INGUN Test Probes according to Series

Series	Page
NEW AW-KS-SET-ICT/CABLE	196
Bead Probe	48
NEW BIT tools	197
Contact terminals KT	191
NEW Dipole-GKS	152
DKS-050	44
DKS-075	44
DKS-100	44
NEW DPS-215	156
NEW DPS-465	157
DW tools	197/198
E-050	42
E-075	42
E-100	43
E-422	43
GKS-001	36
GKS-002	37
GKS-003	38
GKS-004	39
GKS-005	40
GKS-015	30
GKS-035	31
GKS-038	52
GKS-040	24
GKS-050	25
GKS-050 M	121
GKS-061	52
GKS-064	185
GKS-069	55
GKS-075	26/27
GKS-075 M	122
GKS-079	56
GKS-080	53
GKS-081	54
GKS-087 M	120
GKS-098	150
GKS-098 M	151
GKS-100	28/29
GKS-100 306 229 ...	190
GKS-100 307 150 ...	190
GKS-100 357 150 ...	190
GKS-101	35
GKS-102	66/193
GKS-103	70
GKS-103 M	129
GKS-112	61
GKS-112 M	125
GKS-112 MD	49
GKS-113	68
GKS-113 M	128
GKS-135	32
GKS-181	57
GKS-204	65
GKS-204 M	126
GKS-212 M	133
GKS-313 M	134
GKS-364	183
GKS-365	184
GKS-366	184
GKS-412	64

Series	Page
GKS-414	193
GKS-416	193
GKS-422	63
GKS-427 M	123
GKS-500 M	131
GKS-502	67
GKS-503	71
GKS-503 M	130
GKS-504	193
GKS-550	34
GKS-710	146
GKS-713	46
GKS-714	150
GKS-725	45
GKS-746 M	147
GKS-747 M	148
GKS-761 M	180
GKS-803 M	149
GKS-854	72
GKS-854 M	132
GKS-899 M	124
GKS-912	62
GKS-913	69
GKS-913 M	127
GKS-938	190
GKS-941	185
GKS-945	190
GKS-946	190
GKS-961	179
GKS-967/967 M	181
GKS-970	182
GKS-986	185
HFS test probes	152
HFS-010	158
HFS-110	159
NEW HKF-617	94
NEW HKR-612 M	96
NEW HKR-672 M	97
NEW HKR-694	98
HMS-075	192
HMS-100	192
HMS-422	192
HSS-005	90
HSS-118	78
HSS-118 M	79
HSS-120	80
HSS-120 M	81
HSS-150	82
HSS-150 M	83
HSS-150 H/MH	89
HSS-2259	99
HSS-2513	99
HSS-2516	99
HSS-2526	99
HSS-2532	99
HSS-520/520M	87
HSS-552 M	88
NEW HSS-621 M	84
NEW HSS-623 M	85
NEW HSS-624 M	92

Series	Page
HSS-827 M	86
NEW KK-541	95
KS-040 WL	33
KS-075 WL	33
KS-100 WL	33
KS-112	60
KS-550 WL	33
PKS accessories	174/175
PKS-171	163
PKS-171 M	170
PKS-200	164
PKS-220	165
PKS-299	166
PKS-300	167
PKS-355 M	171
PKS-388 M	172
PKS-399	168
PKS-420	169
PSK-350 M	173
NEW SKS-075	103
SKS-100	104
NEW SKS-115 M	113
SKS-215	105
SKS-215 M/MF	109
SKS-415	106
SKS-419	108
SKS-425	107
SKS-429	108
SKS-435 M	114
NEW SKS-463 MF	111
SKS-465 MF	110
SKS-465 SF	112
SW-GKS-xxx	196
SW-KS-xxx (-G)	196-198
SW-ZW-GKS-xxx	196
T-112 M	136/137
T-113 M	138/139
NEW T-785 M	140
T-888 M	138/139
T-899 M	135
T-912 M	136/137
Tools	194-198
VF 25	142
VF 3	143
VF 4	144
VF 5	145
NEW VK-541	93
VS-112	61
VS-112 M	125

Visit us on the internet under:
www.ingun.com

Headquarters

INGUN Germany

Subsidiaries

INGUN Benelux
INGUN China
INGUN India
INGUN Korea
INGUN Mexico
INGUN España
INGUN Switzerland
INGUN Türkiye
INGUN UK
INGUN USA

Europe

Austria
Benelux
Bosnia-Herzegovina
Croatia
Czech Republic
Denmark
Estonia
Finland
France
Germany
Hungary
Italy
Norway
Poland
Portugal
Romania
Serbia
Slovenia
Slovakia
Spain
Sweden
Switzerland
Turkey
United Kingdom

Asia

China
Hong Kong
India
Israel
Japan
Korea
Malaysia
Taiwan
Thailand
Vietnam

Africa

South Africa
Tunisia

Australia

Australia
New Zealand

America

Argentina
Brazil
Canada
Mexico
USA

The addresses of our international agencies can be found under www.ingun.com

ingun[®]

INGUN Prüfmittelbau GmbH

Max-Stromeyer-Straße 162

78467 Konstanz

Germany

Phone +49 7531 8105-0

Fax +49 7531 8105-65

info@ingun.com

www.ingun.com