



Features

- 1 kA, 8/20 μ s surge capability
- Low clamping voltage under surge
- Bidirectional TVS
- Excellent performance over temperature
- RoHS compliant* and halogen free**

Applications

- AC line protection
- Protection of power supplies used in exposed and harsh environments
- SPDs and dongles

PTVS1-xxxC-TH High Voltage, High Current TVS Diodes

General Information

The Model PTVS1-xxxC-TH high voltage, bidirectional TVS diodes are designed for use in AC line and high power DC bus clamping applications. These devices offer bidirectional port protection and are available with standoff voltage ratings of 66 V, 190 V and 380 V.

The devices are RoHS* compliant. They also meet IEC 61000-4-5 8/20 μ s current surge requirements.

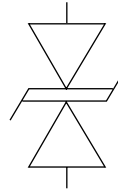

Agency Recognition

Description	
UL	File Number: E215609

Absolute Maximum Ratings (@ $T_A = 25^\circ\text{C}$ Unless Otherwise Noted)

Rating		Symbol	Value	Unit
Repetitive Standoff Voltage	PTVS1-066C-TH	V_{WM}	66	V
	PTVS1-190C-TH		190	
	PTVS1-380C-TH		380	
Peak Current Rating per 8/20 μ s IEC 61000-4-5		I_{PPM}	1	kA
Operating Junction Temperature Range		T_J	-55 to +125	$^\circ\text{C}$
Storage Temperature Range		T_S	-55 to +150	$^\circ\text{C}$
Lead Temperature, Soldering (10 s)			260	$^\circ\text{C}$

Electrical Characteristics (@ $T_A = 25^\circ\text{C}$ Unless Otherwise Noted)

Parameter	Test Conditions	Min.	Typ.	Max.	Unit	
I_D Standby Current	$V_D = V_{WM}$			10	μA	
$V_{(BR)}$ Breakdown Voltage	$I_{BR} = 10\text{ mA}$	PTVS1-066C-TH	71	75	80	V
		PTVS1-190C-TH	200	206	222	
		PTVS1-380C-TH	401	422	443	
V_C Clamping Voltage ⁽¹⁾	$I_{PP} = 1\text{ kA}$	PTVS1-066C-TH		86		V
		PTVS1-190C-TH		227		
		PTVS1-380C-TH		520		
$V_{(BR)}$ Temperature Coefficient			0.1		$\%/^\circ\text{C}$	
C Capacitance	F = 10 kHz, $V_d = 1\text{ V}_{rms}$	PTVS1-066C-TH		0.744		nF
		PTVS1-190C-TH		0.274		
		PTVS1-380C-TH		0.12		

⁽¹⁾ V_C measured at the time which is coincident with the peak surge current.

BOURNS®

Asia-Pacific: Tel: +886-2 2562-4117 • Email: asiacus@bourns.com

Europe: Tel: +36 88 885 877 • Email: eurocus@bourns.com

The Americas: Tel: +1-951 781-5500 • Email: americus@bourns.com

www.bourns.com



WARNING Cancer and Reproductive Harm - www.P65Warnings.ca.gov

* RoHS Directive 2015/863, Mar 31, 2015 and Annex.

** Bourns considers a product to be "halogen free" if (a) the Bromine (Br) content is 900 ppm or less; (b) the Chlorine (Cl) content is 900 ppm or less; and (c) the total Bromine (Br) and Chlorine (Cl) content is 1500 ppm or less.

Specifications are subject to change without notice.

Users should verify actual device performance in their specific applications.

The products described herein and this document are subject to specific legal disclaimers as set forth on the last page of this document, and at www.bourns.com/docs/legal/disclaimer.pdf.

Performance Graphs

V-I Characteristic

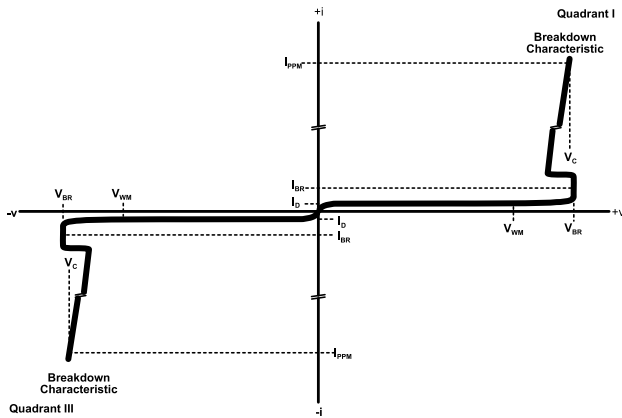

Typical V_{BR} vs. Junction Temperature

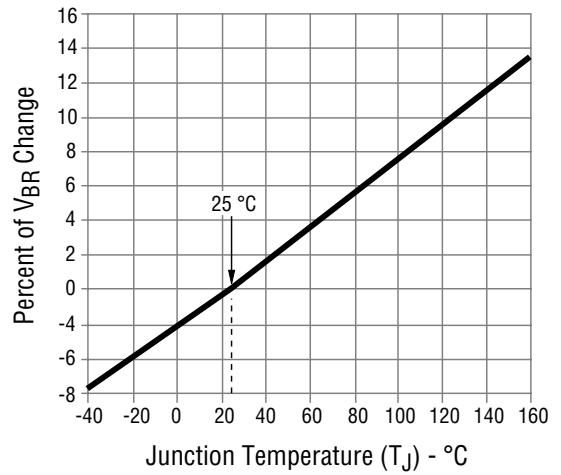

Typical Surge Current Derating

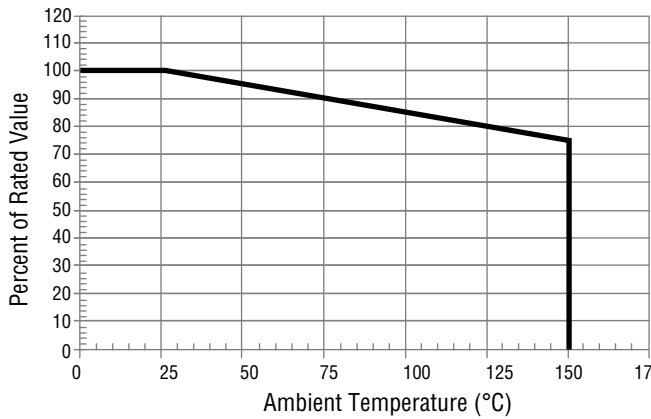

This graph shows the typical device surge current derating versus ambient temperature when subjected to the 8/20 μ s current waveform per the IEC 61000-4-5 specification. This device is not intended for continuous operation at temperatures above 125 °C.

Current 8/20 μ s Waveform per IEC 61000-4-5

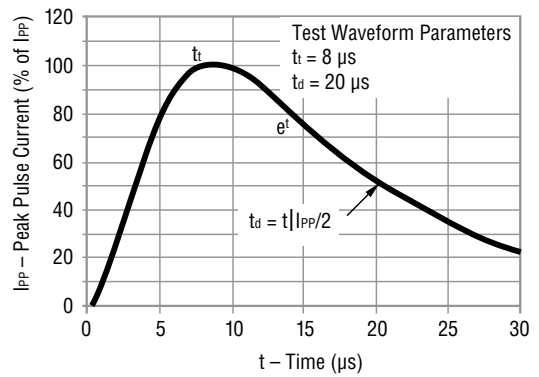

Typical Waveform Under Surge

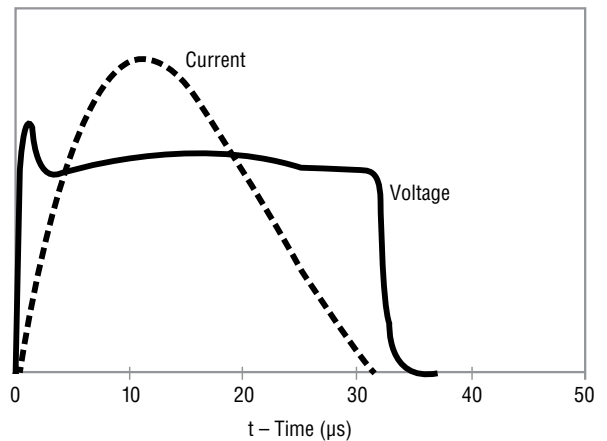

Specifications are subject to change without notice. Users should verify actual device performance in their specific applications. The products described herein and this document are subject to specific legal disclaimers as set forth on the last page of this document, and at www.bourns.com/docs/legal/disclaimer.pdf.

PTVS1-xxxC-TH High Voltage, High Current TVS Diodes



Product Dimensions

Epoxy encapsulation materials conform to UL 94V-0. Silver plated lead finish conforms to the solderability requirements of JESD22-B102, Pb free solder. Package dimensions are shown below:

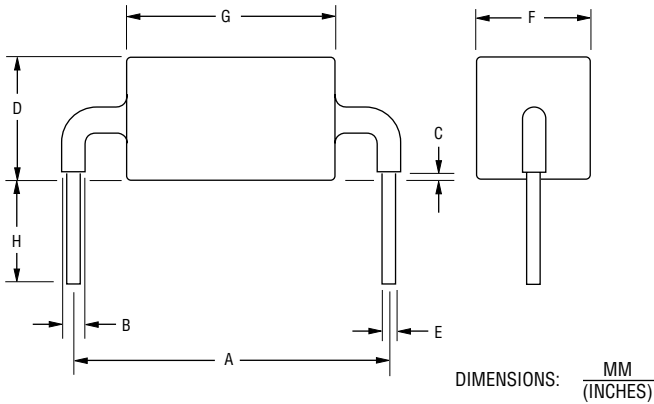

Dim.	PTVS1-066C-TH	PTVS1-190C-TH	PTVS1-380C-TH
A	$\frac{24.15 \pm 0.72}{(0.951 \pm 0.028)}$		
B	$\frac{2.40 \pm 0.50}{(0.094 \pm 0.020)}$	$\frac{2.00 \pm 0.50}{(0.079 \pm 0.020)}$	
C	$\frac{1.75 \pm 1.25}{(0.069 \pm 0.049)}$		$\frac{0.50 \pm 0.50}{(0.020 \pm 0.020)}$
D	$\frac{8.50}{(0.335)} \text{ Max.}$		$\frac{8.00}{(0.315)} \text{ Max.}$
E	$\frac{1.25 \pm 0.05}{(0.049 \pm 0.002)}$		
F	$\frac{7.00}{(0.276)} \text{ Max.}$		$\frac{8.00}{(0.315)} \text{ Max.}$
G	$\frac{6.00}{(0.236)} \text{ Max.}$	$\frac{10.00}{(0.394)} \text{ Max.}$	$\frac{14.50}{(0.571)} \text{ Max.}$
H	$\frac{6.00 \pm 1.00}{(0.236 \pm 0.039)}$		

Typical Part Marking

PTVS1-066C-TH1066
 PTVS1-190C-TH1190
 PTVS1-380C-TH1380

Environmental Specifications

Moisture Sensitivity Level1
 ESD Classification (HBM)3B

How to Order

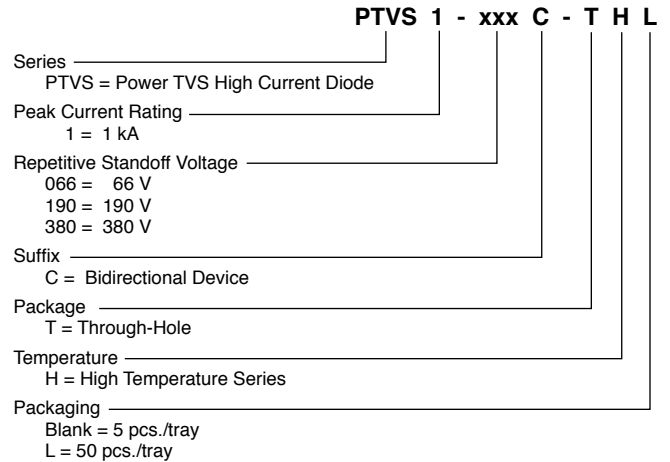

Specifications are subject to change without notice.

Users should verify actual device performance in their specific applications.

The products described herein and this document are subject to specific legal disclaimers as set forth on the last page of this document, and at www.bourns.com/docs/legal/disclaimer.pdf.

PTVS1-xxxC-TH High Voltage, High Current TVS Diodes



Packaging Information

The Model PTVS1-xxxC-THL is packaged in a 296 mm x 227 mm x 13 mm tray, 50 pcs. per tray.

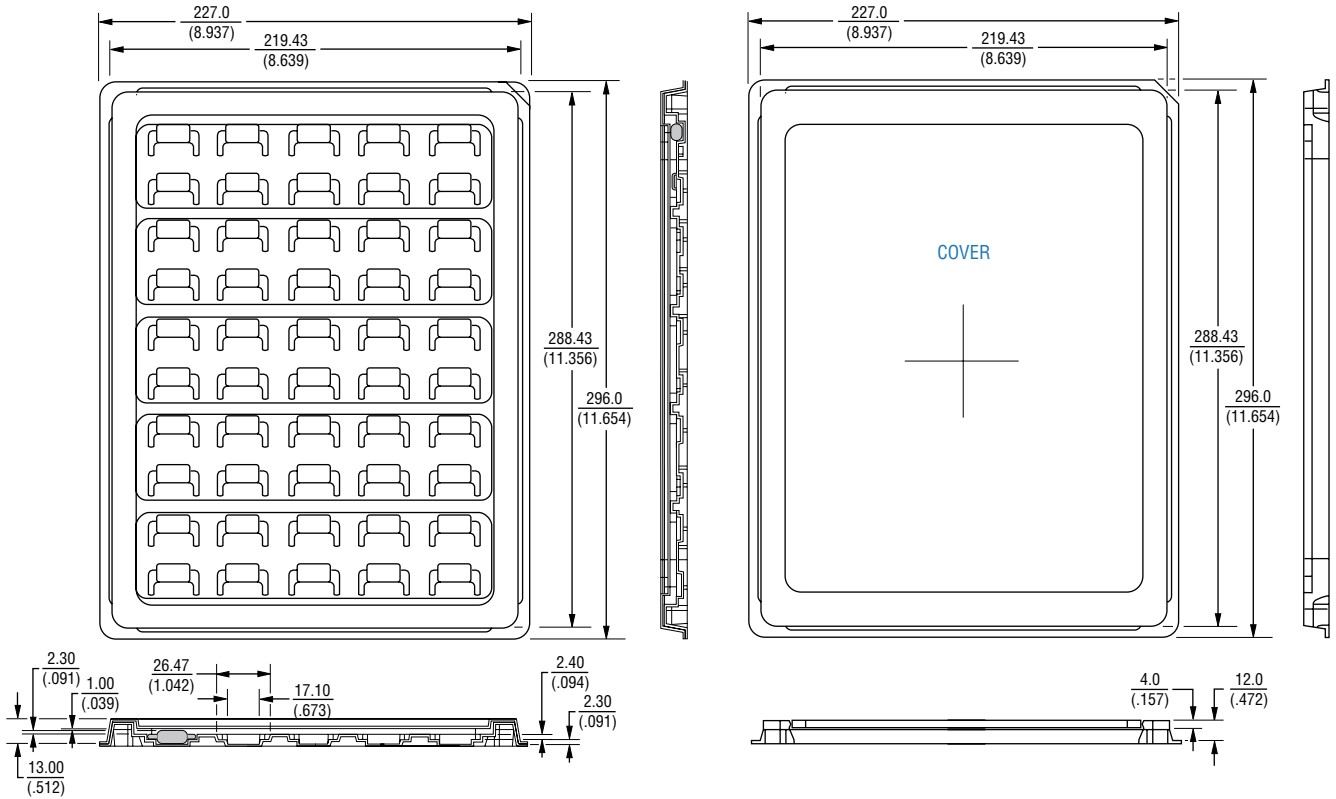

The Model PTVS1-xxxC-TH is packaged in a 190 mm x 110 mm x 17.4 mm tray, 5 pcs. per tray.

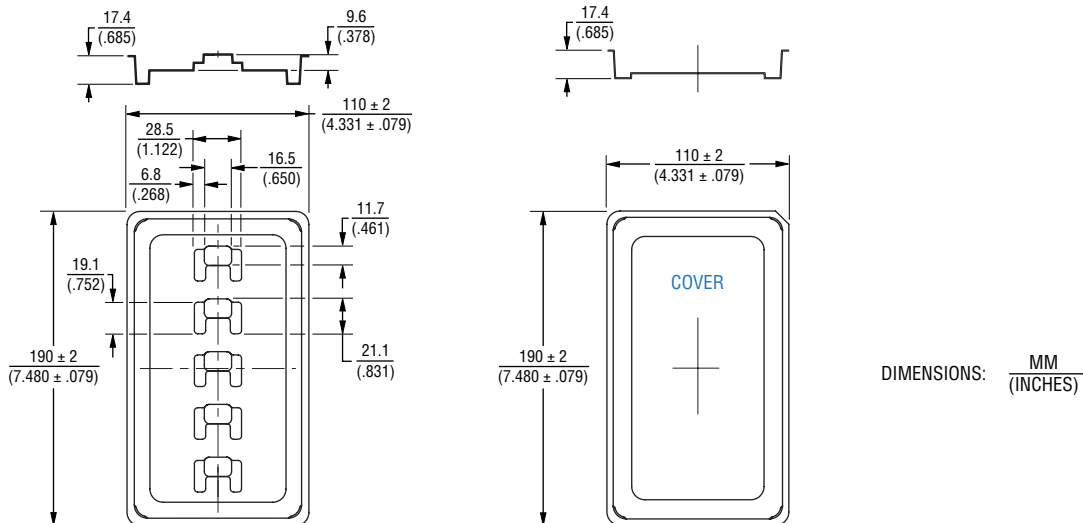

REV. 09/19

Specifications are subject to change without notice.

Users should verify actual device performance in their specific applications.

The products described herein and this document are subject to specific legal disclaimers as set forth on the last page of this document, and at www.bourns.com/docs/legal/disclaimer.pdf.

This legal disclaimer applies to purchasers and users of Bourns® products manufactured by or on behalf of Bourns, Inc. and its affiliates (collectively, "Bourns").

Unless otherwise expressly indicated in writing, Bourns® products and data sheets relating thereto are subject to change without notice. Users should check for and obtain the latest relevant information and verify that such information is current and complete before placing orders for Bourns® products.

The characteristics and parameters of a Bourns® product set forth in its data sheet are based on laboratory conditions, and statements regarding the suitability of products for certain types of applications are based on Bourns' knowledge of typical requirements in generic applications. The characteristics and parameters of a Bourns® product in a user application may vary from the data sheet characteristics and parameters due to (i) the combination of the Bourns® product with other components in the user's application, or (ii) the environment of the user application itself. The characteristics and parameters of a Bourns® product also can and do vary in different applications and actual performance may vary over time. Users should always verify the actual performance of the Bourns® product in their specific devices and applications, and make their own independent judgments regarding the amount of additional test margin to design into their device or application to compensate for differences between laboratory and real world conditions.

Unless Bourns has explicitly designated an individual Bourns® product as meeting the requirements of a particular industry standard (e.g., ISO/TS 16949) or a particular qualification (e.g., UL listed or recognized), Bourns is not responsible for any failure of an individual Bourns® product to meet the requirements of such industry standard or particular qualification. Users of Bourns® products are responsible for ensuring compliance with safety-related requirements and standards applicable to their devices or applications.

Bourns® products are not recommended, authorized or intended for use in nuclear, lifesaving, life-critical or life-sustaining applications, nor in any other applications where failure or malfunction may result in personal injury, death, or severe property or environmental damage. Unless expressly and specifically approved in writing by two authorized Bourns representatives on a case-by-case basis, use of any Bourns® products in such unauthorized applications might not be safe and thus is at the user's sole risk. Life-critical applications include devices identified by the U.S. Food and Drug Administration as Class III devices and generally equivalent classifications outside of the United States.

Bourns expressly identifies those Bourns® standard products that are suitable for use in automotive applications on such products' data sheets in the section entitled "Applications." Unless expressly and specifically approved in writing by two authorized Bourns representatives on a case-by-case basis, use of any other Bourns® standard products in an automotive application might not be safe and thus is not recommended, authorized or intended and is at the user's sole risk. If Bourns expressly identifies a sub-category of automotive application in the data sheet for its standard products (such as infotainment or lighting), such identification means that Bourns has reviewed its standard product and has determined that if such Bourns® standard product is considered for potential use in automotive applications, it should only be used in such sub-category of automotive applications. Any reference to Bourns® standard product in the data sheet as compliant with the AEC-Q standard or "automotive grade" does not by itself mean that Bourns has approved such product for use in an automotive application.

Bourns® standard products are not tested to comply with United States Federal Aviation Administration standards generally or any other generally equivalent governmental organization standard applicable to products designed or manufactured for use in aircraft or space applications. Bourns expressly identifies Bourns® standard products that are suitable for use in aircraft or space applications on such products' data sheets in the section entitled "Applications." Unless expressly and specifically approved in writing by two authorized Bourns representatives on a case-by-case basis, use of any other Bourns® standard product in an aircraft or space application might not be safe and thus is not recommended, authorized or intended and is at the user's sole risk.

The use and level of testing applicable to Bourns® custom products shall be negotiated on a case-by-case basis by Bourns and the user for which such Bourns® custom products are specially designed. Absent a written agreement between Bourns and the user regarding the use and level of such testing, the above provisions applicable to Bourns® standard products shall also apply to such Bourns® custom products.

Users shall not sell, transfer, export or re-export any Bourns® products or technology for use in activities which involve the design, development, production, use or stockpiling of nuclear, chemical or biological weapons or missiles, nor shall they use Bourns® products or technology in any facility which engages in activities relating to such devices. The foregoing restrictions apply to all uses and applications that violate national or international prohibitions, including embargos or international regulations. Further, Bourns® products and Bourns technology and technical data may not under any circumstance be exported or re-exported to countries subject to international sanctions or embargoes. Bourns® products may not, without prior authorization from Bourns and/or the U.S. Government, be resold, transferred, or re-exported to any party not eligible to receive U.S. commodities, software, and technical data.

To the maximum extent permitted by applicable law, Bourns disclaims (i) any and all liability for special, punitive, consequential, incidental or indirect damages or lost revenues or lost profits, and (ii) any and all implied warranties, including implied warranties of fitness for particular purpose, non-infringement and merchantability.

For your convenience, copies of this Legal Disclaimer Notice with German, Spanish, Japanese, Traditional Chinese and Simplified Chinese bilingual versions are available at:

Web Page: <http://www.bourns.com/legal/disclaimers-terms-and-policies>

PDF: <http://www.bourns.com/docs/Legal/disclaimer.pdf>