

Rotary Switches Type 01

With solder tags for cables

SW = Key spanner

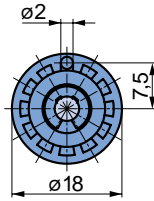
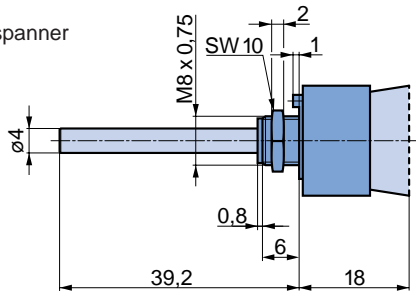

Front-panel cut out

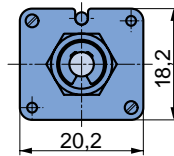
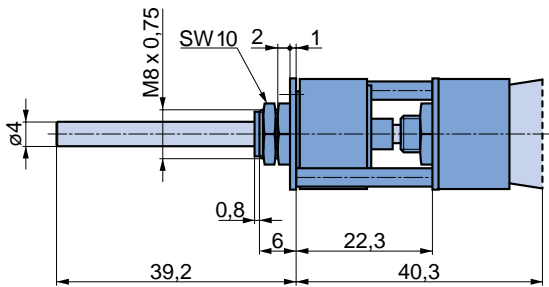
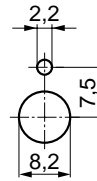

With pins for printed circuits

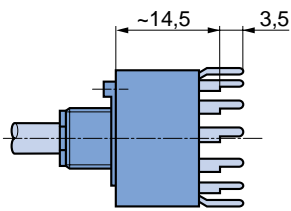

Drilling diagram for indexing angle 30°

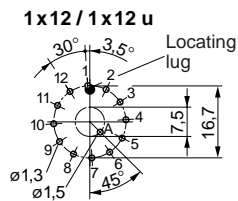

Drilling diagram view from the spindle end



Drilling diagram for indexing angle 36°

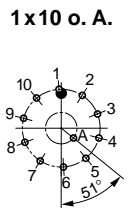
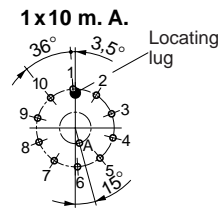

Drilling diagram for indexing angle 60°

1x11 / 1x11 u 2x6 / 2x6 u 4x3 / 4x3 u

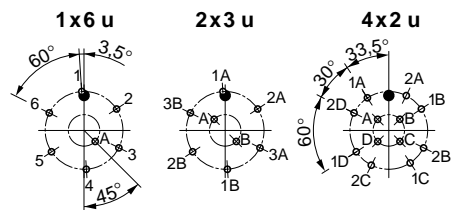
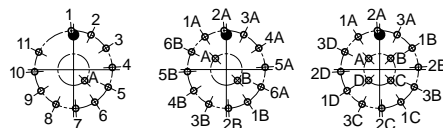

Description

Rotary switch with bridge contact principle

Overall diameter
18 mm

Central mounting

Threaded bushing

M 6 x 0,75 with 3 mm diameter shaft

M 8 x 0,75 with 4 mm diameter shaft

M10 x 0,75 with 6 mm diameter shaft

Indexing angle

30° = 12 switching positions

36° = 10 switching positions

60° = 6 switching positions

On switches with fixed end-stop, adjustable stops can be set, by means of a plastic pin, on any position between 2 and the maximum (to be ordered separately).

Number of poles per wafer
1, 2 or 4 (poles)

Switching mode
Shorting or non-shorting

Contact material
Silver and Gold plated 3 µm

Terminals
Solder lug or PCB mountable

1 mm = 0.04 inch

1 inch = 25.4 mm

Rotary Switches Type 01

Technical Data

Mechanical data

Mechanism indexing

30° = 12 positions
shorting or non-shorting

36° = 10 positions
shorting

60° = 6 positions
non-shorting

Switching torque with 1 wafer, 1 pole

Standard:

4 Ncm (~ 0,4 kp cm) ± 25%

Special:

2 Ncm (~ 0,2 kp cm) ± 25%

6 Ncm (~ 0,6 kp cm) ± 25%

Max. admissible tightening torque for nuts (shaft diameter 4 mm)

max. 300 Ncm (~ 30 kp cm)

Vibration resistance

10 – 2000 Hz / 10 g

Mechanical life

> 25 000 switching cycles

Temperature range

– 40 °C to + 85 °C

Material

Mechanism: plastic with metal
threaded bush
Shaft: stainless steel

Insulation material

Wafers: HF-ceramic
Rotor: polybutylene (PBTB)

Contact material

*Rivet (copper) and
segment (brass)*

Ag

10 µm silver coated, gold flashed
approx. 0,2 µm

Au 3 µm

3 µm gold plating on 3 µm nickel layer

Wiper (brass)

Ag

10 µm silver plated, gold flashed
approx. 0,2 µm

Au 3 µm

6 µm gold plated

Soldering

Handsoldering

Ceramic wafer ≤ 10 s / ≤ 350 °C

Machine soldering

Wave ≤ 5 s / ≤ 260 °C

Electrical data

Application data

Voltage < 42 V
Current < 2 A

Switching capacity with resistive load:

2 V / 1,0 A AC / DC

24 V / 0,5 A AC / DC

42 V / 0,4 A AC / DC

Switching mode

shorting or non-shorting

Contact and lead resistance

< 10 mΩ in new condition

Insulation resistance measured with 500 V DC, for 1 min

> 10¹¹ Ω contact to contact

> 10¹¹ Ω contact to earth

Capacitance

1 pF contact to contact

Test voltage at 50 Hz and 60% relative humidity, for 1 min

750 rms contact to contact

750 rms contact to earth

500 rms with more than one circuit

Special Options to Rotary Switches Type 01

Ordering an option

To order a special option please use the order form.
Please specify your requirements and fax it to your local contact or to Elma.

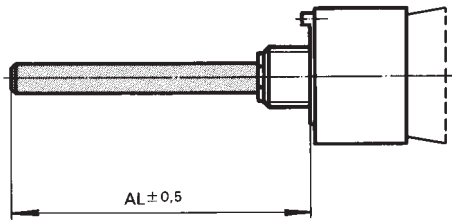

Special shaft length

To order, state the shaft length AL as shown in diagram, measured from mounting face.
Please specify shaft length on the order form.

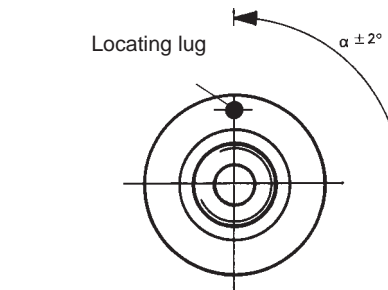

Angle in ° from locating lug.
Switch on position 1

Special types of shaft

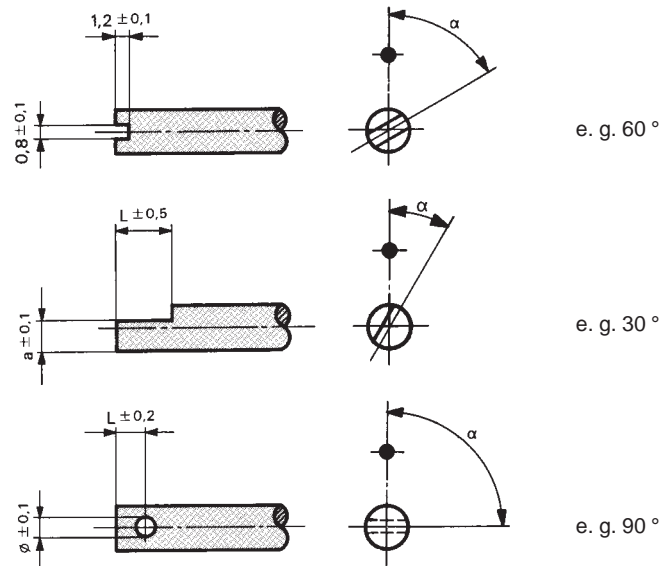

Specially machined shafts are available. Please specify dimensions on page 57.

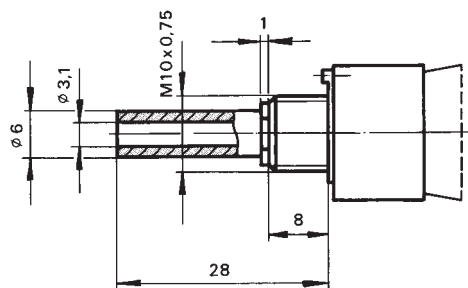

Hollow shaft

Hollow shaft to allow concentric operation of either two switches or, for example, a switch and a potentiometer, the inner shaft (φ 3 mm) must be ordered separately.
Please complete order form.

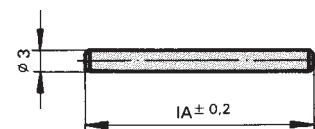

Inner shaft

Must be ordered separately for switches with hollow shaft. Please complete order form..

Special Options to Rotary Switches Type 01

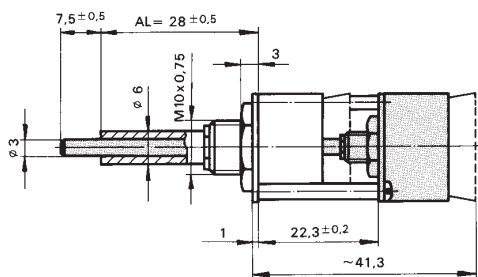

Switches with 2 drive shafts

It is possible for two switches to be operated individually by concentric shafts on the same mounting. When ordering, the type number of each switch should be given and specified on order form.

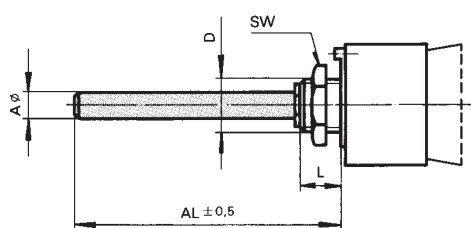

Special shaft diameters

Type 01 switches are also available with the following shaft diameters:

Aø	D	SW	L	AL Standard	AL max.
3 mm	M 6 x 0,75	10 mm	6,0 mm	59 mm	80 mm
6 mm	M 10 x 0,75	14 mm	8,0 mm	28 mm	28 mm

Please complete order form..

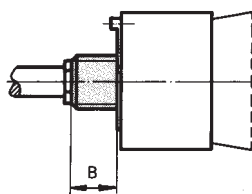

Shortened bushing

Please state dimension B (Dimension B = min. 3 mm)
Specify dimensions on order form.

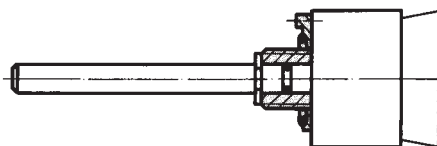

Waterproof version

With 4 mm ø shaft only; to prevent water penetrating behind the front panel and into the mechanism. Waterproof up to 1 bar (IP 68)
Please complete order form.

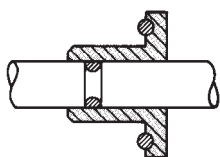

Front-panel cut out



Ordering Code to Rotary Switches Type 01

This code specifies the function of the switch

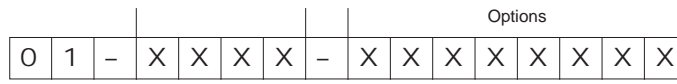

Switch Type

Number of wafers

Number of poles

Free character

0 = Ag shorting
 1 = Ag non-shorting
 3 = Au 3 µm shorting
 4 = Au 3 µm non-shorting

Md = Switching torque
 AL = Shaft length
 BG = Stopped
 GS = With solder pins for PCB mounting
 WD = Waterproof version

0 = shaft 4 mm Standard
 M = shaft 3 mm
 N = shaft 6 mm

00 = Standard
 11 = BG 11 Pos.
 10 = BG 10 Pos.
 09 = BG 9 Pos.
 08 = BG 8 Pos.
 07 = BG 7 Pos.
 06 = BG 6 Pos.
 05 = BG 5 Pos.
 04 = BG 4 Pos.
 03 = BG 3 Pos.
 02 = BG 2 Pos.

000 = Standard AL 59 mm = 3 mm shaft
 = Standard AL 39,2 mm = 4 mm shaft
 = Standard AL 28 mm = 6 mm shaft
 = XXX = AL (z. B. 185 = 18,5 mm)

00 = Standard
 20 = GS
 30 = WD
 70 = GS/WD

- = Standard Md 4 Ncm
 M = Md 2 Ncm
 N = Md 6 Ncm

1 mm = 0.04 inch 1 inch = 25.4 mm