

OMRON

DC Power Relays

G9EA/G9EB/G9EC

DC Control in a Relay

A Leader in Clean Energy with Compact, Quiet, Energy-efficient Designs



G9EB



G9EA



G9EC



Compact models added to further expand Series

DC POWER RELAY

DC Power Relays that Interrupt High-capacity DC Loads and High-voltage DC Circuits in a Compact, Low-noise Design

In the endeavors to prevent global warming, air pollution, and the depletion of oil resources, much attention is being given to increasing the efficiency of AC-to-DC power conversion and distributed power generation. DC contactors and circuit-breakers, however, are disadvantaged by their noise and bulk.

OMRON has improved on the standard DC circuit that switches using a contactor or circuit-breaker by developing the G9EA/G9EB/G9EC DC Power Relay Series. These Relays enable switching high-voltage and high-capacity loads. The switch's gas-filled construction allows a considerable reduction in the relay switch size, while also lowering the operating noise during load switching. Furthermore, the new design has decreased the power consumption of the coil and achieved long-term contact stability.



Features

OMRON DC Power Switching Technologies

- Sealed switching
- Gas-cooled arc
- Magnetic arc control

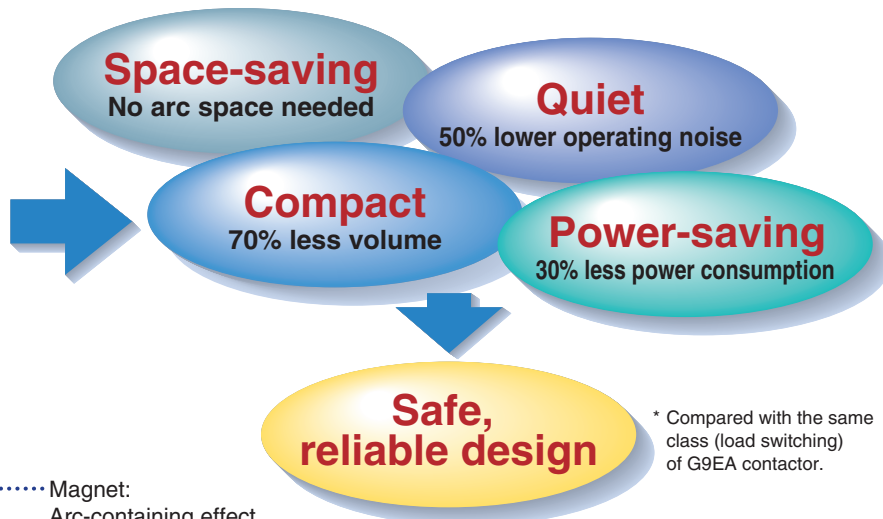

Gas-filled construction (contactor):
Arc-cooling effect

Magnet:
Arc-containing effect

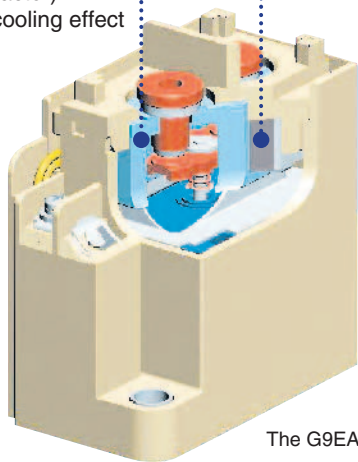

The G9EA is shown.

Applications

Smaller and quieter for a variety of DC applications

Automobiles

Hybrid cars, fuel-cell cars, compact electric passenger vehicles, etc.

Special Vehicles

Battery-operated golf carts, forklifts, AGV (automated guided vehicles), battery-powered agricultural equipment, etc.

Electric Power and Distributed Power Generation

Wind-powered or photovoltaic power generation systems, fuel-cell cogeneration systems, etc.

General-purpose Industrial Equipment

Inverters, UPS, power supplies, robots, machining centers, elevators, escalators, medical equipment, testing equipment (batteries, fuel cells), etc.

DC Power Relays Selection Guide

OMRON DC Power Relays Interrupt High-capacity DC Loads while Enabling Compact, Low-noise, Safe Applications

List of DC Power Relays

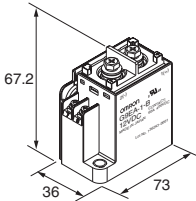
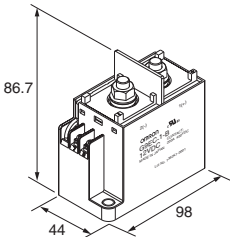
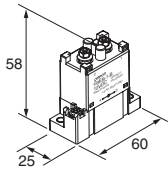
Model		G9EA		G9EC	G9EB	
		G9EA-1(-B)	G9EA-1(-B)-CA	G9EC-1(-B)	G9EB-1-B	
Classification		Switching/current conduction	High-current conduction	Switching/current conduction	Switching/current conduction	
Appearance						
Features		Standard model Compact, carries/switches 400-V, 60-A loads	Carries 100 A Low contact resistance when carrying current	Largest capacity in series Carries/switches 400-V, 200-A loads	Smallest in series Carries/switches 250-V, 25-A loads	
Contacts	Contact form	SPST-NO				
	Contact structure	Double-break, single				
	Contact resistance	30 mΩ max. (0.6 mΩ typical)	10 mΩ max. (0.3 mΩ typical)	30 mΩ max. (0.2 mΩ typical)	30 mΩ max.	
	Switching voltage drop	0.1 V max. (for a carry current of 60 A)	0.1 V max. (for a carry current of 100 A)	0.1 V max. (for a carry current of 200 A)	0.1 V max. (for a carry current of 25 A)	
	Electrical endurance	120 VDC, 100 A, 3,000 operations min.	400 VDC, 30 A, 1,000 operations min.	400 VDC, 200 A, 3,000 operations min.	250 VDC, 25 A, 30,000 operations min.	
		400 VDC, 60 A, 3,000 operations min.	120 VDC, 30 A, 2,500 operations min.	---	---	
		400 VDC, 30 A, 30,000 operations min.	---	---	---	
	Maximum switching current	100 A	30 A	200 A	25 A	
	Rated carry current	200			200 A	
		180				
		160				
		140				
		120				
100			100 A			
80		60 A				
60						
40						
20				25 A		
Short-time carry current	100 A (10 min)	150 A (10 min)	300 A (15 min)	50 A (5 min), 40 A (10 min)		
Maximum interruption current	600 A at 300 VDC (5 times)	---	1,000 A at 400 VDC (10 times)	100 A at 250 VDC (5 times)		
Overload interruption	180 A at 400 VDC (100 times min.)	100 A at 120 VDC (150 times min.)	700 A at 400 VDC (40 times min.)	50 A at 250 VDC (50 times min.)		
Reverse polarity interruption	-60 A at 200 VDC (1,000 times min.)	---	-200 A at 200 VDC (1,000 times min.)	---		
Coil	Rated voltage	12, 24, 48, 60, and 100 VDC				
	Power consumption	Approx. 5 to 5.4 W		Approx. 11 W	Approx. 2 W	
Mechanical endurance		200,000 operations min.			100,000 operations min.	

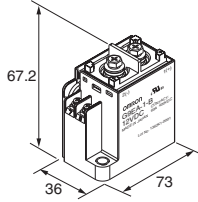
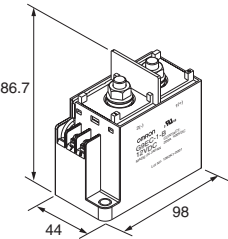
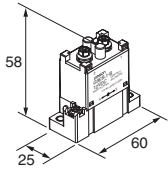
Model	G9EA		G9EC	G9EB
	G9EA-1(-B)	G9EA-1(-B)-CA	G9EC-1(-B)	G9EB-1-B
Classification	Switching/current conduction	High-current conduction	Switching/current conduction	Switching/current conduction
Appearance				
Features	Standard model Compact, carries/switches 400-V, 60-A loads	Carries 100 A Low contact resistance when carrying current	Largest capacity in series Carries/switches 400-V, 200-A loads	Smallest in series Carries/switches 250-V, 25-A loads
Insulation resistance (See note 2.)	Between coil and contacts	1,000 MΩ min.		
	Between contacts of the same polarity	1,000 MΩ min.		
Dielectric strength	Between coil and contacts	2,500 VAC, 1 min		
	Between contacts of the same polarity	2,500 VAC, 1 min		
Impulse withstand voltage (See note 3.)	4,500 V			
Ambient operating temperature	-40 to 70°C (with no icing or condensation)		-40 to 50°C (with no icing or condensation)	-40 to 70°C (with no icing or condensation)
Ambient operating humidity	5% to 85%			
Terminals	Screw terminals	Yes	Yes	Yes
	Lead wire output	Yes	Yes	---
Weight	Approx. 310 g		Approx. 560 g	Approx. 135 g
Refer to page	5		11	17

Note: 1. The insulation resistance was measured with a 500-VDC megohmmeter.

2. The impulse withstand voltage was measured with a JEC-212 (1981) standard impulse voltage waveform (1.2 × 50 μs).

DC Power Relays (60-A, 100-A Models) G9EA-1

DC Power Relays Capable of Interrupting High-voltage, High-current Loads

- A compact relay (73 x 36 x 67.2 mm (L x W x H)) capable of switching 400-V 60-A DC loads. (Capable of interrupting 600 A at 300 VDC max.)
- The switching section and driving section are gas-injected and hermetically sealed, allowing these compact relays to interrupt high-capacity loads. The sealed construction also requires no arc space, saves space, and helps ensure safe applications.
- Downsizing and optimum design allow no restrictions on the mounting direction.
- Terminal Cover and DIN Track Adapters are also available for industrial applications.
- UL/CSA standard UL508 approved.

Note: Refer to *Precautions* on page 22.



Model Number Structure

Model Number Legend

G9EA-□-□-□-□
1 2 3 4

1. Number of Poles

1: 1 pole

2. Contact Form

Blank: SPST-NO

3. Coil Terminals

B: M3.5 screw terminals

Blank: Lead wire output

4. Special Functions

CA: High-current conduction (100 A)

Ordering Information

List of Models

Models	Terminals		Contact form	Rated coil voltage	Model
	Coil terminals	Contact terminals			
Switching/current conduction models	Screw terminals (See note 2.)	Screw terminals (See note 1.)	SPST-NO	12 VDC	G9EA-1-B
	Lead wires			24 VDC	G9EA-1
High-current conduction models	Screw terminals (See note 2.)	Lead wires		48 VDC	G9EA-1-B-CA
	Lead wires			60 VDC	G9EA-1-CA
			100 VDC		

Note: 1. Two M5 screws are provided for the contact terminal connection.

2. Two M3.5 screws are provided for the coil terminal connection.

Specifications

■ Ratings

Coil

Rated voltage	Rated current	Coil resistance	Must-operate voltage	Must-release voltage	Maximum voltage (See note 3.)	Power consumption
12 VDC	417 mA	28.8 Ω	75% max. of rated voltage	8% min. of rated voltage	130% of rated voltage (at 23°C within 10 minutes)	Approx. 5 W
24 VDC	208 mA	115.2 Ω				
48 VDC	102 mA	469.3 Ω				
60 VDC	86.2 mA	695.7 Ω				Approx. 5.2 W
100 VDC	53.6 mA	1,864 Ω				Approx. 5.4 W

- Note:** 1. The figures for the rated current and coil resistance are for a coil temperature of 23°C and have a tolerance of ±10%.
 2. The figures for the operating characteristics are for a coil temperature of 23°C.
 3. The figure for the maximum voltage is the maximum voltage that can be applied to the relay coil.

Contacts

Item	Resistive load	
	G9EA-1(-B)	G9EA-1(-B)-CA
Rated load	60 A at 400 VDC, 100 A at 120 VDC	30 A at 400 VDC
Rated carry current	60 A	100 A
Maximum switching voltage	400 V	400 V
Maximum switching current	100 A	30 A

■ Characteristics

Item	G9EA-1(-B)	G9EA-1(-B)-CA
Contact resistance (See note 2.)	30 mΩ max. (0.6 mΩ typical)	10 mΩ max. (0.3 mΩ typical)
Contact voltage drop	0.1 V max. (for a carry current of 60 A)	0.1 V max. (for a carry current of 100 A)
Operate time	50 ms max.	
Release time	30 ms max.	
Insulation resistance (See note 3.)	Between coil and contacts	1,000 MΩ min.
	Between contacts of the same polarity	1,000 MΩ min.
Dielectric strength	Between coil and contacts	2,500 VAC, 1 min
	Between contacts of the same polarity	2,500 VAC, 1 min
Impulse withstand voltage (See note 4.)	4,500 V	
Vibration resistance	Destruction	10 to 55 to 10 Hz, 0.75-mm single amplitude (Acceleration: 2.94 to 88.9 m/s ²)
	Malfunction	10 to 55 to 10 Hz, 0.75-mm single amplitude (Acceleration: 2.94 to 88.9 m/s ²)
Shock resistance	Destruction	490 m/s ²
	Malfunction	196 m/s ²
Mechanical endurance (See note 5.)	200,000 ops. min.	
Electrical endurance (See note 6.)	120 VDC, 100 A, 3,000 ops. min.	400 VDC, 30 A, 1,000 ops. min.
	400 VDC, 60 A, 3,000 ops. min.	120 VDC, 30 A, 2,500 ops. min.
	400 VDC, 30 A, 30,000 ops. min.	---
Short-time carry current	100 A (10 min)	150 A (10 min)
Maximum interruption current	600 A at 300 VDC (5 times)	
Overload interruption	180 A at 400 VDC (100 times min.)	100 A at 120 VDC (150 times min.)
Reverse polarity interruption	-60 A at 200 VDC (1,000 times min.)	
Ambient operating temperature	-40 to 70°C (with no icing or condensation)	
Ambient operating humidity	5% to 85%	
Weight	Approx. 310 g	

- Note:** 1. The above values are initial values at an ambient temperature of 23°C unless otherwise specified.
 2. The contact resistance was measured with 1 A at 5 VDC using the voltage drop method.
 3. The insulation resistance was measured with a 500-VDC megohmmeter.
 4. The impulse withstand voltage was measured with a JEC-212 (1981) standard impulse voltage waveform (1.2 × 50 μs).
 5. The mechanical endurance was measured at a switching frequency of 3,600 operations/hr.
 6. The electrical endurance was measured at a switching frequency of 60 operations/hr.

Engineering Data

■ G9EA-1(-B) Switching/Current Conduction Models

Maximum Switching Capacity

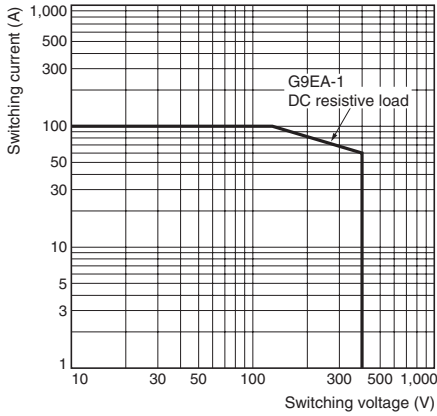

Electrical Endurance (Switching Performance)

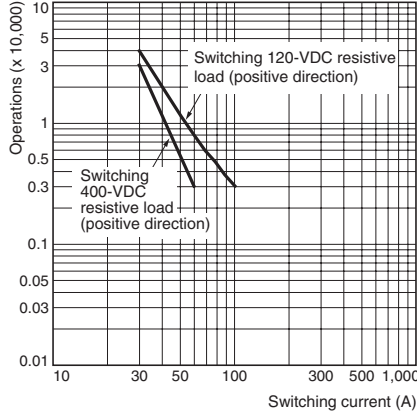

Electrical Endurance (Interruption Performance)

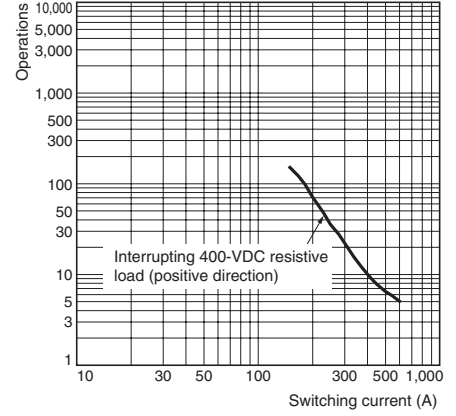

Carry Current vs Energizing Time

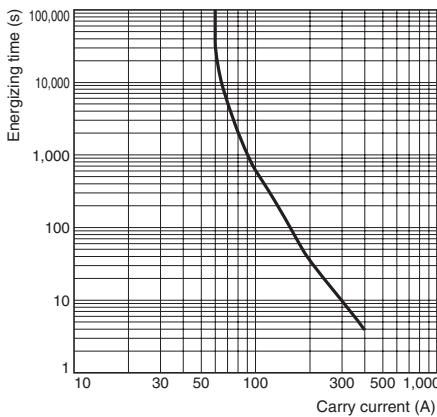

■ G9EA-1(-B)-CA High-current Conduction Models

Maximum Switching Capacity

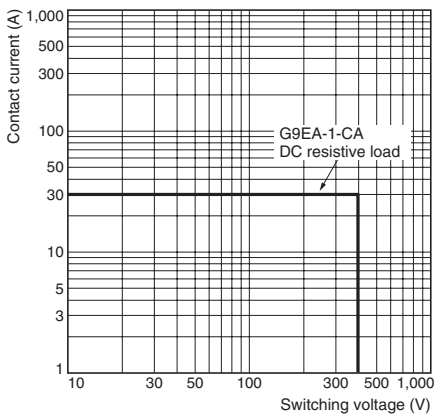

Electrical Endurance (Switching Performance)

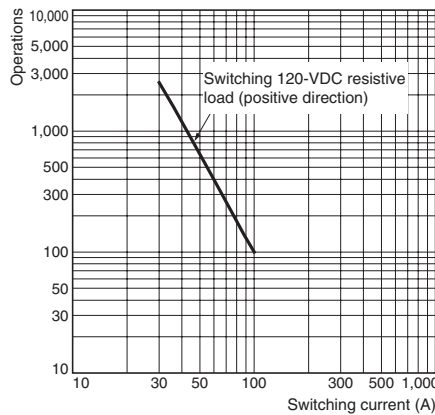

Carry Current vs Energizing Time

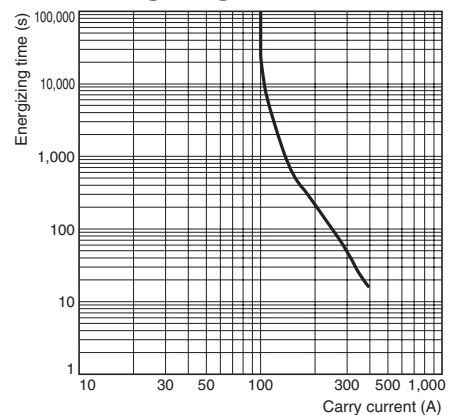

■ All G9EA-1 Models

Must-operate Voltage and Must-release Voltage Distributions

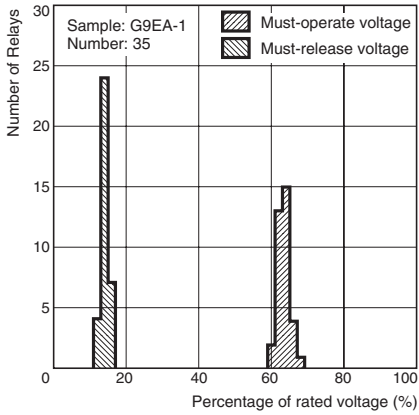

Time Characteristic Distributions

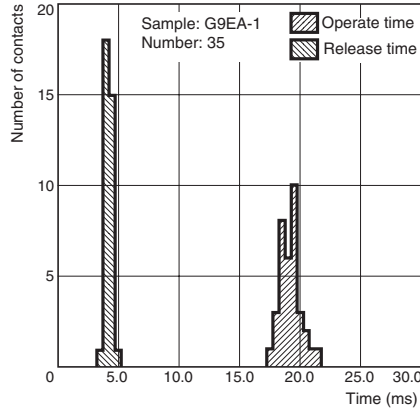

Vibration Malfunction

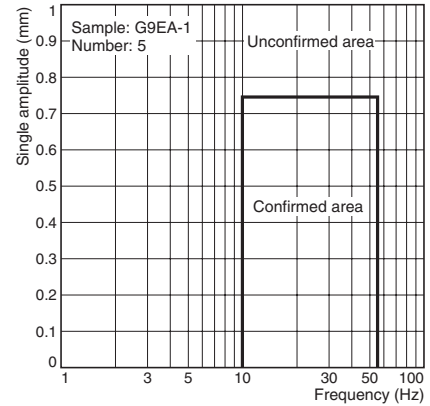

Vibration Resistance

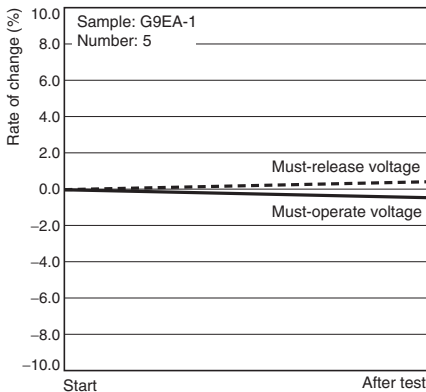

Characteristics were measured after applying vibration at a frequency of 10 to 55 Hz (single amplitude of 0.75 mm) to the test piece (not energized) for 2 hours each in 3 directions. The percentage rate of change is the average value for all of the samples

Shock Malfunction

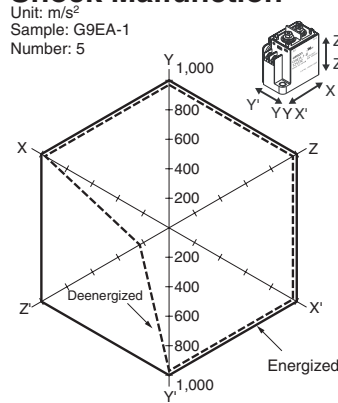

The value at which malfunction occurred was measured after applying shock to the test piece 3 times each in 6 directions along 3 axes.

Shock Resistance

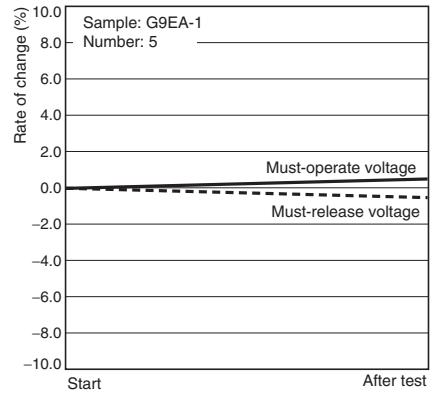

Characteristics were measured after applying a shock of $490 m^2/s$ to the test piece 3 times each in 6 directions along 3 axes. The percentage rate of change is the average value for all of the samples.

Dimensions

Note: All units are in millimeters unless otherwise indicated.

Models with Screw Terminals

G9EA-1-B(-CA)

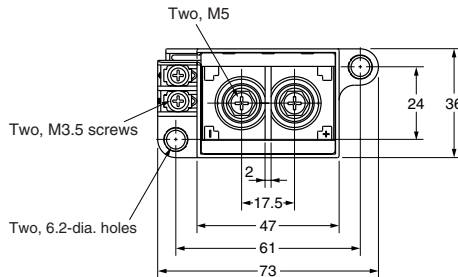
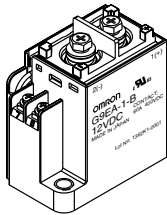

Terminal Arrangement/
Internal Connections
(TOP VIEW)

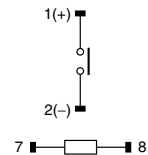

Note: Be sure to connect terminals with the correct polarity. Coils do not have polarity.

Mounting Hole Dimensions
(TOP VIEW)

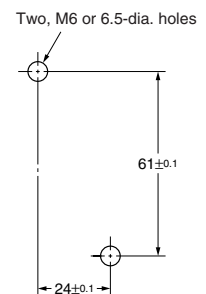

Dimension (mm)	Tolerance (mm)
10 or lower	±0.3
10 to 50	±0.5
50 or higher	±1

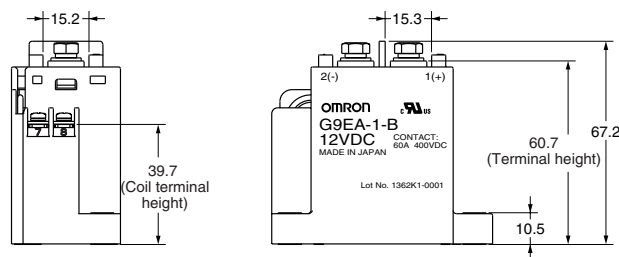

Models with Lead Wires

G9EA-1(-CA)

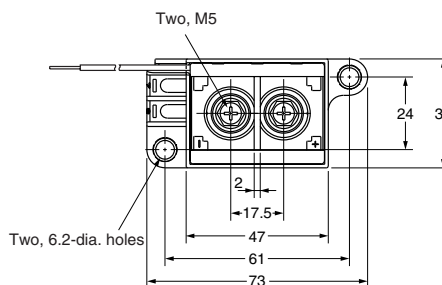
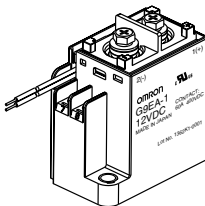

Terminal Arrangement/
Internal Connections
(TOP VIEW)

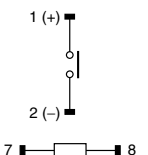

Note: Be sure to connect terminals with the correct polarity. Coils do not have polarity.

Mounting Hole Dimensions
(TOP VIEW)

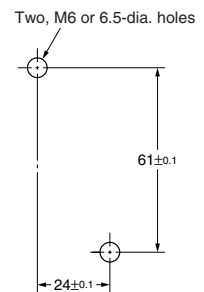

Dimension (mm)	Tolerance (mm)
10 or lower	±0.3
10 to 50	±0.5
50 or higher	±1

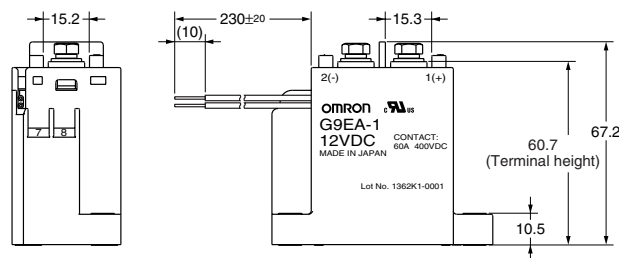

Options

Terminal Cover

P9EA-C

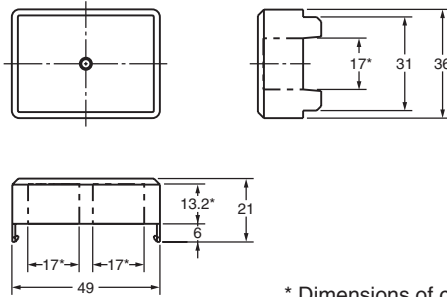
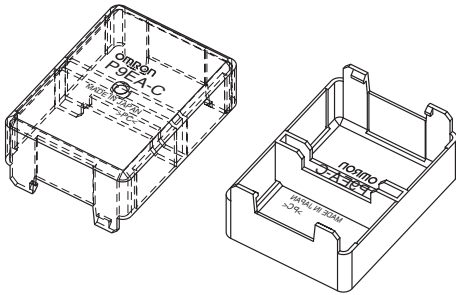

Note: Be sure to remove the cutouts for wiring that are located in the wiring outlet direction before installing the Terminal Cover.

Dimension (mm)	Tolerance (mm)
10 or lower	±0.3
10 to 50	±0.5
50 or higher	±1

* Dimensions of cutouts for wiring.

DIN Track Adapter

P9EA-D

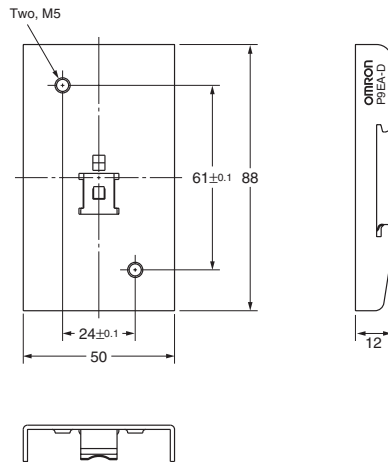
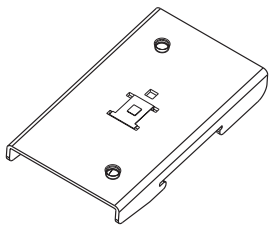

Dimension (mm)	Tolerance (mm)
10 or lower	±0.3
10 to 50	±0.5
50 or higher	±1

DC Power Relays (200-A Models) G9EC-1

DC Power Relays Capable of Interrupting High-voltage, High-current Loads

- A compact relay (98 x 44 x 86.7 mm (L x W x H)) capable of switching 400-V 200-A DC loads. (Capable of interrupting 1,000 A at 400 VDC max.)
- The switching section and driving section are gas-injected and hermetically sealed, allowing these compact relays to interrupt high-capacity loads. The sealed construction also requires no arc space, saves space, and helps ensure safe applications.
- Downsizing and optimum design allow no restrictions on the mounting direction.
- Terminal Cover is also available for industrial applications.
- UL/CSA standard UL508 approved.

Note: Refer to *Precautions* on page 22.



Model Number Structure

Model Number Legend

G9EC-□-□-□-□
 1 2 3 4

- 1. Number of Poles**
1: 1 pole
- 2. Contact Form**
Blank: SPST-NO
- 3. Coil Terminals**
B: M3.5 screw terminals (standard)
Blank: Lead wire output
- 4. Special Functions**

Ordering Information

List of Models

Models	Terminals		Contact form	Coil rated voltage	Model
	Coil terminals	Contact terminals			
Switching/current conduction models	Screw terminals (See note 2.)	Screw terminals (See note 1.)	SPST-NO	12 VDC 24 VDC 48 VDC 60 VDC 100 VDC	G9EC-1-B
	Lead wire				G9EC-1

- Note:** 1. Two M8 nuts are provided for the contact terminal connection.
2. Two M3.5 screws are provided for the coil terminal connection.

Specifications

■ Ratings

Coil

Rated voltage	Rated current	Coil resistance	Must-operate voltage	Must-release voltage	Maximum voltage (See note 3.)	Power consumption
12 VDC	938 mA	12.8 Ω	75% max. of rated voltage	8% min. of rated voltage	110% of rated voltage (at 23°C within 10 minutes)	Approx. 11 W
24 VDC	469 mA	51.2 Ω				
48 VDC	234 mA	204.8 Ω				
60 VDC	188 mA	320.0 Ω				
100 VDC	113 mA	888.9 Ω				

- Note:**
1. The figures for the rated current and coil resistance are for a coil temperature of 23°C and have a tolerance of ±10%.
 2. The figures for the operating characteristics are for a coil temperature of 23°C.
 3. The figure for the maximum voltage is the maximum voltage that can be applied to the relay coil.

Contacts

Item	Resistive load
	G9EC-1(-B)
Rated load	200 A at 400 VDC
Rated carry current	200 A
Maximum switching voltage	400 V
Maximum switching current	200 A

■ Characteristics

Item	G9EC-1(-B)	
Contact resistance (See note 2.)	30 mΩ max. (0.2 mΩ typical)	
Contact voltage drop	0.1 V max. (for a carry current of 200 A)	
Operate time	50 ms max.	
Release time	30 ms max.	
Insulation resistance (See note 3.)	Between coil and contacts	1,000 MΩ min.
	Between contacts of the same polarity	1,000 MΩ min.
Dielectric strength	Between coil and contacts	2,500 VAC, 1 min
	Between contacts of the same polarity	2,500 VAC, 1 min
Impulse withstand voltage (See note 4.)	4,500 V	
Vibration resistance	Destruction	10 to 55 to 10 Hz 0.75-mm single amplitude (Acceleration: 2.94 to 88.9 m/s ²)
	Malfunction	10 to 55 to 10 Hz 0.75-mm single amplitude (Acceleration: 2.94 to 88.9 m/s ²)
Shock resistance	Destruction	490 m/s ²
	Malfunction	196 m/s ²
Mechanical endurance (See note 5.)	200,000 operations min.	
Electrical endurance (resistive load) (See note 6.)	400 VDC, 200 A, 3,000 operations min.	
Short-time carry current	300 A (15 min)	
Maximum interruption current	1,000 A at 400 VDC (10 times)	
Overload interruption	700 A at 400 VDC (40 times min.)	
Reverse polarity interruption	-200 A at 200 VDC (1,000 times min.)	
Ambient operating temperature	-40 to 50°C (with no icing or condensation)	
Ambient operating humidity	5% to 85%	
Weight	Approx. 560 g	

- Note:**
1. The above values are initial values at an ambient temperature of 23°C unless otherwise specified.
 2. The contact resistance was measured with 1 A at 5 VDC using the voltage drop method.
 3. The insulation resistance was measured with a 500-VDC megohmmeter.
 4. The impulse withstand voltage was measured with a JEC-212 (1981) standard impulse voltage waveform (1.2 × 50 μs).
 5. The mechanical endurance was measured at a switching frequency of 3,600 operations/hr.
 6. The electrical endurance was measured at a switching frequency of 60 operations/hr.

Engineering Data

■ G9EC-1(-B) Switching/Current Conduction Models

Maximum Switching Capacity

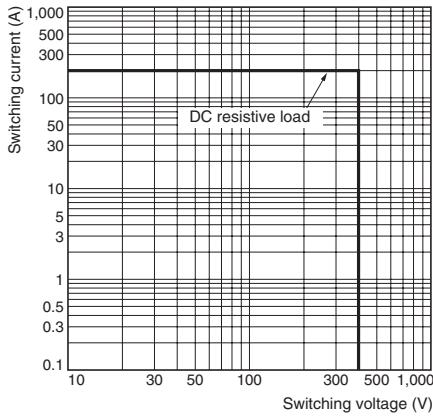

Electrical Endurance (Switching Performance)

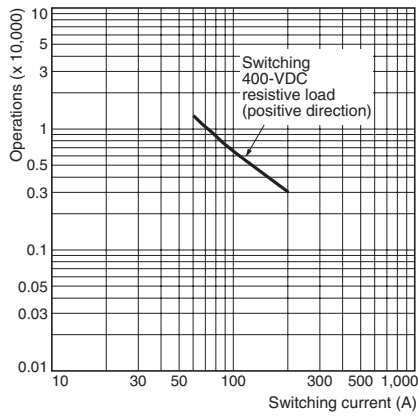

Electrical Endurance (Interruption Performance)

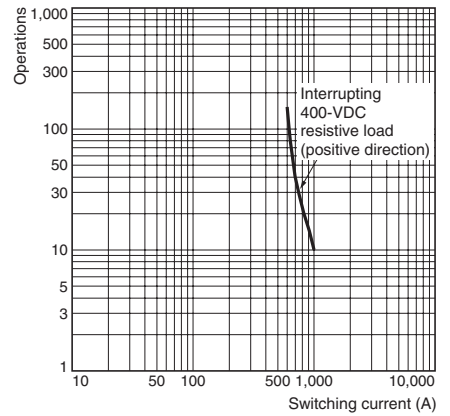

Carry Current vs Energizing Time

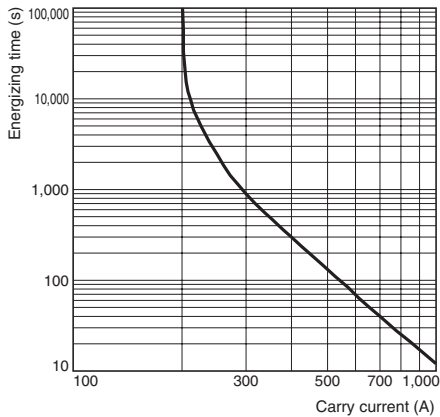

Must-operate Voltage and Must-release Voltage Distributions

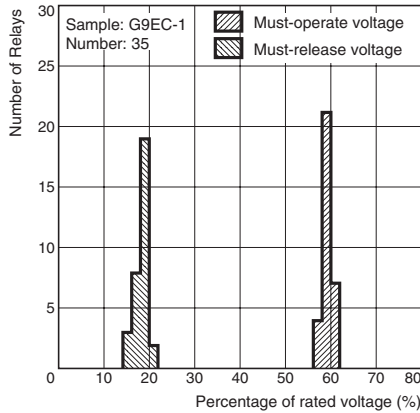

Time Characteristic Distributions

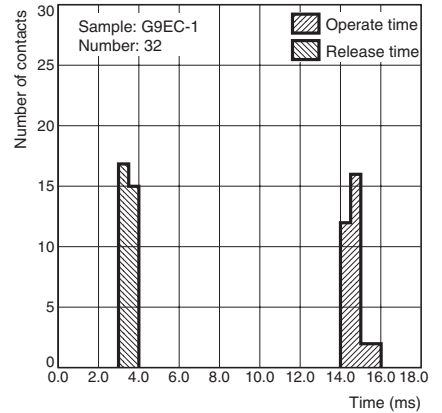

Vibration Malfunction

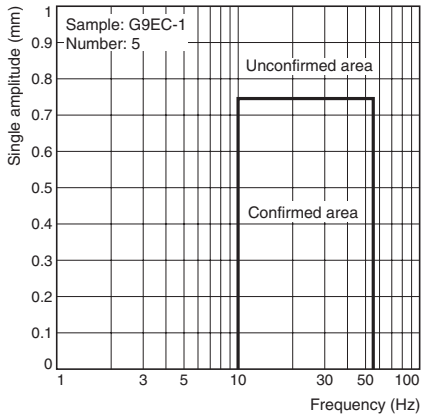

Vibration Resistance

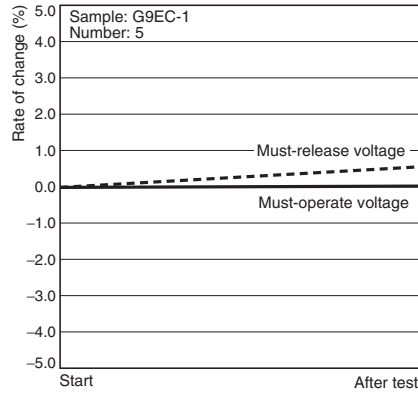

Characteristics were measured after applying vibration at a frequency of 10 to 55 Hz (single amplitude of 0.75 mm) to the test piece (not energized) for 2 hours each in 3 directions. The percentage rate of change is the average value for all of the samples

Shock Malfunction

Unit: m/s^2
Sample: G9EC-1
Number: 5

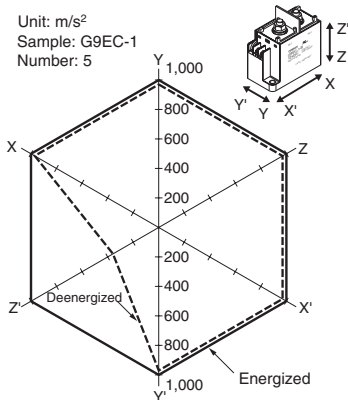

The value at which malfunction occurred was measured after applying shock to the test piece 3 times each in 6 directions along 3 axes.

Shock Resistance

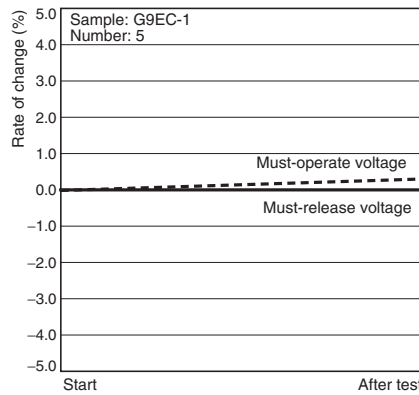

Characteristics were measured after applying a shock of $490 m/s^2$ to the test piece 3 times each in 6 directions along 3 axes. The percentage rate of change is the average value for all of the samples.

Dimensions

Note: All units are in millimeters unless otherwise indicated.

Models with Screw Terminals

G9EC-1-B

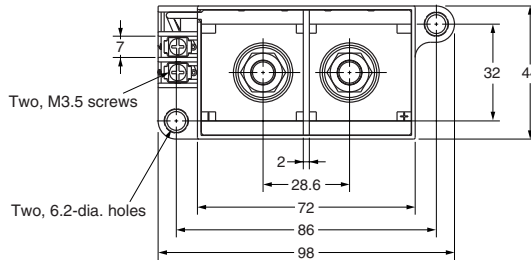
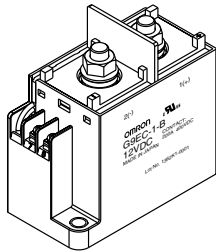

Terminal Arrangement/
Internal Connections
(TOP VIEW)

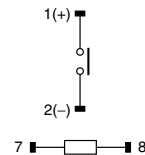

Note: Be sure to connect terminals with the correct polarity. Coils do not have polarity.

Mounting Hole Dimensions
(TOP VIEW)

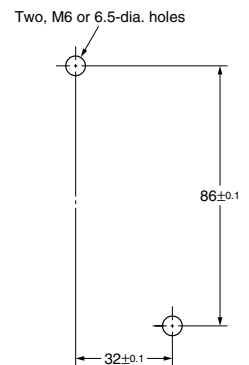

Dimension (mm)	Tolerance (mm)
10 or lower	±0.3
10 to 50	±0.5
50 or higher	±1

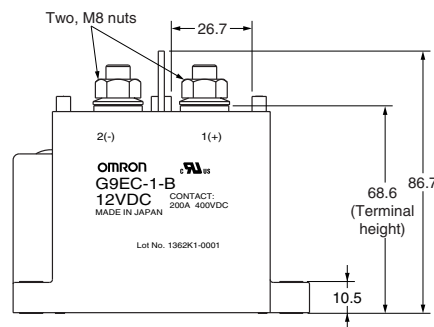
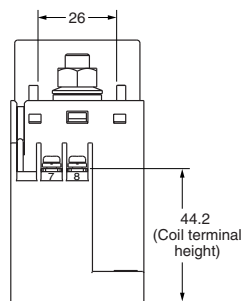

Models with Lead Wires

G9EC-1

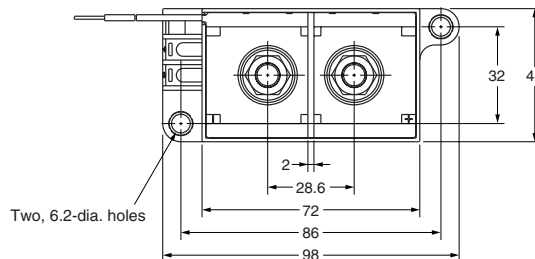
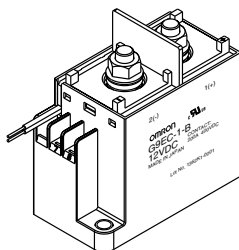

Terminal Arrangement/
Internal Connections
(TOP VIEW)

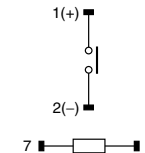

Note: Be sure to connect terminals with the correct polarity. Coils do not have polarity.

Mounting Hole Dimensions
(TOP VIEW)

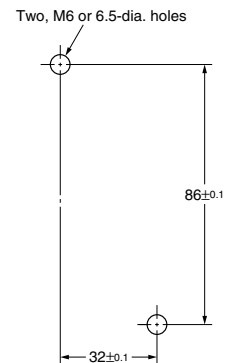

Dimension (mm)	Tolerance (mm)
10 or lower	±0.3
10 to 50	±0.5
50 or higher	±1

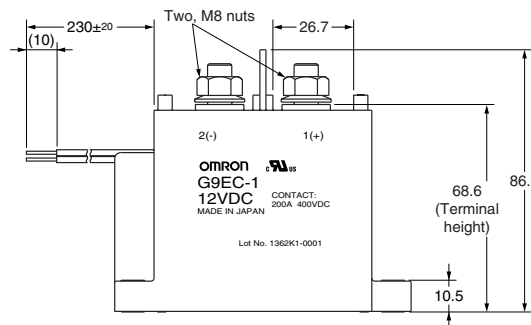
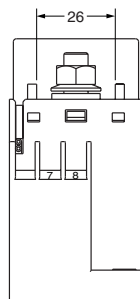

Options

Terminal Cover

P9EC-C

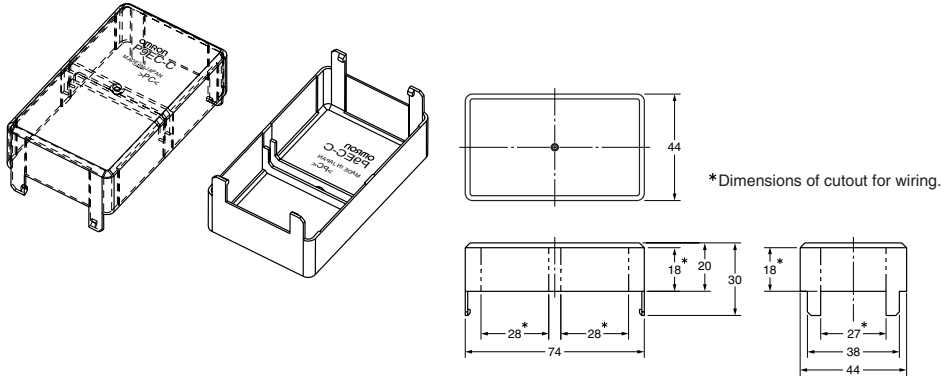

Note: Be sure to remove the cutouts for wiring that are located in the wiring outlet direction before installing the Terminal Cover.

Dimension (mm)	Tolerance (mm)
10 or lower	±0.3
10 to 50	±0.5
50 or higher	±1

DC Power Relays (25-A Models) G9EB-1

DC Power Relays Capable of Interrupting High-voltage, High-current DC Load

- Utilizes a unique gas-filled, fully sealed, non-ceramic construction achieved by using resin with a metal case. This reduces the need for special processing and materials that were required with previous models, resulting in a low-cost relay that is both compact and lightweight.
- Smallest and lightest in its class at 25 × 60 × 58 mm and approximately 135 g. This is approximately half the volume and a third of the weight of other DC Power Relays in the same class (400 VDC, 25 A).*
- The unique design of the contact switching component and permanent magnet for blowing out the arc eliminates the need for polarity in the main circuit (contact terminal). This improves ease of wiring and installation, and contributes to providing fail-safe measures against incorrect wiring.

* Based on our investigation as of December 2004.

Note: Refer to *Precautions* on page 22.



Model Number Structure

Model Number Legend

G9EB-□-□-□-□
1 2 3 4

- Number of Poles**
1: 1 pole
- Contact Form**
Blank: SPST-NO
- Coil Terminals**
B: M4 screw terminals
- Special Functions**

Ordering Information

List of Models

Models	Terminals		Contact form	Coil rated voltage	Model
	Coil terminals	Contact terminals			
Switching/current conduction models	Screw terminals (See note 2.)	Screw terminals (See note 1.)	SPST-NO	12 VDC 24 VDC 48 VDC 60 VDC 100 VDC	G9EB-1-B

- Note:** 1. Two M4 screws are provided for the contact terminal connection.
2. Two M4 screws are provided for the coil terminal connection.

Specifications

■ Ratings

Coil

Rated voltage	Rated current	Coil resistance	Must-operate voltage	Must-release voltage	Maximum voltage (See note 3.)	Power consumption
12 VDC	166.7 mA	72 Ω	75% max. of rated voltage	10% min. of rated voltage	130% of rated voltage (at 23°C within 10 minutes)	Approx. 2 W
24 VDC	83.3 mA	288 Ω				
48 VDC	41.7 mA	1,152 Ω				
60 VDC	33.3 mA	1,800 Ω				
100 VDC	20 mA	5,000 Ω				

- Note:**
- The figures for the rated current and coil resistance are for a coil temperature of 23°C and have a tolerance of ±10%.
 - The figures for the operating characteristics are for a coil temperature of 23°C.
 - The figure for the maximum voltage is the maximum voltage that can be applied to the relay coil.

Contacts

Item	Resistive load
	G9EB-1(-B)
Rated load	25 A at 250 VDC
Rated carry current	25 A
Maximum switching voltage	250 V
Maximum switching current	25 A

■ Characteristics

Item	G9EB-1-B	
Contact resistance (See note 2.)	30 mΩ max.	
Contact voltage drop	0.1 V max. (for a carry current of 25 A)	
Operate time	30 ms max.	
Release time	15 ms max.	
Insulation resistance (See note 3.)	Between coil and contacts	1,000 MΩ min.
	Between contacts of the same polarity	1,000 MΩ min.
Dielectric strength	Between coil and contacts	2,500 VAC, 1 min
	Between contacts of the same polarity	2,500 VAC, 1 min
Impulse withstand voltage (See note 4.)	4,500 V	
Vibration resistance	Destruction	10 to 55 to 10 Hz, 0.75-mm single amplitude (Acceleration: 2.94 to 88.9 m/s ²)
	Malfunction	10 to 55 to 10 Hz, 0.75-mm single amplitude (Acceleration: 2.94 to 88.9 m/s ²)
Shock resistance	Destruction	490 m/s ²
	Malfunction	100 m/s ²
Mechanical endurance (See note 5.)	100,000 operations min.	
Electrical endurance (resistive load) (See note 6 and 7.)	250 VDC, 25 A, 30,000 ops. min.	
Short-time carry current	50 A (5 min), 40 A (10 min)	
Maximum interruption current (See note 7.)	100 A at 250 VDC (5 times)	
Overload interruption (See note 7.)	50 A at 250 VDC (50 times min.)	
Ambient operating temperature	-40 to 70°C (with no icing or condensation)	
Ambient operating humidity	5% to 85%	
Weight (including accessories)	Approx. 135 g	

- Note:**
- The above values are initial values at an ambient temperature of 23°C unless otherwise specified.
 - The contact resistance was measured with 1 A at 5 VDC using the voltage drop method.
 - The insulation resistance was measured with a 500-VDC megohmmeter.
 - The impulse withstand voltage was measured with a JEC-212 (1981) standard impulse voltage waveform (1.2 × 50 μs).
 - The mechanical endurance was measured at a switching frequency of 3,600 operations/hr.
 - The electrical endurance was measured at a switching frequency of 60 operations/hr.
 - These values are for when a varistor is used as the protective circuit against reverse surge in the relay coil. Using a diode will reduce the switching characteristics.

Engineering Data

■ G9EB-1-B Switching/Current Conduction Models

Maximum Switching Capacity

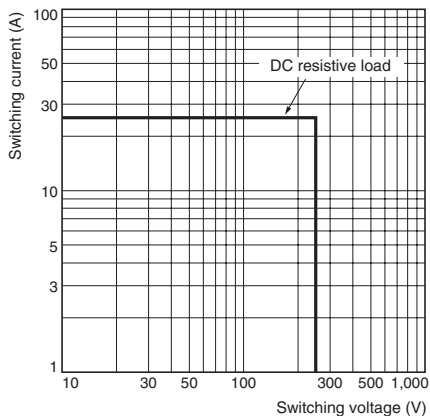

Electrical Endurance (Switching Performance)

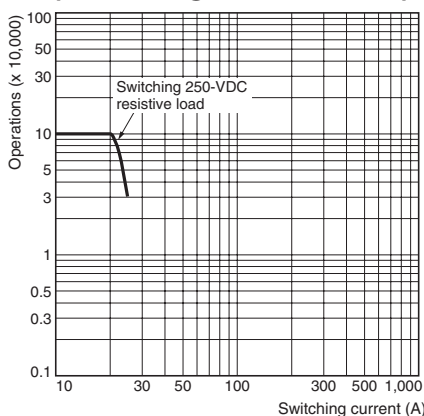

Electrical Endurance (Interruption Performance)

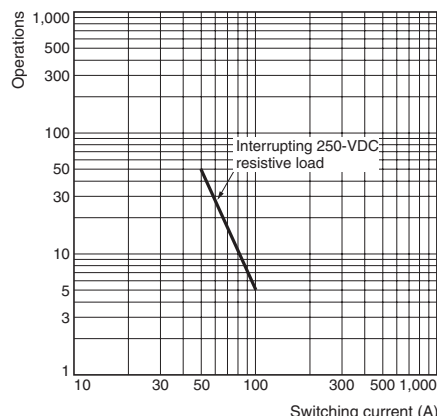

Carry Current vs Energizing Time

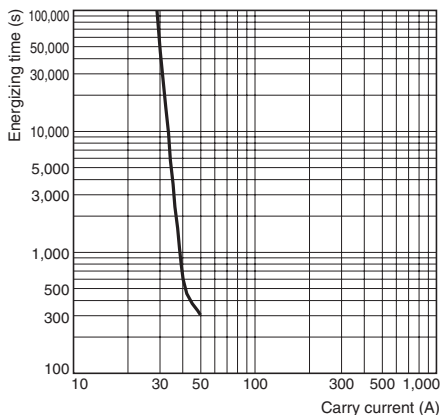

Must-operate Voltage and Must-release Voltage Distributions

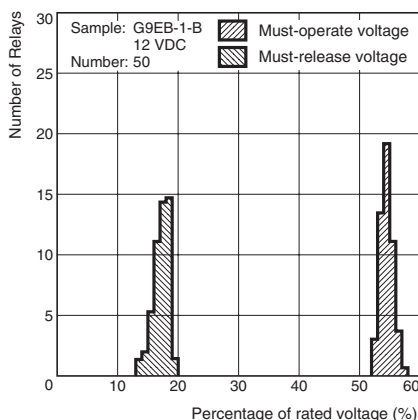

Time Characteristic Distributions

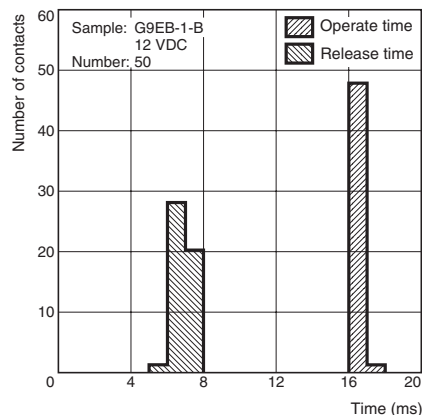

Vibration Malfunction

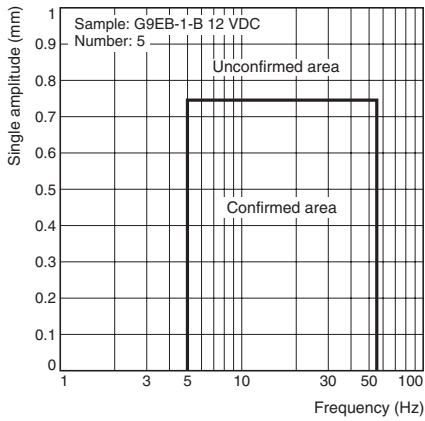

Vibration Resistance

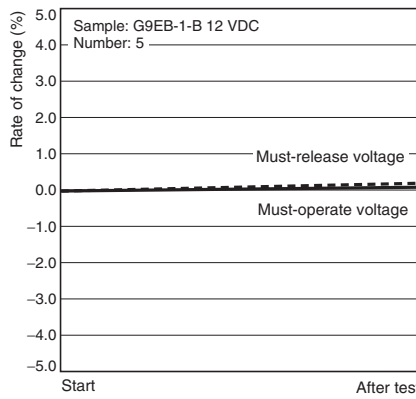

Characteristics were measured after applying vibration at a frequency of 10 to 55 Hz (single amplitude of 0.75 mm) to the test piece (not energized) for 2 hours each in 3 directions. The percentage rate of change is the average value for all of the samples

Shock Malfunction

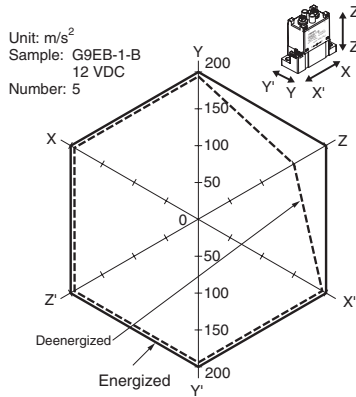

The value at which malfunction occurred was measured after applying shock to the test piece 3 times each in 6 directions along 3 axes.

Shock Resistance

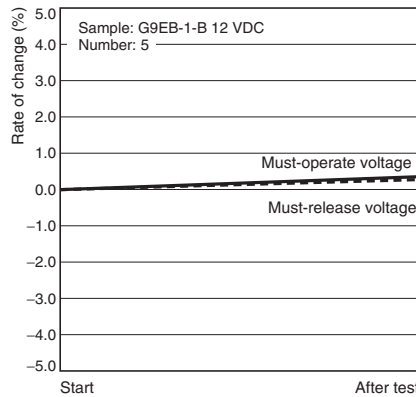

Characteristics were measured after applying a shock of $490 m^2/s$ to the test piece 3 times each in 6 directions along 3 axes. The percentage rate of change is the average value for all of the samples.

Dimensions

Note: All units are in millimeters unless otherwise indicated.

Screw Terminal Type

G9EB-1-B

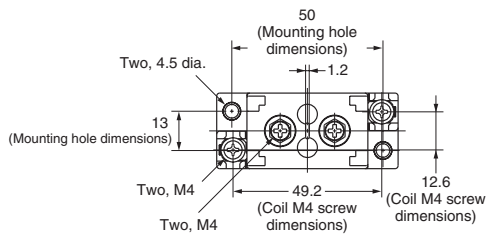
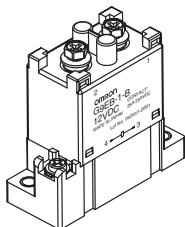

Terminal Arrangement/
Internal Connections
(TOP VIEW)

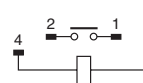

Mounting Hole Dimensions
(TOP VIEW)

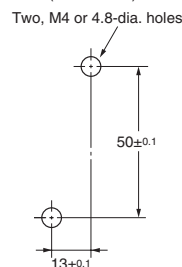

Dimension (mm)	Tolerance (mm)
10 or lower	±0.3
10 to 50	±0.5
50 or higher	±1

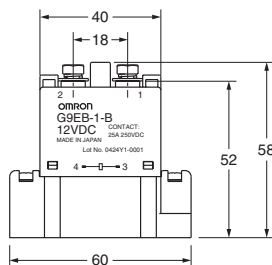
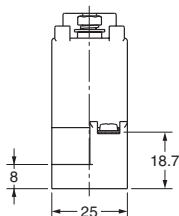

Precautions

⚠ WARNING

Take measures to prevent contact with charged parts when using the Relay for high voltages.



■ Precautions for Correct Use

Refer to the relevant catalog for common precautions.

- Be sure to tighten all screws to the appropriate torque given below. Loose screws may result in burning due to abnormal heat generation during energization.
 - M8 screws: 8.82 to 9.80 N·m
 - M6 screws: 3.92 to 4.90 N·m
 - M5 screws: 1.57 to 2.35 N·m
 - M4 screws: 0.98 to 1.37 N·m
 - M3.5 screws: 0.75 to 1.18 N·m
- The G9EA and G9EC Relays' contacts have polarity. Be sure to perform connections with the correct polarity. If the contacts are connected with the reverse polarity, the switching characteristics specified in this document cannot be assured.
- Do not drop or disassemble this Relay. Not only may the Relay fail to meet the performance specifications, it may also result in damage, electric shock, or burning.
- Do not use these Relays in strong magnetic fields of 800 A/m or higher (e.g., near transformers or magnets). The arc discharge that occurs during switching may be bent by the magnetic field, resulting in flashover or insulation faults.
- This Relay is a device for switching high DC voltages. If it is used for voltages exceeding the specified range, it may not be possible to interrupt the load and burning may result. In order to prevent fire spreading, use a configuration in which the current load can be interrupted in the event of emergencies.
In order to ensure safety of the system, replace the Relay on a regular basis.
- If the Relay is used for no-load switching, the contact resistance may increase and so confirm correct operation under the actual operating conditions.
- These Relays contain pressurized gas. Even in applications with low switching frequencies, the ambient temperature and heat caused by arc discharge in the contacts may allow permeation of the sealed gas, resulting in arc interruption failure.
In order to ensure safety of the system, replace Relays on a regular basis.
- Do not use or store the Relay in a vacuum. Doing so will accelerate deterioration of the sealing.
- With this Relay, if the rated voltage (or current) is continuously applied to the coil and contacts, and then turned OFF and immediately ON again, the coil temperature, and consequently the coil resistance, will be higher than usual. This means that the must operate voltage will also be higher than usual, exceeding the rated value ("hot start"). In this case, take the appropriate countermeasures, such as reducing the load current or restricting the energizing time or ambient operating temperature.
- The ripple percentage for DC relays can cause fluctuations in the must-operate voltage or humming. For this reason, reduce the ripple percentage in full-wave rectified power supply circuits by adding a smoothing capacitor. Ensure that the ripple percentage is less than 5%.
- Ensure that a voltage exceeding the specified maximum voltage is not continuously applied to the coil. Abnormal heating in the coil may shorten the lifetime of the insulation coating.
- Do not use the Relay at a switching voltage or current greater than the specified maximum values. Doing so may result in arc discharge interruption failure or burning due to abnormal heating in the contacts.
- The contact ratings are for resistive loads. The electrical endurance with inductive loads is inferior to that of resistive loads. Confirm correct operation under the actual operating conditions.
- Do not use the Relay in locations where water, solvents, chemicals, or oil may come in contact with the case or terminals. Doing so may result in deterioration of the case resin or abnormal heating due to corrosion or contamination of the terminals. Also, if electrolyte adheres to the output terminals, electrolysis may occur between the output terminals, resulting in corrosion of the terminals or wiring disconnections.
- Be sure to turn OFF the power and confirm that there is no residual voltage before replacing the Relay or performing wiring.
- The distance between crimp terminals or other conductive parts will be reduced and insulation properties will be lowered if wires are laid in the same direction from the contact terminals. Use insulating coverings, do not wire in the same direction, and take other measures as required to maintain insulation properties.
- Use either a varistor, or a diode plus Zener diode as a protective circuit against reverse surge in the relay coil. Using a diode alone will reduce the switching characteristics.
- Be sure to use the screws provided with the product for wiring coil terminals and contact terminals. The specified tightening torque cannot be achieved with different screws and may result in abnormal heat generation when energized.

Recommended Wire Size

Model	Size
G9EA-1(-B)	14 to 22 mm ²
G9EA-1(-B)-CA	22 to 38 mm ²
G9EC-1(-B)	38 to 60 mm ²
G9EB-1-B	2 to 5.5 mm ²

Note: Use flexible leads.

ALL DIMENSIONS SHOWN ARE IN MILLIMETERS.

To convert millimeters into inches, multiply by 0.03937. To convert grams into ounces, multiply by 0.03527.

Cat. No. J144-E1-04 **In the interest of product improvement, specifications are subject to change without notice.**

OMRON RELAY & DEVICES Corporation

DC Power Business Promotion Department

1110, Sugi, Yamaga-city, Kumamoto-Pref., 861-0596 Japan

Tel: (81)968-44-4641/Fax: (81)968-44-4107

Printed in Japan
1106-0.2M (1003) (C)