



FEATURES

1. Compact with high contact rating

Even with small 10 mm .394 inch (H) x 11 mm .433 inch (W) x 20 mm .787 inch (L) (dimensions, high capacity switching is provided: 1a, 8 A 250 V AC; 2a and 1a1b, 5 A 250 V AC.

2. High switching capability

High contact pressure, low contact bounce, and wiping operation improve resistance to weld bonding. Resistant against lamp load and dielectric loading: 1a achieves maximum switching capacity of 2,000 VA (8A 250 V AC).

3. High sensitivity

Using the same type of high-performance polar magnetic circuits as DS relays, by matching the spring load to the magnetic force of attraction, greater sensitivity has been achieved. The resultant pick up sensitivity of about 190 mW makes possible direct driving of transistors and chips.

4. High breakdown voltage

Breakdown voltage has been raised by keeping the coil and contacts separate.

Between contact and coil	Between contacts
3,000 Vrms for 1 min. 5,000 V surge breakdown voltage	1,000 Vrms for 1 min. 1,500 V surge breakdown voltage

Conforms with FCC Part 68

5. Latching types available

6. Wide variation

Three types of contact arrangement are offered: 1a, 2a, and 1a1b. In addition, each is available in standard and reversed polarity types.

7. Sealed construction allows automatic washing

8. Complies with safety standards

- Complies with Japan Electrical Appliance and Material Safety Law requirements for operating 200 V power supply circuits
- Complies with UL, CSA and TÜV safety standards
- Complies with EN 60335 / GWT (test report available)

9. Creepage distance and clearances between contact and coil: 3.5 mm

10. Sockets are available.

TYPICAL APPLICATIONS

1. Office and industrial electronic devices
2. Terminal devices of information processing equipment, such as printer, data recorder.
3. Office equipment (copier, facsimile)
4. Measuring instruments
5. NC machines, temperature controllers and programmable logic controllers.

ORDERING INFORMATION

DSP - - - -

Contact arrangement

- 1a: 1 Form A
- 1: 1 Form A 1 Form B
- 2a: 2 Form A

Operating function

- Nil: Single side stable
- L: 1 coil latching
- L2: 2 coil latching

Coil voltage

- DC 3, 5, 6, 9, 12, 24 V

Polarity

- Nil: Standard polarity
- R: Reverse polarity

Contact material

- AgSnO₂ type
- F: 1 Form A 1 Form B
- Nil: 1 Form A, 2 Form A

Notes: 1. Reverse polarity types available (add suffix-R)
2. UL/CSA, TÜV approved type is standard.

DSP

TYPES

Contact arrangement	Nominal coil voltage	Single side stable	1 coil latching	2 coil latching
		Part No.	Part No.	Part No.
1 Form A	3V DC	DSP1a-DC3V	DSP1a-L-DC3V	DSP1a-L2-DC3V
	5V DC	DSP1a-DC5V	DSP1a-L-DC5V	DSP1a-L2-DC5V
	6V DC	DSP1a-DC6V	DSP1a-L-DC6V	DSP1a-L2-DC6V
	9V DC	DSP1a-DC9V	DSP1a-L-DC9V	DSP1a-L2-DC9V
	12V DC	DSP1a-DC12V	DSP1a-L-DC12V	DSP1a-L2-DC12V
	24V DC	DSP1a-DC24V	DSP1a-L-DC24V	DSP1a-L2-DC24V
1 Form A 1 Form B	3V DC	DSP1-DC3V-F	DSP1-L-DC3V-F	DSP1-L2-DC3V-F
	5V DC	DSP1-DC5V-F	DSP1-L-DC5V-F	DSP1-L2-DC5V-F
	6V DC	DSP1-DC6V-F	DSP1-L-DC6V-F	DSP1-L2-DC6V-F
	9V DC	DSP1-DC9V-F	DSP1-L-DC9V-F	DSP1-L2-DC9V-F
	12V DC	DSP1-DC12V-F	DSP1-L-DC12V-F	DSP1-L2-DC12V-F
	24V DC	DSP1-DC24V-F	DSP1-L-DC24V-F	DSP1-L2-DC24V-F
2 Form A	3V DC	DSP2a-DC3V	DSP2a-L-DC3V	DSP2a-L2-DC3V
	5V DC	DSP2a-DC5V	DSP2a-L-DC5V	DSP2a-L2-DC5V
	6V DC	DSP2a-DC6V	DSP2a-L-DC6V	DSP2a-L2-DC6V
	9V DC	DSP2a-DC9V	DSP2a-L-DC9V	DSP2a-L2-DC9V
	12V DC	DSP2a-DC12V	DSP2a-L-DC12V	DSP2a-L2-DC12V
	24V DC	DSP2a-DC24V	DSP2a-L-DC24V	DSP2a-L2-DC24V

Standard packing: Carton: 50 pcs.; Case: 500 pcs.

Note: Reverse polarity type are manufactured by lot upon receipt of order. Self-clinching types are also available, please consult us.

RATING

1. Coil data

1) Single side stable

Nominal coil voltage	Pick-up voltage (at 20°C 68°F)	Drop-out voltage (at 20°C 68°F)	Nominal operating current [±10%] (at 20°C 68°F)	Coil resistance [±10%] (at 20°C 68°F)	Nominal operating power	Max. allowable voltage (at 20°C 68°F)
3V DC	80%V or less of nominal voltage (Initial)	10%V or more of nominal voltage (Initial)	100mA	30Ω	300mW	130%V of nominal voltage
5V DC			60mA	83Ω		
6V DC			50mA	120Ω		
9V DC			33.3mA	270Ω		
12V DC			25mA	480Ω		
24V DC			12.5mA	1,920Ω		

2) 1 coil latching

Nominal coil voltage	Pick-up voltage (at 20°C 68°F)	Reset voltage (at 20°C 68°F)	Nominal operating current [±10%] (at 20°C 68°F)		Coil resistance [±10%] (at 20°C 68°F)		Nominal operating power		Max. allowable voltage (at 20°C 68°F)
			Set coil	Reset coil	Set coil	Reset coil	Set coil	Reset coil	
3V DC	80%V or less of nominal voltage (Initial)	80%V or less of nominal voltage (Initial)	50mA	50mA	60Ω	60Ω	150mW	150mW	130%V of nominal voltage
5V DC			30mA	30mA	167Ω	167Ω			
6V DC			25mA	25mA	240Ω	240Ω			
9V DC			16.7mA	16.7mA	540Ω	540Ω			
12V DC			12.5mA	12.5mA	960Ω	960Ω			
24V DC			6.3mA	6.3mA	3,840Ω	3,840Ω			

3) 2 coil latching

Nominal coil voltage	Set voltage (at 20°C 68°F)	Reset voltage (at 20°C 68°F)	Nominal operating current [±10%] (at 20°C 68°F)		Coil resistance [±10%] (at 20°C 68°F)		Nominal operating power		Max. allowable voltage (at 20°C 68°F)
			Set coil	Reset coil	Set coil	Reset coil	Set coil	Reset coil	
3V DC	80%V or less of nominal voltage (Initial)	80%V or less of nominal voltage (Initial)	100mA	100mA	30Ω	30Ω	300mW	300mW	130%V of nominal voltage
5V DC			60mA	60mA	83Ω	83Ω			
6V DC			50mA	50mA	120Ω	120Ω			
9V DC			33.3mA	33.3mA	270Ω	270Ω			
12V DC			25mA	25mA	480Ω	480Ω			
24V DC			12.5mA	12.5mA	1,920Ω	1,920Ω			

2. Specifications

Characteristics	Item	Specifications		
		1 Form A	1 Form A 1 Form B	2 Form A
Contact	Arrangement			
	Initial contact resistance, max.	Max. 30 mΩ (By voltage drop 6 V DC 1A)		
	Contact material	Au-flashed AgSnO ₂ type		
Rating	Nominal switching capacity (resistive load)	8 A 250 V AC, 5A 30V DC	5 A 250 V AC, 5 A 30 V DC	
	Max. switching power (resistive load)	2,000 VA, 150 W	1,250 VA, 150 W	
	Max. switching voltage	250 V AC, 125 V DC		
	Max. switching current	8 A AC, 5 A DC	5 A AC, DC	
	Nominal operating power	Single side stable, 2 coil latching: 300 mW. 1 coil latching: 150mW		
	Min. switching capacity (Reference value)*1	10m A 5 V DC		
Electrical characteristics	Insulation resistance (Initial)	Min. 1,000MΩ (at 500V DC) Measurement at same location as "Initial breakdown voltage" section.		
	Breakdown voltage (Initial)	Between open contacts	1,000 Vrms for 1 min. (Detection current: 10mA.)	
		Between contact sets	2,000 Vrms (1 Form A 1 Form B, 2 Form A) (Detection current: 10mA.)	
		Between contact and coil	3,000 Vrms for 1 min. (Detection current: 10mA.)	
	Surge breakdown voltage*2	between contacts and coil 5,000 V		
	Temperature rise (at 65°C 149°F)	Max. 55°C	Max. 40°C	Max. 55°C
	Operate time [Set time] (at 20°C 68°F)	Max. 10 ms [10 ms] (Nominal voltage applied to the coil, excluding contact bounce time.)		
Release time [Reset time] (at 20°C 68°F)	Max. 5 ms [10 ms] (Nominal voltage applied to the coil, excluding contact bounce time.) (without diode)			
Mechanical characteristics	Shock resistance	Functional	Min. 196 m/s ² (Half-wave pulse of sine wave: 11 ms; detection time: 10μs.)	
		Destructive	Min. 980 m/s ² (Half-wave pulse of sine wave: 6 ms.)	
	Vibration resistance	Functional	10 to 55 Hz at double amplitude of 2 mm (Detection time: 10μs.)	
		Destructive	10 to 55 Hz at double amplitude of 3.5 mm	
Expected life	Mechanical	Min. 5×10 ⁷ (at 180 times/min.)		
	Electrical	Min. 10 ⁵ (resistive load)		
Conditions	Conditions for operation, transport and storage*3 (Not freezing and condensing at low temperature)	Ambient temperature: -40°C to +60°C -40°F to +140°F	Ambient temperature: -40°C to +65°C -40°F to +149°F	Ambient temperature: -40°C to +60°C -40°F to +140°F
	Solder heating	250°C 482°F (10s), 300°C 572°F (5s), 350°C 662°F (3s) (Soldering depth: 2/3 terminal pitch)		
	Max. operating speed	3 cps		
Unit weight	Approx. 4.5 g .16 oz			

Notes:

*1 This value can change due to the switching frequency, environmental conditions, and desired reliability level, therefore it is recommended to check this with the actual load.

*2 Wave is standard shock voltage of ±1.2×50μs according to JEC-212-1981

*3 Refer to "6. Usage, Storage and Transport Conditions" in AMBIENT ENVIRONMENT section in Relay Technical Information.

REFERENCE DATA

1. Max. switching capacity

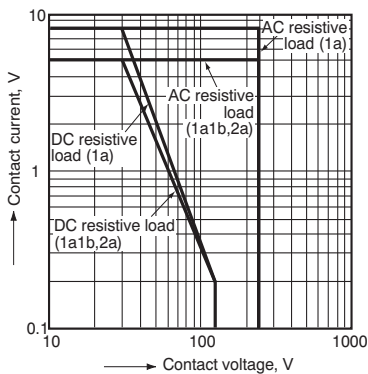

2.-(1) Life curve (1 Form A 1 Form B)

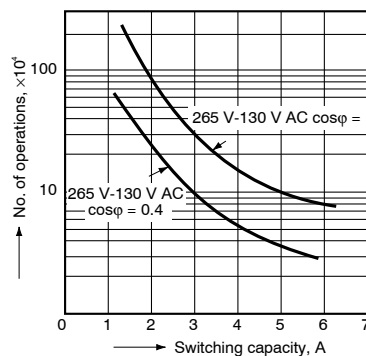

2.-(2) Life curve (1 Form A 1 Form B)

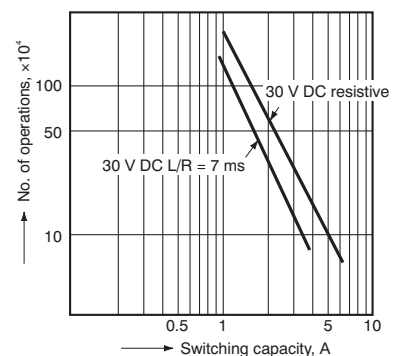

3.-(1) Coil temperature rise (1 Form A)
Tested sample: DSP1a-DC12V, 5 pcs.

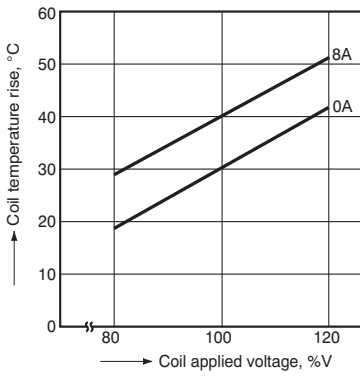

3.-(2) Coil temperature rise (1 Form A 1 Form B)
Tested sample: DSP1-DC12V, 5 pcs.

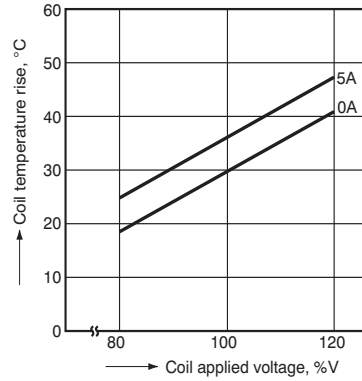

3.-(3) Coil temperature rise (2 Form A)
Tested sample: DSP2a-DC12V, 5 pcs.

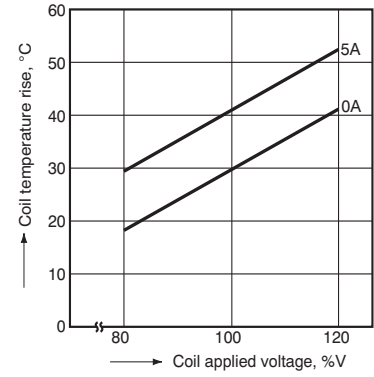

4.-(1) Operate & release time (without diode, 1 Form A)
Tested sample: DSP1a-DC12V, 5 pcs.

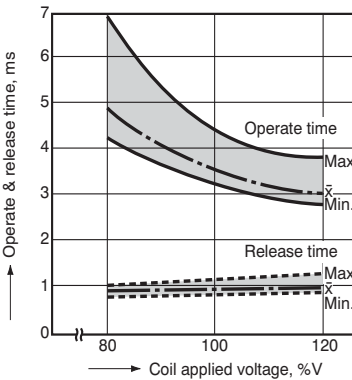

4.-(2) Operate & release time (without diode, 1 Form A 1 Form B)
Tested sample: DSP1-DC12V, 5 pcs.

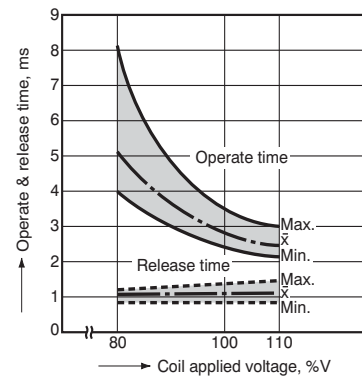

4.-(3) Operate & release time (without diode, 2 Form A)
Tested sample: DSP2a-DC12V, 5 pcs.

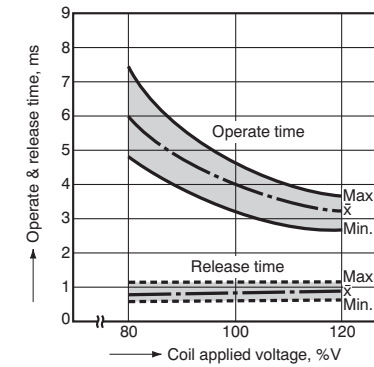

4.-(4) Operate & release time (with diode, 1 Form A)
Tested sample: DSP1a-DC12V, 5 pcs.

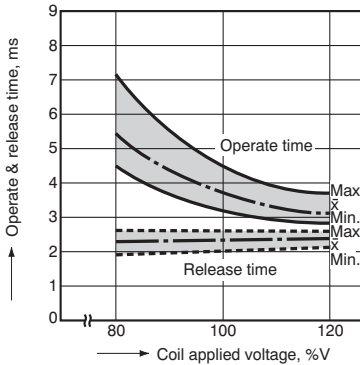

4.-(5) Operate & release time (with diode, 1 Form A 1 Form B)
Tested sample: DSP1-DC12V, 5 pcs.

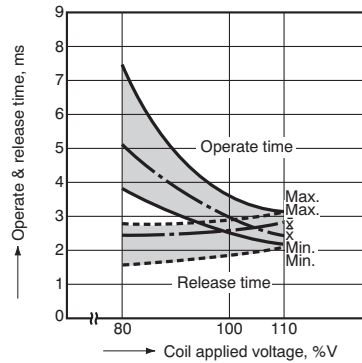

4.-(6) Operate & release time (with diode, 2 Form A)
Tested sample: DSP2a-DC12V, 5 pcs.

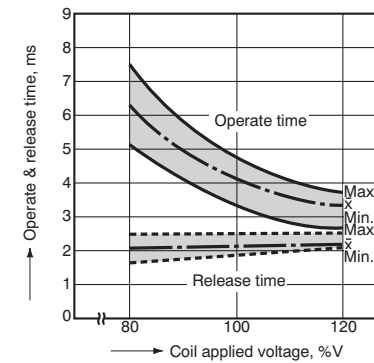

5.-(1) Change of pick-up and drop-out voltage (1 Form A)
Tested sample: DSP1a-DC12V, 5 pcs.

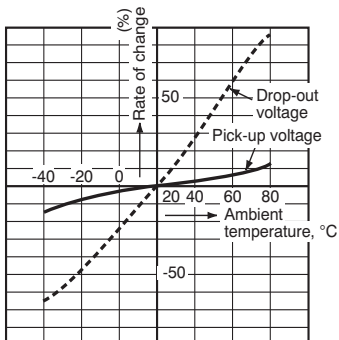

5.-(2) Change of pick-up and drop-out voltage (1 Form A 1 Form B)
Tested sample: DSP1-DC12V, 5 pcs.

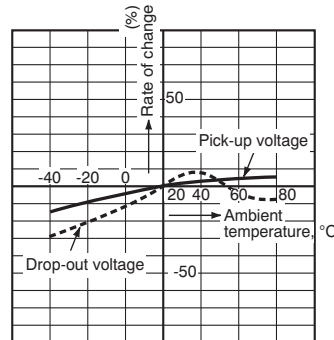

5.-(3) Change of pick-up and drop-out voltage (2 Form A)
Tested sample: DSP2a-DC12V, 5 pcs.

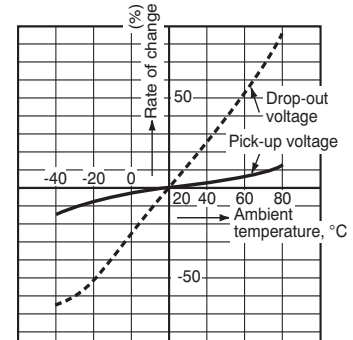

6.-(1) Influence of adjacent mounting
(1 Form A)

Tested sample: DSP1a-DC12V, 5 pcs.

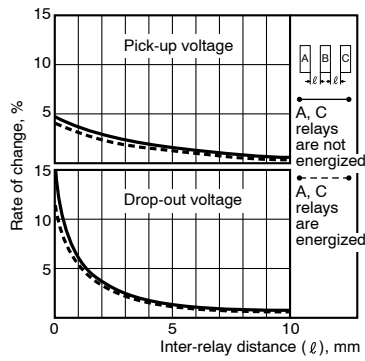

6.-(2) Influence of adjacent mounting
(1 Form A 1 Form B)

Tested sample: DSP1-DC12V, 5 pcs.

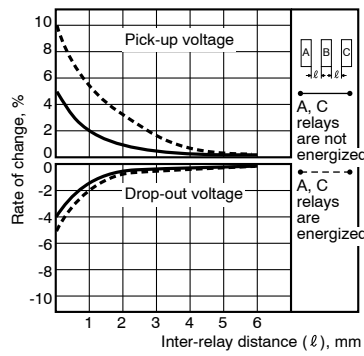

6.-(3) Influence of adjacent mounting
(2 Form A)

Tested sample: DSP2a-DC12V, 5 pcs.

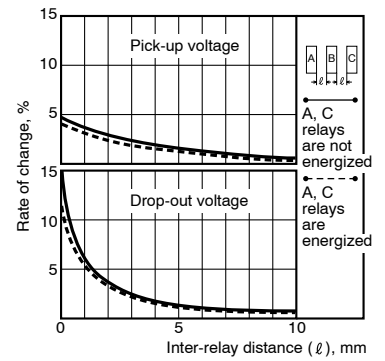

DIMENSIONS(mm inch)

Download [CAD Data](#) from our Web site.

1. 1 Form A type

[CAD Data](#)

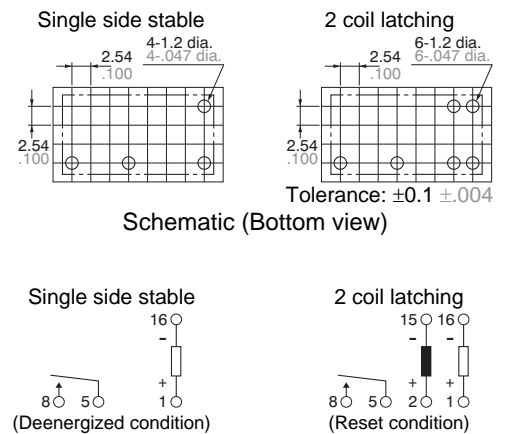
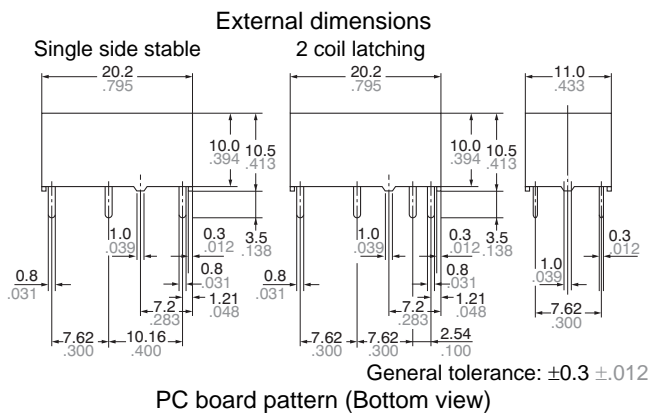

2. 1 Form A 1 Form B type

[CAD Data](#)

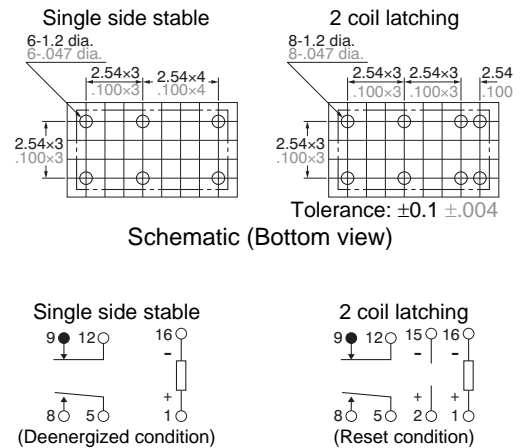
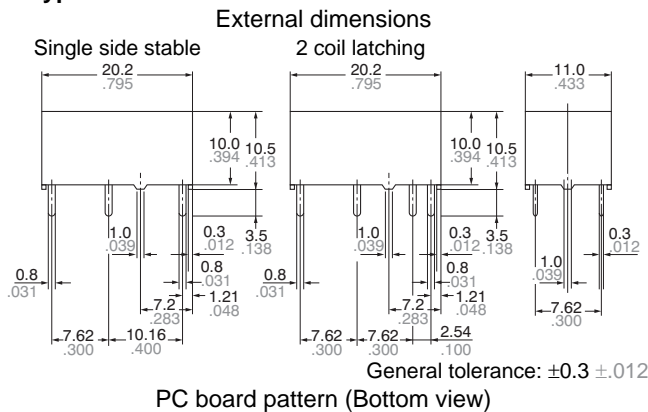
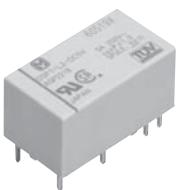

3. 2 Form A type

CAD Data

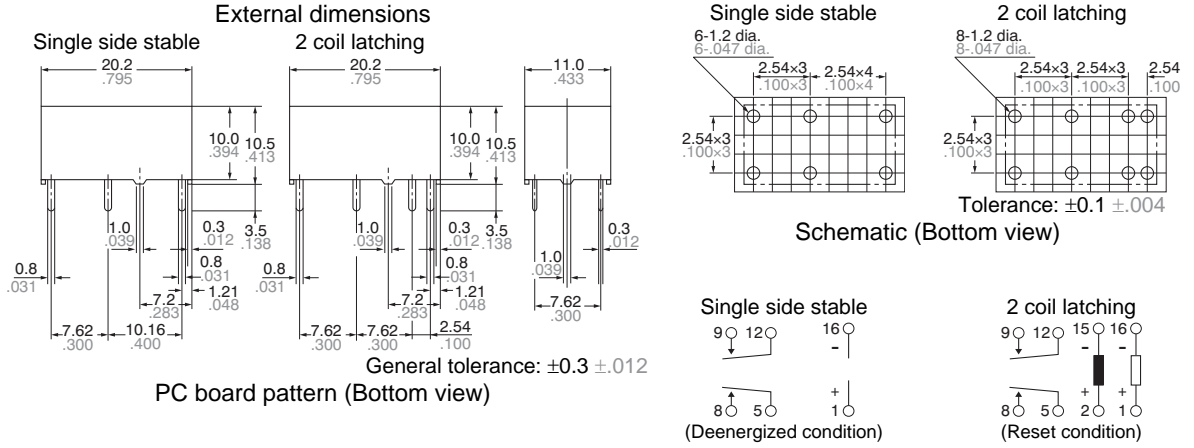
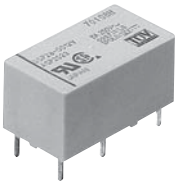

SAFETY STANDARDS

Item	UL/C-UL (Recognized)		CSA (Certified)		TÜV (Certified)	
	File No.	Contact rating	File No.	Contact rating	File No.	Rating
1 Form A	E43028	8A 250V AC 1/8HP 125, 250V AC 5A 30V DC	LR26550 etc.	8A 250V AC 1/8HP 125, 250V AC 5A 30V DC	B 02 10 13461 238	8A 250V AC (cosφ=1.0) 5A 250V AC (cosφ=0.4) 5A 30V DC
1 Form A 1 Form B	E43028	5A 250V AC 1/8HP 125, 250V AC 5A 30V DC	LR26550 etc.	5A 250V AC 1/8HP 125, 250V AC 5A 30V DC	B 02 10 13461 238	5A 250V AC (cosφ=1.0) 3A 250V AC (cosφ=0.4) 5A 30V DC
2 Form A	E43028	5A 250V AC 1/10HP 125, 250V AC 5A 30V DC	LR26550 etc.	5A 250V AC 1/10HP 125, 250V AC 5A 30V DC	B 02 10 13461 238	5A 250V AC (cosφ=1.0) 3A 250V AC (cosφ=0.4) 5A 30V DC

* Remarks: The standard certified for may differ depending on where the product was manufactured.

NOTES

1. Soldering should be done under the following conditions:

- 250°C 482°F within 10 s
- 300°C 572°F within 5 s
- 350°C 662°F within 3 s

2. Cleaning

For automatic cleaning, the boiling method is recommended. Avoid ultrasonic cleaning which subjects the relays to high frequency vibrations, which may cause the contacts to stick.

It is recommended that a fluorinated hydrocarbon or other alcoholic solvents be used.

3. External magnetic field

Since DY relays are highly sensitive polarized relays, their characteristics will be affected by a strong external magnetic field. Avoid using the relay under that condition.

4. Coil operating power

Pure DC current should be applied to the coil. The wave form should be rectangular. If it includes ripple, the ripple factor should be less than 5%.

However, check it with the actual circuit since the characteristics may be slightly different.

5. When using, please be aware that the a contact and b contact sides of 1 Form A and 1 Form B types may go on simultaneously at operate time and release time.

For Cautions for Use, see [Relay Technical Information](#).

ACCESSORIES

**SOCKETS FOR
DS-P RELAYS**

TYPES AND APPLICABLE RELAYS

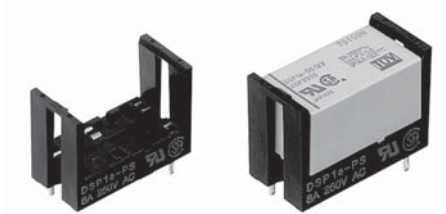

Type No.	For DSP1a		For DSP1a, DSP1, DSP2a	
	DSP1a-PS	DSP1a-PSL2	DSP2a-PS	DSP2a-PSL2
Applicable relays				
DSP1a relays	OK	OK	OK	OK
DSP1a-L2 relays		OK		OK
DSP1 relays			OK	OK
DSP1-L2 relays				OK
DSP2a relays			OK	OK
DSP2a-L2 relays				OK

SPECIFICATIONS

Item	Specifications
Breakdown voltage	3,000 Vrms between terminals (Except for the portion between coil terminals)
Insulation resistance	1,000 MΩ between terminals at 500 V
Heat resistance	150°C for 1 hour
Max. continuous current	8 A

DIMENSIONS (Unit: mm inch)

External dimensions

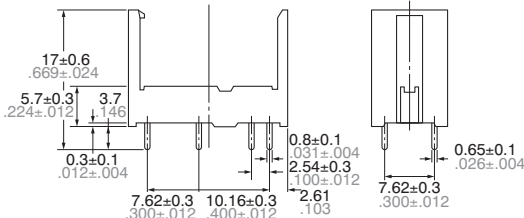
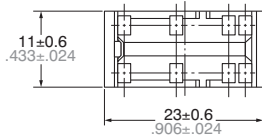

PC board pattern (Bottom view)

DSP1a-PS, DSP1a-PSL2

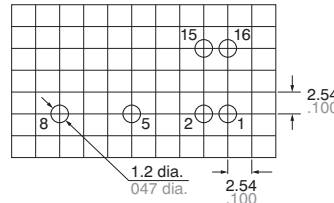

Terminal No.2 and 15 are for DSP1a-PSL2 only.

DSP2a-PS, DSP2a-PSL2

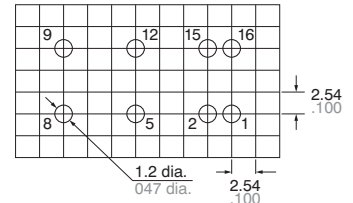

Terminal No.2 and 15 are for DSP2a-PSL2 only.

FIXING AND REMOVAL METHOD

1. Match the direction of relay and socket.

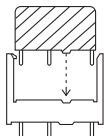

2. Both ends of relays are fixed so tightly that the socket hooks on the top surface of relays.

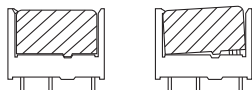

Good

No good

3. Remove the relay, applying force in the direction shown below.

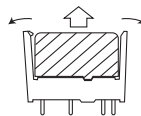

4. In case there is not enough space for finger to pick relay up, use screw drivers in the way shown below.

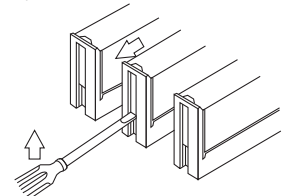

Notes: 1. Exercise care when removing relays. If greater than necessary force is applied at the socket hooks, deformation may alter the dimensions so that the hook will no longer catch, and other damage may also occur.
2. It is hazardous to use IC chip sockets.