

## Overview

Ferrite power inductors are useful in various fields and suitable for DC/DC converters and noise filters.

## Applications

Typical applications include LED lighting, xDSL modems, copying machines, flat TVs, smart meters, and power supplies.

## Benefits

- Drum core construction
- Nickel-zinc (NiZn) ferrite core
- Magnetic non-shield type
- Operating temperature range of up to +105°C
- Available in Tape and Reel
- RoHS compliant

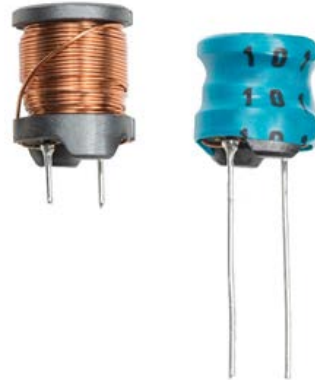

## Ordering Information

SBCP-	47HY	150	H	B
Series	Core Size	Inductance Code (μH)	External Tube	Packaging Type
SBCP	Outer size x height 47HY = $\Phi$ 4.5 x 7.0 87HY = $\Phi$ 8.0 x 7.5 80HY = $\Phi$ 8.0 x 10.0 11HY = $\Phi$ 11.0 x 11.0 14HY = $\Phi$ 11.0 x 14.0	First two digits represent significant figures. Third digit specifies number of zeros.	Blank = None H = Presence (only for core sizes 87HY, 80HY and 11HY)	B = Bulk Blank = Tape & Reel

## Dimensions – Millimeters

### SBCP-47HY

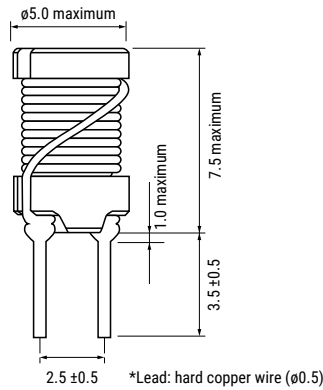

### Dimensions of Indented Square Hole Plastic Tape

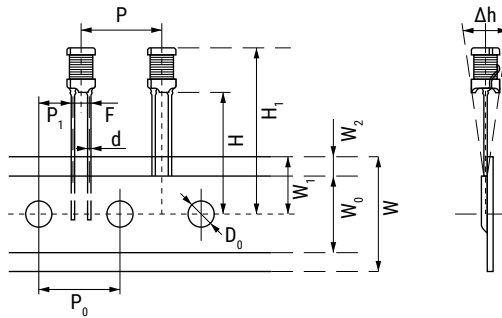

P	P <sub>0</sub>	P <sub>1</sub>	F	W	W <sub>0</sub>	W <sub>1</sub>	W <sub>2</sub>	H	H <sub>1</sub>	D <sub>0</sub>	d	Δh
±1.0	±0.3	±0.7	±0.5	+1.0, -0.5	Minimum	+0.75, -0.5	Maximum	+0.2, -0.0	Maximum	±0.2		±2.0
12.7	12.7	5.1	2.5	18.0	12.5	9.0	3.0	18.0	29.5	Ø 4.0	Ø 0.5	0.0

### SBCP-87HY

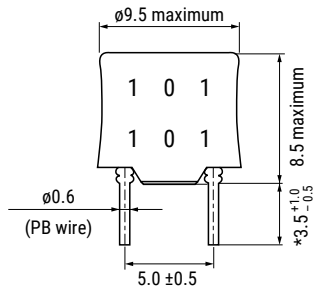

### Dimensions of Indented Square Hole Plastic Tape

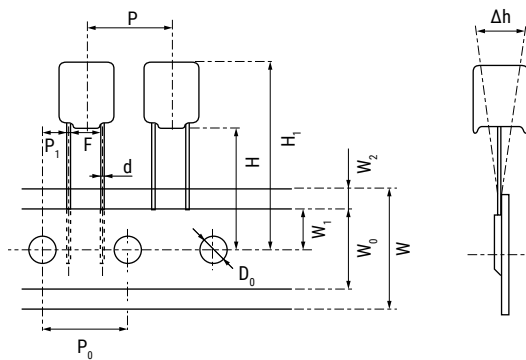

\* For bulk type  
\* Lead pitch is value at the root end.

P	P <sub>0</sub>	P <sub>1</sub>	F	W	W <sub>0</sub>	W <sub>1</sub>	W <sub>2</sub>	H	H <sub>1</sub>	D <sub>0</sub>	d	Δh
±1.0	±0.3	±0.7	±1.0	+1.0, -0.5	Minimum	+0.75, -0.5	Maximum	+0.2, -0.0	Maximum	±0.2		±2.0
12.7	12.7	3.85	5.0	18	12.5	9.0	3.0	18.0	28.5	Ø 4.0	Ø 0.6	0.0

## Dimensions – Millimeters cont'd

### SBCP-80HY

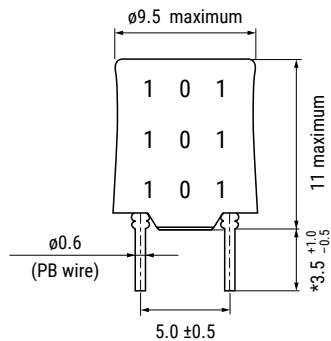

\* For bulk type  
\* Lead pitch is value at the root end.

### Dimensions of Indented Square Hole Plastic Tape

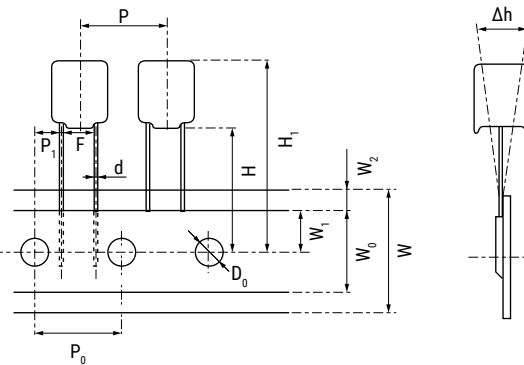

P	P <sub>0</sub>	P <sub>1</sub>	F	W	W <sub>0</sub>	W <sub>1</sub>	W <sub>2</sub>	H	H <sub>1</sub>	D <sub>0</sub>	d	Δh
±1.0	±0.3	±0.7	±1.0	+1.0, -0.5	Minimum	+0.75, -0.5	Maximum	+2.0, -0.0	Maximum	±0.2		±2.0
12.7	12.7	3.85	5.0	18.0	12.5	9.0	3.0	18.0	31.0	∅ 4.0	∅ 0.6	0.0

### SBCP-11HY

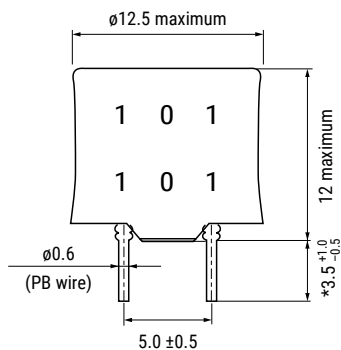

\* For bulk type  
\* Lead pitch is value at the root end.

### Dimensions of Indented Square Hole Plastic Tape

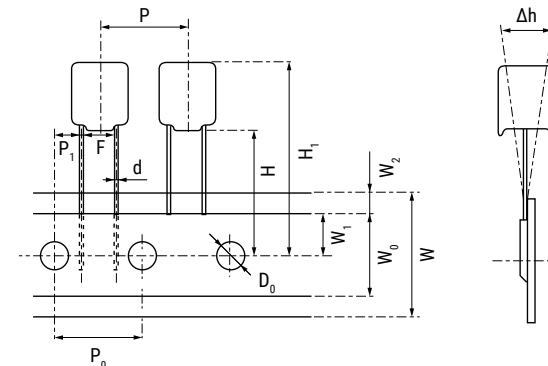

P	P <sub>0</sub>	P <sub>1</sub>	F	W	W <sub>0</sub>	W <sub>1</sub>	W <sub>2</sub>	H	H <sub>1</sub>	D <sub>0</sub>	d	Δh
±1.0	±0.3	±0.7	±1.0	+1.0, -0.5	Minimum	+0.75, -0.5	Maximum	+2.0, -0.0	Maximum	±0.2		±2.0
12.7	12.7	3.85	5.0	18.0	12.5	9.0	3.0	18.0	32.0	∅ 4.0	∅ 0.6	0.0

### SBCP-14HY

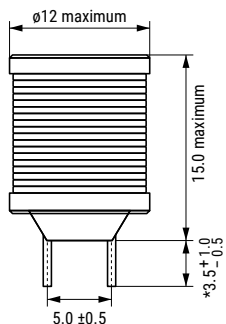

\*Lead: hard copper wire (∅0.6)

## Performance Characteristics

Series	Item	Performance Characteristics
SBCP-47HY	Operating temperature	-20°C to +105°C (including self-temperature rise)
	Rated inductance range	1.2 – 1,500 $\mu$ H at 10 kHz, 1 mA
	Inductance tolerance	$\pm$ 10% – $\pm$ 20%
	Rated DC resistance range	0.021 – 8.000 $\Omega$ maximum
	Rated current range	0.13 – 3.00 A
SBCP-87HY	Operating temperature	-20°C to +105°C (including self-temperature rise)
	Rated inductance range	1.0 – 1,000 $\mu$ H at 10 kHz, 1 mA
	Inductance tolerance	$\pm$ 10% – $\pm$ 30%
	Rated DC resistance range	0.02 – 2.82 $\Omega$ maximum
	Rated current range	0.25 – 4.50 A
SBCP-80HY	Operating temperature	-20°C to +105°C (including self-temperature rise)
	Rated inductance range	1.5 – 10,000 $\mu$ H at 10 kHz, 1 mA
	Inductance tolerance	$\pm$ 10% – $\pm$ 30%
	Rated DC resistance range	0.02 – 19.10 $\Omega$ maximum
	Rated current range	0.10 – 4.50 A
SBCP-11HY	Operating temperature	-20°C to +105°C (including self-temperature rise)
	Rated inductance range	1.5 – 1,000 $\mu$ H at 10 kHz, 1 mA
	Inductance tolerance	$\pm$ 10% – $\pm$ 30%
	Rated DC resistance range	0.02 – 1.70 $\Omega$ maximum
	Rated current range	0.42 – 5.00 A
SBCP-14HY	Operating temperature	-20°C to +105°C (including self-temperature rise)
	Rated inductance range	1.2 – 10,000 $\mu$ H at 10 kHz, 1 mA
	Inductance tolerance	$\pm$ 10% – $\pm$ 30%
	Rated DC resistance range	0.02 – 10.86 $\Omega$ maximum
	Rated current range	0.17 – 5.20 A

**Table 1A – Ratings & Part Number Reference**

Part Number	Inductance at 10 kHz, 1 mA (μH)	Inductance Tolerance	DC Resistance (Ω) Maximum	Rated Current (A)	Current (Reference Value) (A)			Weight (g)
					ΔT = 20°C	ΔT = 40°C	L – 10% (85°C)	
SBCP-47HY1R2B	1.2	±20%	0.021	3.00	3.02	4.26	4.16	0.500
SBCP-47HY1R5B	1.5	±20%	0.024	2.85	2.85	4.01	3.67	0.500
SBCP-47HY2R2B	2.2	±20%	0.029	2.60	2.59	3.66	3.20	0.500
SBCP-47HY2R7B	2.7	±20%	0.032	2.45	2.47	3.48	2.92	0.500
SBCP-47HY3R3B	3.3	±20%	0.037	2.30	2.28	3.21	2.70	0.500
SBCP-47HY3R9B	3.9	±20%	0.040	2.15	2.18	3.08	2.51	0.500
SBCP-47HY4R7B	4.7	±20%	0.043	2.10	2.10	2.96	2.30	0.500
SBCP-47HY5R6B	5.6	±20%	0.049	1.95	1.99	2.80	2.04	0.500
SBCP-47HY6R8B	6.8	±20%	0.052	1.90	1.92	2.71	1.93	0.470
SBCP-47HY8R2B	8.2	±20%	0.059	1.70	1.81	2.55	1.74	0.500
SBCP-47HY100B	10.0	±20%	0.067	1.60	1.69	2.38	1.60	0.470
SBCP-47HY120B	12.0	±20%	0.076	1.40	1.59	2.24	1.41	0.500
SBCP-47HY150B	15.0	±20%	0.087	1.25	1.48	2.09	1.26	0.500
SBCP-47HY220B	22.0	±20%	0.123	1.05	1.24	1.75	1.04	0.500
SBCP-47HY270B	27.0	±20%	0.137	0.96	1.18	1.66	0.96	0.500
SBCP-47HY330B	33.0	±20%	0.169	0.87	1.06	1.50	0.87	0.500
SBCP-47HY390B	39.0	±20%	0.213	0.79	1.95	1.33	0.79	0.500
SBCP-47HY470B	47.0	±10%	0.267	0.73	0.84	1.19	0.73	0.500
SBCP-47HY560B	56.0	±10%	0.350	0.65	0.65	0.87	0.66	0.500
SBCP-47HY680B	68.0	±10%	0.397	0.60	0.61	0.81	0.60	0.500
SBCP-47HY820B	82.0	±10%	0.519	0.53	0.53	0.71	0.55	0.500
SBCP-47HY101B	100.0	±10%	0.584	0.50	0.50	0.67	0.50	0.500
SBCP-47HY121B	120.0	±10%	0.657	0.45	0.47	0.63	0.45	0.500
SBCP-47HY151B	150.0	±10%	0.878	0.41	0.41	0.55	0.41	0.500
SBCP-47HY221B	220.0	±10%	1.100	0.33	0.36	0.48	0.33	0.500
SBCP-47HY271B	270.0	±10%	1.300	0.30	0.34	0.45	0.30	0.500
SBCP-47HY331B	330.0	±10%	1.800	0.27	0.29	0.39	0.27	0.457
SBCP-47HY391B	390.0	±10%	2.000	0.25	0.26	0.36	0.25	0.500
SBCP-47HY471B	470.0	±10%	2.800	0.22	0.22	0.31	0.23	0.500
SBCP-47HY561B	560.0	±10%	3.100	0.21	0.21	0.29	0.21	0.500
SBCP-47HY681B	680.0	±10%	3.500	0.19	0.20	0.28	0.19	0.500
SBCP-47HY821B	820.0	±10%	5.300	0.16	0.16	0.22	0.17	0.500
SBCP-47HY102B	1000.0	±10%	6.000	0.15	0.15	0.21	0.16	0.487
SBCP-47HY152B	1500.0	±10%	8.000	0.13	0.13	0.18	0.13	0.490

Part Number	Inductance at 10 kHz, 1 mA (μH)	Inductance Tolerance	DC Resistance (Ω) Maximum	Rated Current (A)	Current (Reference Value) (A)			Weight (g)
					ΔT = 20°C	ΔT = 40°C	L – 10% (85°C)	

**Table 1B – Ratings & Part Number Reference**

Part Number	Inductance at 10 kHz, 1 mA L (µH)	Inductance Tolerance	DC Resistance (Ω) Maximum	Rated Current (A) ΔT = 20°C	Current (Reference Value) (A)		Weight (g)
					ΔT = 40°C	L Change Rate -10%	
SBCP-87HY1R0H	1.0	±30%	0.02	4.50	6.30	10.20	1.600
SBCP-87HY2R2H	2.2	±30%	0.03	4.00	5.60	6.10	1.600
SBCP-87HY3R3H	3.3	±30%	0.03	3.20	4.40	4.80	1.600
SBCP-87HY4R7H	4.7	±20%	0.03	3.20	4.40	4.30	1.226
SBCP-87HY6R8H	6.8	±20%	0.04	2.80	3.90	3.40	1.325
SBCP-87HY100H	10.0	±20%	0.05	2.30	3.20	2.40	1.600
SBCP-87HY150H	15.0	±20%	0.06	2.10	2.90	2.20	1.600
SBCP-87HY220H	22.0	±20%	0.08	1.90	2.60	1.80	1.600
SBCP-87HY330H	33.0	±20%	0.12	1.50	2.10	1.50	1.600
SBCP-87HY470H	47.0	±20%	0.15	1.30	1.80	1.20	1.600
SBCP-87HY680H	68.0	±10%	0.19	1.16	1.60	1.00	1.600
SBCP-87HY820H	82.0	±10%	0.23	1.10	1.50	0.94	1.600
SBCP-87HY101H	100.0	±10%	0.30	0.90	1.20	0.87	1.600
SBCP-87HY151H	150.0	±10%	0.39	0.79	1.10	0.70	1.600
SBCP-87HY221H	220.0	±10%	0.57	0.65	0.91	0.57	1.600
SBCP-87HY331H	330.0	±10%	0.92	0.50	0.70	0.47	1.600
SBCP-87HY471H	470.0	±10%	1.30	0.42	0.58	0.39	1.600
SBCP-87HY681H	680.0	±10%	1.66	0.33	0.46	0.32	2.016
SBCP-87HY102H	1000.0	±10%	2.82	0.25	0.35	0.27	1.600
SBCP-80HY1R5H	1.5	±30%	0.02	4.50	6.30	13.50	1.800
SBCP-80HY2R2H	2.2	±30%	0.03	4.00	5.60	11.70	1.800
SBCP-80HY3R3H	3.3	±30%	0.04	3.60	5.00	9.20	1.800
SBCP-80HY4R7H	4.7	±20%	0.04	3.30	4.60	7.60	1.800
SBCP-80HY6R8H	6.8	±20%	0.05	3.30	4.60	6.50	1.800
SBCP-80HY100H	10.0	±20%	0.05	2.90	4.00	5.30	1.980
SBCP-80HY150H	15.0	±20%	0.08	2.50	3.50	4.00	1.800
SBCP-80HY220H	22.0	±20%	0.08	2.40	3.30	3.40	1.800
SBCP-80HY330H	33.0	±20%	0.09	2.10	2.90	2.70	1.800
SBCP-80HY470H	47.0	±10%	0.13	1.90	2.60	2.20	1.955
SBCP-80HY680H	68.0	±10%	0.16	1.70	2.30	1.80	2.500
SBCP-80HY820H	82.0	±10%	0.24	1.30	1.80	1.70	2.670
SBCP-80HY101H	100.0	±10%	0.35	1.10	1.50	1.60	2.060
SBCP-80HY121H	120.0	±10%	0.35	1.10	1.50	1.40	1.800
SBCP-80HY151H	150.0	±10%	0.41	1.00	1.40	1.20	1.800
SBCP-80HY221H	220.0	±10%	0.52	0.90	1.20	1.00	1.800
SBCP-80HY331H	330.0	±10%	0.75	0.70	0.98	0.85	2.215
SBCP-80HY471H	470.0	±10%	0.95	0.65	0.91	0.71	1.800
SBCP-80HY681H	680.0	±10%	1.40	0.50	0.70	0.58	1.800
SBCP-80HY102H	1000.0	±10%	1.89	0.40	0.56	0.48	2.400
SBCP-80HY122H	1200.0	±10%	2.60	0.32	0.44	0.45	2.400
SBCP-80HY103HB	10000.0	±10%	19.10	0.10	0.14	0.15	2.270
SBCP-11HY1R5H	1.5	±30%	0.02	5.00	7.20	25.30	3.300
SBCP-11HY2R2H	2.2	±30%	0.02	4.70	6.70	21.40	3.300
SBCP-11HY3R3H	3.3	±20%	0.02	4.40	6.30	18.50	3.300
SBCP-11HY4R7H	4.7	±20%	0.03	4.10	5.80	14.60	3.300
SBCP-11HY6R8H	6.8	±20%	0.03	3.60	5.10	12.10	3.300
SBCP-11HY100H	10.0	±20%	0.04	3.10	4.50	9.60	3.300
SBCP-11HY150H	15.0	±20%	0.05	2.80	4.10	7.90	3.300
SBCP-11HY220H	22.0	±20%	0.06	2.50	3.60	6.40	3.300
SBCP-11HY330H	33.0	±20%	0.07	2.30	3.30	5.40	3.300
SBCP-11HY470H	47.0	±20%	0.10	2.00	2.90	4.40	3.825
SBCP-11HY680H	68.0	±10%	0.12	1.80	2.60	3.60	3.300
SBCP-11HY101H	100.0	±10%	0.19	1.30	1.90	3.00	4.235
SBCP-11HY151H	150.0	±10%	0.26	1.10	1.60	2.40	3.300
SBCP-11HY221H	220.0	±10%	0.40	0.95	1.30	2.00	3.300
SBCP-11HY331H	330.0	±10%	0.60	0.74	1.00	1.60	3.300
SBCP-11HY471H	470.0	±10%	0.76	0.66	0.93	1.40	3.300
SBCP-11HY681H	680.0	±10%	1.00	0.55	0.77	1.10	4.440
SBCP-11HY102H	1000.0	±10%	1.70	0.42	0.60	0.96	3.300
Part Number	Inductance at 10 kHz, 1 mA L (µH)	Inductance Tolerance	DC Resistance (Ω) Maximum	Rated Current (A) ΔT = 20°C	Current (Reference Value) (A)		Weight (g)
					ΔT = 40°C	L Change Rate -10%	

**Table 1B – Ratings & Part Number Reference (cont.)**

Part Number	Inductance at 10 kHz, 1 mA L (μH)	Inductance Tolerance	DC Resistance (Ω) Maximum	Rated Current (A) ΔT = 20°C	Current (Reference Value) (A)		Weight (g)
					ΔT = 40°C	L Change Rate -10%	
SBCP-14HY1R2B	1.2	±30%	0.02	5.20	7.40	24.30	6.000
SBCP-14HY2R2B	2.2	±30%	0.02	4.35	5.11	16.82	6.000
SBCP-14HY3R3B	3.3	±30%	0.02	4.10	6.00	18.20	6.000
SBCP-14HY4R7B	4.7	±20%	0.03	3.60	5.07	14.36	6.000
SBCP-14HY6R8B	6.8	±20%	0.03	3.35	4.69	11.86	6.000
SBCP-14HY100B	10.0	±20%	0.04	3.00	4.20	10.30	6.000
SBCP-14HY150B	15.0	±20%	0.05	2.80	3.90	8.07	6.000
SBCP-14HY220B	22.0	±20%	0.06	2.70	3.73	6.94	6.000
SBCP-14HY330B	33.0	±20%	0.07	2.40	3.30	5.63	6.000
SBCP-14HY470B	47.0	±10%	0.09	1.90	2.74	4.58	6.000
SBCP-14HY680B	68.0	±10%	0.11	1.70	2.45	3.76	6.000
SBCP-14HY101B	100.0	±10%	0.14	1.50	2.15	3.10	6.000
SBCP-14HY151B	150.0	±10%	0.20	1.30	1.85	2.70	6.000
SBCP-14HY221B	220.0	±10%	0.31	1.05	1.51	2.20	5.650
SBCP-14HY331B	330.0	±10%	0.38	0.95	1.35	1.84	5.830
SBCP-14HY471B	470.0	±10%	0.54	0.80	1.10	1.48	6.000
SBCP-14HY681B	680.0	±10%	0.9	0.67	0.93	1.24	6.000
SBCP-14HY102B	1000.0	±10%	1.16	0.59	0.82	1.01	6.790
SBCP-14HY152B	1500.0	±10%	1.52	0.47	0.67	0.80	6.000
SBCP-14HY222B	2200.0	±10%	2.36	0.38	0.54	0.69	6.840
SBCP-14HY332B	3300.0	±10%	3.42	0.33	0.46	0.57	7.230
SBCP-14HY472B	4700.0	±10%	4.97	0.27	0.38	0.48	6.000
SBCP-14HY682B	6800.0	±10%	7.17	0.22	0.29	0.38	6.000
SBCP-14HY103B	10000.0	±10%	10.86	0.17	0.24	0.31	6.000

Part Number	Inductance at 10 kHz, 1 mA L (μH)	Inductance Tolerance	DC Resistance (Ω) Maximum	Rated Current (A) ΔT = 20°C	Current (Reference Value) (A)		Weight (g)
					ΔT = 40°C	L Change Rate -10%	
SBCP-14HY1R2B	1.2	±30%	0.02	5.20	7.40	24.30	6.000
SBCP-14HY2R2B	2.2	±30%	0.02	4.35	5.11	16.82	6.000
SBCP-14HY3R3B	3.3	±30%	0.02	4.10	6.00	18.20	6.000
SBCP-14HY4R7B	4.7	±20%	0.03	3.60	5.07	14.36	6.000
SBCP-14HY6R8B	6.8	±20%	0.03	3.35	4.69	11.86	6.000
SBCP-14HY100B	10.0	±20%	0.04	3.00	4.20	10.30	6.000
SBCP-14HY150B	15.0	±20%	0.05	2.80	3.90	8.07	6.000
SBCP-14HY220B	22.0	±20%	0.06	2.70	3.73	6.94	6.000
SBCP-14HY330B	33.0	±20%	0.07	2.40	3.30	5.63	6.000
SBCP-14HY470B	47.0	±10%	0.09	1.90	2.74	4.58	6.000
SBCP-14HY680B	68.0	±10%	0.11	1.70	2.45	3.76	6.000
SBCP-14HY101B	100.0	±10%	0.14	1.50	2.15	3.10	6.000
SBCP-14HY151B	150.0	±10%	0.20	1.30	1.85	2.70	6.000
SBCP-14HY221B	220.0	±10%	0.31	1.05	1.51	2.20	5.650
SBCP-14HY331B	330.0	±10%	0.38	0.95	1.35	1.84	5.830
SBCP-14HY471B	470.0	±10%	0.54	0.80	1.10	1.48	6.000
SBCP-14HY681B	680.0	±10%	0.9	0.67	0.93	1.24	6.000
SBCP-14HY102B	1000.0	±10%	1.16	0.59	0.82	1.01	6.790
SBCP-14HY152B	1500.0	±10%	1.52	0.47	0.67	0.80	6.000
SBCP-14HY222B	2200.0	±10%	2.36	0.38	0.54	0.69	6.840
SBCP-14HY332B	3300.0	±10%	3.42	0.33	0.46	0.57	7.230
SBCP-14HY472B	4700.0	±10%	4.97	0.27	0.38	0.48	6.000
SBCP-14HY682B	6800.0	±10%	7.17	0.22	0.29	0.38	6.000
SBCP-14HY103B	10000.0	±10%	10.86	0.17	0.24	0.31	6.000

**DC-Superposed Characteristics**

**SBCP-47HY**

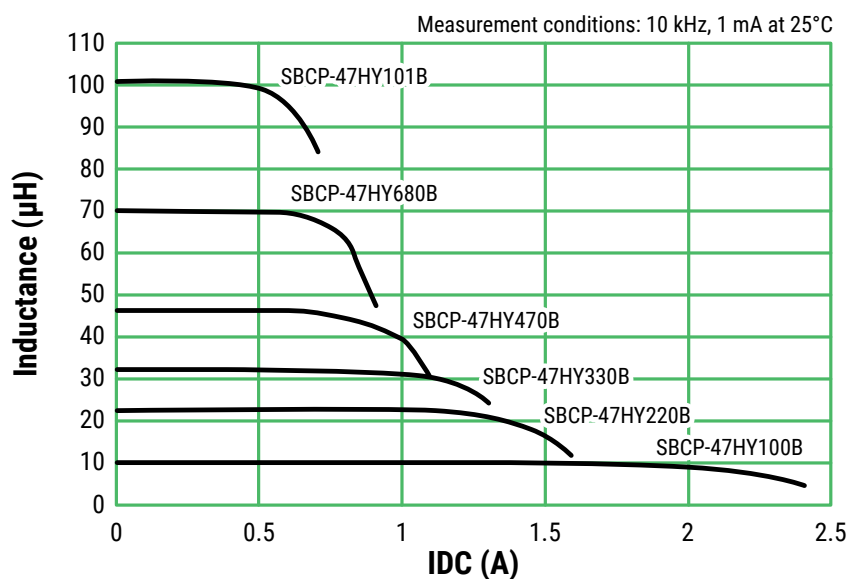

## DC-Superposed Characteristics (cont.)

### SBCP-14HY

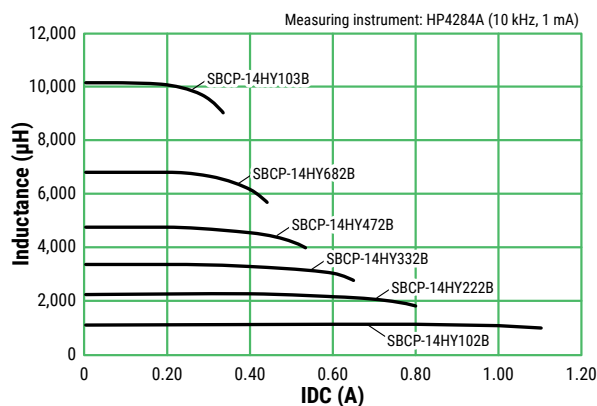
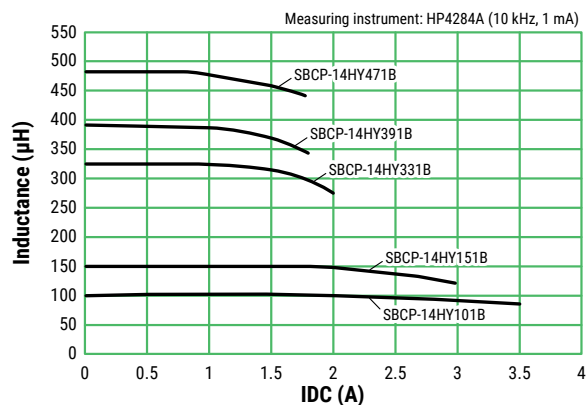
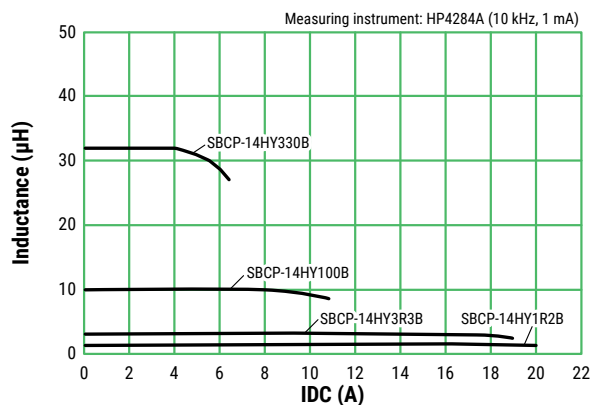

## Packaging

Series	Packaging Type	Pieces per Box
SBCP-47HY	Bulk	6,000
	Tape & Reel	4,000 <sup>1</sup>
SBCP-87HY	Bulk	4,000
	Tape & Reel	2,000 <sup>2</sup>
SBCP-80HY	Bulk	4,000
	Tape & Reel	2,000 <sup>2</sup>
SBCP-11HY	Bulk	2,000
	Tape & Reel	1,600 <sup>3</sup>
SBCP-14HY	Bulk	1,500

<sup>1</sup> The box contains 4 reels of 1,000 pieces each

<sup>2</sup> The box contains 4 reels of 500 pieces each

<sup>3</sup> The box contains 4 reels of 400 pieces each



## Handling Precautions

Inductors should be stored in normal working environments. While the inductors themselves are quite robust in other environments, solderability will be degraded by exposure to high temperatures, high humidity, corrosive atmospheres, and long-term storage.

KEMET recommends that maximum storage temperature not exceed 40°C and maximum storage humidity not exceed 70% relative humidity. Atmospheres should be free of chlorine and sulfur-bearing compounds. Temperature fluctuations should be minimized to avoid condensation on the parts. For optimized solderability, inductors' stock should be used promptly, preferably within six months of receipt.

---

## Export Control

### For customers in Japan

For products which are controlled items subject to the "Foreign Exchange and Foreign Trade Law" of Japan, the export license specified by the law is required for export.

### For customers outside Japan

Inductors should not be used or sold for use in the development, production, stockpiling or utilization of any conventional weapons or mass-destruction weapons (nuclear, chemical, biological weapons or missiles), or any other weapons.

## KEMET Electronics Corporation Sales Offices

For a complete list of our global sales offices, please visit [www.kemet.com/sales](http://www.kemet.com/sales).

---

### Disclaimer

All product specifications, statements, information and data (collectively, the "Information") in this datasheet are subject to change. The customer is responsible for checking and verifying the extent to which the Information contained in this publication is applicable to an order at the time the order is placed. All Information given herein is believed to be accurate and reliable, but it is presented without guarantee, warranty, or responsibility of any kind, expressed or implied.

Statements of suitability for certain applications are based on KEMET Electronics Corporation's ("KEMET") knowledge of typical operating conditions for such applications, but are not intended to constitute – and KEMET specifically disclaims – any warranty concerning suitability for a specific customer application or use. The Information is intended for use only by customers who have the requisite experience and capability to determine the correct products for their application. Any technical advice inferred from this Information or otherwise provided by KEMET with reference to the use of KEMET's products is given gratis, and KEMET assumes no obligation or liability for the advice given or results obtained.

Although KEMET designs and manufactures its products to the most stringent quality and safety standards, given the current state of the art, isolated component failures may still occur. Accordingly, customer applications which require a high degree of reliability or safety should employ suitable designs or other safeguards (such as installation of protective circuitry or redundancies) in order to ensure that the failure of an electrical component does not result in a risk of personal injury or property damage.

Although all product-related warnings, cautions and notes must be observed, the customer should not assume that all safety measures are indicated or that other measures may not be required.

*KEMET is a registered trademark of KEMET Electronics Corporation.*