



Connectors > Connector Backshells & Adapters > Ruggedized Backshells & Adapters



Connector General Specification Number: MIL-DTL-38999 Series I, MIL-DTL-38999 Series I/Class E,P,T, MIL-DTL-38999 Series I

/Class E,T, MIL-DTL-38999 Series II/Class E,P,T, MIL-DTL-38999 Series II/Class E,T, MIL-DTL-38999 Series II/Class T

Backshell Material: Aluminum

Adapter Plating Material: Cadmium (AMS-QQ-P-416, Type II, Class 3)

Cable Diameter Range: 3.2 – 5.1 mm [.125 – .2 in]

Adapter Angle: 90

Features

Product Type Features

Termination Device Included	TR04BI
Pluggable I/O Accessory Type	Tinel-Lock Adapter
Adapter Angle	90
Termination Device Type	Side-Entry Tinel-Lock Ring, Tinel-Lock Adapter, Tinel-Lock Ring
Connector Shell Size	12, 13

Body Features

Color	Olive Drab
Backshell Material	Aluminum
Adapter Plating Material	Cadmium (AMS-QQ-P-416, Type II, Class 3)
TE Adapter Code	41
Adapter Entry Size	4

Termination Features

Overbraid Termination	Tinel-Lock Ring
-----------------------	-----------------

Dimensions

Cable Entry Diameter	.2 – 6.4 mm [.01 – .25 in]
Cable Diameter Range	3.2 – 5.1 mm [.125 – .2 in]

Usage Conditions

Salt Spray Resistance	500 Hr
Operating Temperature Range	-65 – 175 °C[-85 – 347 °F]

Industry Standards

Connector Detail Specification Number	MS24266, MS27467, MS27468, MS27472, MS27473, MS27474, MS27479, MS27480, MS27481, MS27484, MS27497, MS27652, MS27653, MS27656, MS27661, MS27665
---------------------------------------	--

Other

Connector General Specification Number	MIL-DTL-38999 Series I, MIL-DTL-38999 Series I/Class E,P,T, MIL-DTL-38999 Series I/Class E,T, MIL-DTL-38999 Series II/Class E, P,T, MIL-DTL-38999 Series II/Class E,T, MIL-DTL-38999 Series II/Class T
--	--

Product Compliance

[For compliance documentation, visit the product page on TE.com>](#)

EU RoHS Directive 2011/65/EU	Not Compliant
EU ELV Directive 2000/53/EC	Not Compliant
China RoHS 2 Directive MIIT Order No 32, 2016	Restricted Materials Above Threshold
EU REACH Regulation (EC) No. 1907/2006	Current ECHA Candidate List: JUNE 2022 (224) Candidate List Declared Against: JUL 2021 (219) SVHC > Threshold: Pb (.3% in BODY & NUT) Cd (3% in BODY & NUT) Article Safe Usage Statements: Use personal protective equipment as required. Do not eat, drink or smoke when using this product. Wash thoroughly after handling. Recycle if possible and dispose of the article by following all applicable governmental regulations relevant to your geographic location.
Halogen Content	Low Halogen - Br, Cl, F, I < 900 ppm per homogenous material. Also BFR/CFR/PVC Free
Solder Process Capability	Not applicable for solder process capability

Product Compliance Disclaimer

This information is provided based on reasonable inquiry of our suppliers and represents our current actual knowledge based on the information they provided. This information is subject to change. The part numbers that TE has identified as EU RoHS compliant have a maximum concentration of 0.1% by weight in homogenous materials for lead, hexavalent chromium, mercury, PBB, PBDE, DBP, BBP, DEHP, DIBP, and 0.01% for cadmium, or qualify for an exemption to these limits as defined in the Annexes of Directive 2011/65/EU (RoHS2). Finished electrical and electronic equipment products will be CE marked as required by Directive 2011/65/EU. Components may not be CE marked. Additionally, the part numbers that TE has identified as EU ELV compliant have a maximum concentration of 0.1% by weight in homogenous materials for lead, hexavalent chromium, and mercury, and 0.01% for cadmium, or qualify for an exemption to these limits as defined in the Annexes of Directive 2000/53/EC (ELV). Regarding the REACH Regulation, the information TE provides on SVHC in articles for this part number is based on the latest European Chemicals Agency (ECHA) 'Guidance on

requirements for substances in articles' posted at this URL: <https://echa.europa.eu/guidance-documents/guidance-on-reach>

Compatible Parts



TE Part # 173643-000
RH-3960-1-TINEL-KIT-120V

Also in the Series | RAYCHEM TXR



Ruggedized Backshells & Adapters
(2071)



Screened Backshells & Adapters(1)

Customers Also Bought

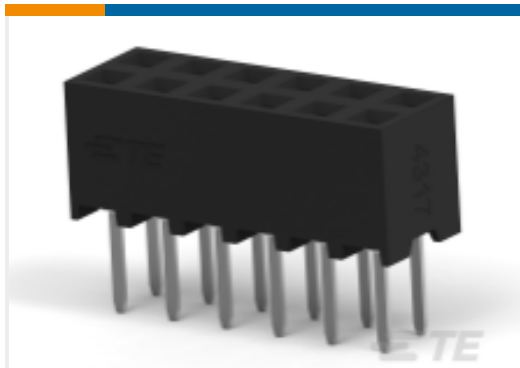

TE Part #1-2314821-4
14P,2MM,B-B,REC,DRVT,2.7,0.38AU,TB

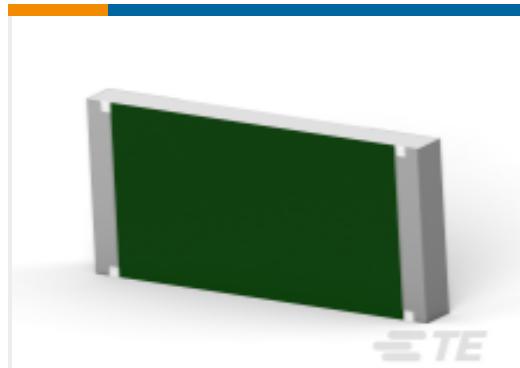

TE Part #4-2176404-6
3550 1M0 1%

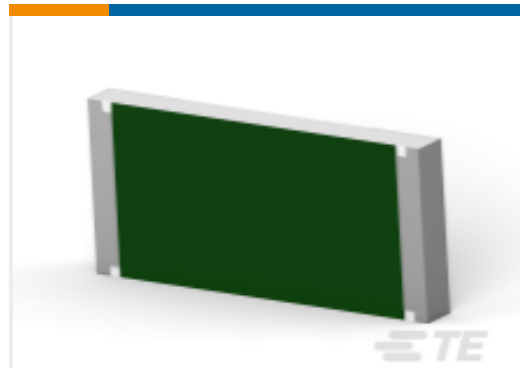

TE Part #2-2176405-7
3550 39K 5%

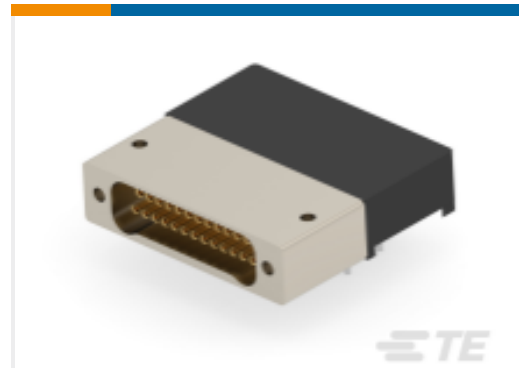

TE Part #1589743-6
STM025M51VQ = THRU-HOLE



TE Part #8-1589456-9
SSM005PC0DX024N = WDUALOBE

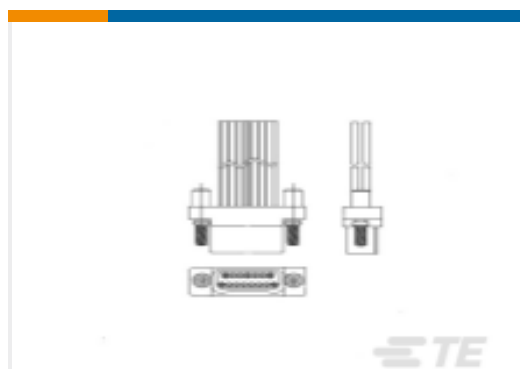

TE Part #1589474-4
STM025PC2DM006Q = WDUALOBE



TE Part #4-1589474-0
STM037PC2DC020Q = WDUALOBE

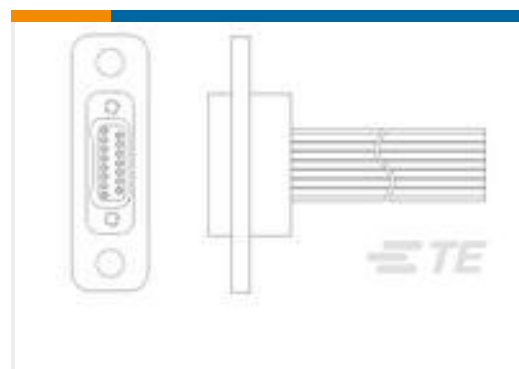

TE Part #1-1589050-2
PTS025SC2DM036Q = Panel Mount

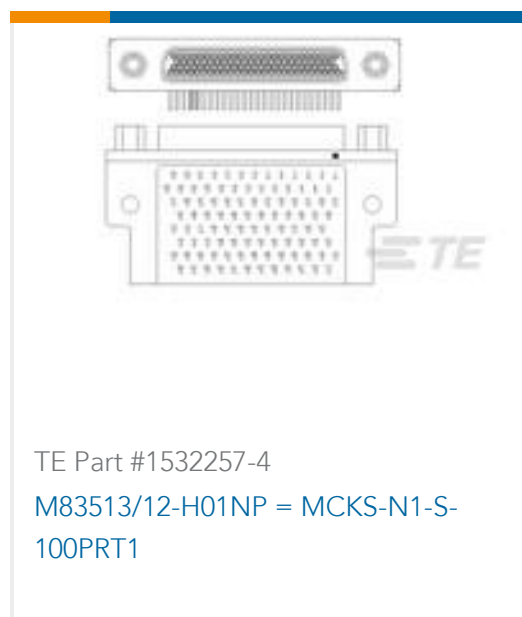

Documents

Product Drawings

[TXR41AB90-1204BI](#)

English

CAD Files

[3D PDF](#)

3D

[Customer View Model](#)

[ENG_CVM_CVM_CF5457-000_O.2d_dxf.zip](#)

English

[Customer View Model](#)

[ENG_CVM_CVM_CF5457-000_O.3d_igs.zip](#)

English

[Customer View Model](#)

[ENG_CVM_CVM_CF5457-000_O.3d_stp.zip](#)

English

By downloading the CAD file I accept and agree to the [Terms and Conditions](#) of use.

Datasheets & Catalog Pages

[5-1654025-5_sec6_Adapters](#)

English

Circular Backshells

English

Product Specifications

[General Information Package for Tinel-Lock Adapters](#)

English

[Product Specification](#)

English

[Braid termination using a Tinel Lock Ring installed using a resistance heater.](#)

French

[Braid termination using a Tinel Lock Ring installed using a resistance heater.](#)

English

[PERFORMANCE SPECIFICATION Tinel-Lock Rings, Heat Recoverable for Braid Termination](#)

English



ASSEMBLY GUIDE for Tinel -Lock Rings, Heat Recoverable for Braid Termination

English

Instruction Sheets

[Instruction Sheet \(U.S.\)](#)

English