

Verpackt in Gurtverpackung  
 Tape on Reel Packaging  
 Verpackungseinheit: 1000 Stück  
 Packaging unit: 1000 pcs

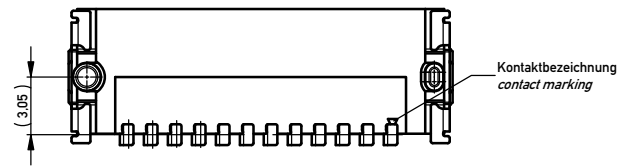
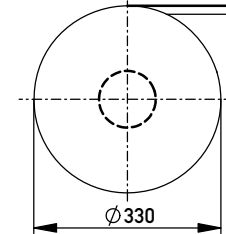

Anforderungsstufe 1  
 Performance Level 1

Kontaktbereich vergoldet  
 Mating Area gold plating

Anschlussbereich verzinkt 4-6 µm  
 Terminal Area 4-6 µm tin plating

Koplanarität der Anschlüsse ≤ 0,1 mm  
 Coplanarity Area of Termination ≤ 0,1 mm

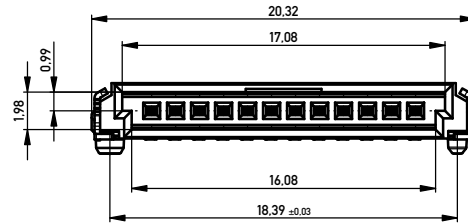

Abspulrichtung - Reel off Direction

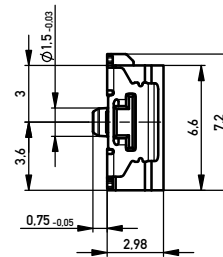
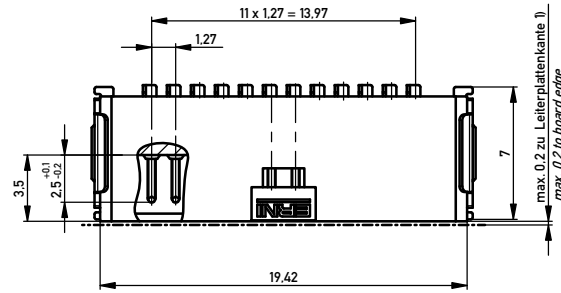
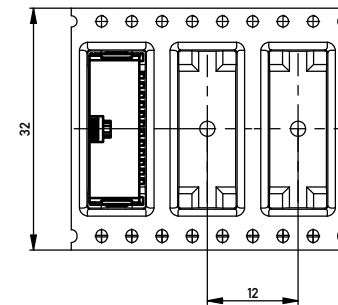

Leiterplatten-Layout für SMT  
 PCB-Layout for SMT

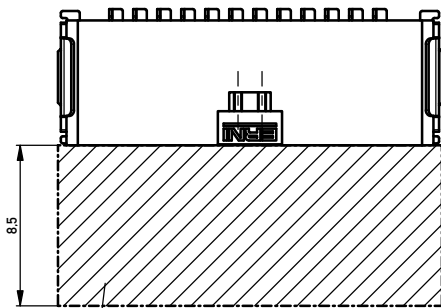

Sperrfläche für Leiterbahnen  
 gültig bei Verwendung von  
 Gegenstecker Federleiste 90°  
 in SKV Ausführung  
 Restricted area for conductors  
 valid for use by mating  
 female connector 90°  
 in IDC version

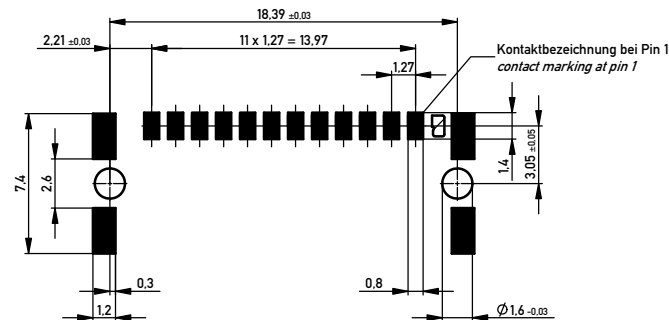

1) gültig bei Verwendung von Gegenstecker Federleiste 90° in SMD Ausführung  
 valid for use by mating female connector 90° in SMD version

Information:	Tolerances	Scale 5:1	
All rights reserved. Only for Information. To ensure that this is the latest version of this drawing, please contact one of the ERNI companies before using.	Subject to modification without prior notice. Drawing will not be updated.	All Dimensions in mm	Designation <b>M 1.27 SRC A, 12-polig BA1</b>
e	15.05.2013	ERNI www.ERNI.com	<b>234478</b>
Index	Date		Class A2
			SRCA

Copyright by ERNI GmbH  
 Proprietary notice pursuant to ISO 16949 to be observed